

ELECTRONIC SNAP CIRCUITS®

Projects 512-692

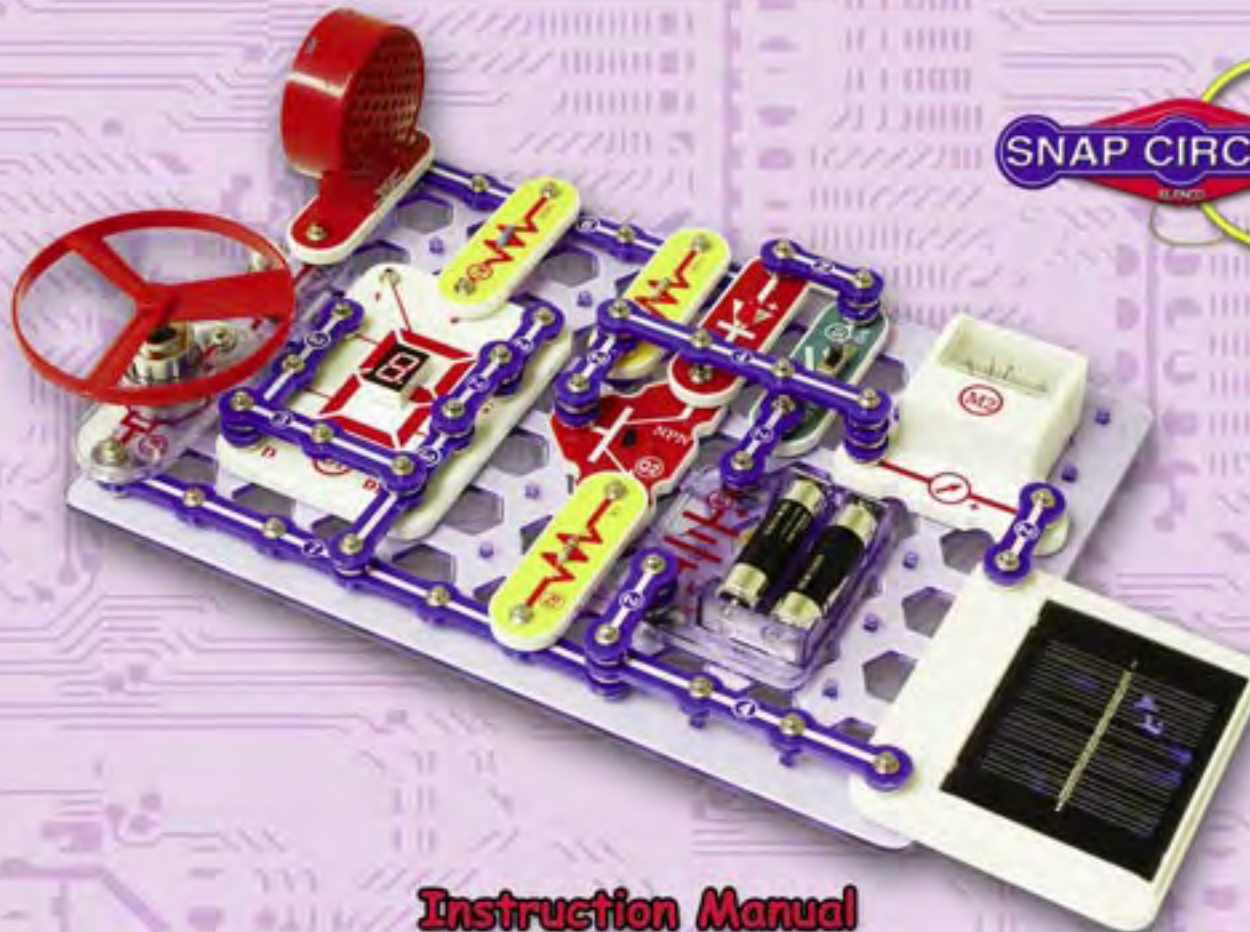

Instruction Manual

Elenco® Electronics, Inc.

Table of Contents

Basic Troubleshooting	1	MORE DO's and DON'Ts of Building Circuits	5
Parts List	2	Project Listings	6, 7
About the Two-Spring Socket (?1)	3	Projects 512-692	8 - 84
MORE About Your Snap Circuits® Parts	4	Other Fun Elenco® Products	85 - 86
MORE Advanced Troubleshooting	4		

 **WARNING TO ALL PARTS WITH A  SYMBOL** - Moving parts. Do not touch the motor or fan during operation.  Do not lean over the motor. Do not launch the fan at people, animals, or objects. Eye protection is recommended.

 **WARNING: SHOCK HAZARD** - Never connect Snap Circuits® to the electrical outlets in your home in any way!

 **WARNING: CHOKING HAZARD** - Small parts. Not for children under 3 years.

WARNING: Always check your wiring before turning on a circuit. Never leave a circuit unattended while the batteries are installed. Never connect additional batteries or any other power sources to your circuits. Discard any cracked or broken parts.

Basic Troubleshooting

- Most circuit problems are due to incorrect assembly. Always double-check that your circuit exactly matches the drawing for it.
- Be sure that parts with positive/negative markings are positioned as per the drawing.
- Sometimes the light bulbs come loose, tighten them as needed. Use care since glass bulbs can shatter.
- Be sure that all connections are securely snapped.
- Try replacing the batteries.
- If the motor spins but does not balance the fan, check the black plastic piece with three prongs on the motor shaft. Be sure that it is at the top of the shaft.

Elenco® Electronics is not responsible for parts damaged due to incorrect wiring.

Note: If you suspect you have damaged parts, you can follow the Advanced Troubleshooting procedure on page 5 to determine which ones need replacing.

Batteries:

- Use only 1.5V AA type, alkaline batteries (not incl.).
- Insert batteries with correct polarity.
- Non-rechargeable batteries should not be recharged. Rechargeable batteries should only be charged under adult supervision, and should not be recharged while in the product.
- Do not mix alkaline, standard (carbon-zinc), or rechargeable (nickel-cadmium) batteries.
- Do not mix old and new batteries.
- Remove batteries when they are used up.
- Do not short circuit the battery terminals.
- Never throw batteries in a fire or attempt to open its outer casing.
- Batteries are harmful if swallowed, so keep away from small children.

Review of How To Use It

(See p.3 of the Projects 1-101 manual for more details.)

The Snap Circuits® kit uses building blocks with snaps to build the different electrical and electronic circuits in the projects. These blocks are in different colors and have numbers on them so that you can easily identify them. The circuit you will build is shown in color and with numbers, identifying the blocks that you will use and snap together to form a circuit.

Next to each part in every circuit drawing is a small number in black. This tells you which level the component is placed at. Place all parts on level 1 first, then all of the parts on level 2, then all of the parts on level 3, etc.

A large clear plastic base grid is included with this kit to help keep the circuit block together. The base has rows labeled A-G and columns labeled 1-10.

Install two (2) "AA" batteries (not included) in the battery holder (B1). The 2.5V and 6V bulbs come packaged separate from their sockets. Install the 2.5V bulb in the L1 lamp socket, and the 6V bulb in the L2 lamp socket.

Place the fan on the motor (M1) whenever that part is used, unless the project you are building says not to use it.





Some circuits use the red and black jumper wires to make unusual connections. Just clip them to the metal snaps or as indicated.

Note: While building the projects, be careful not to accidentally make a direct connection across the battery holder (a "short circuit"), as this may damage and/or quickly drain the batteries.

Parts List (Colors and styles may vary) Symbols and Numbers

Note: There are additional part lists in your other project manuals. Part designs are subject to change without notice.

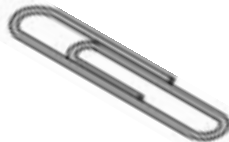
Important: If any parts are missing or damaged, **DO NOT RETURN TO RETAILER.** Call toll-free (800) 533-2441 or e-mail us at: help@elenco.com. Customer Service • 150 Carpenter Ave. • Wheeling, IL 60090 U.S.A.

Qty.	ID	Name	Symbol	Part #
□ 1	(B2)	Solar Cell		6SCB2
□ 1 □ 1	(M3)	Electromagnet Iron Core Rod		6SCM3 6SCM3B
□ 1	(S4)	Vibration Switch		6SCS4
□ 1		Bag of Paperclips		6SCM3P
□ 1	(?1)	Two-spring Socket		6SCPY1

You may order additional / replacement parts at our website: www.snapcircuits.net

About the TWO-SPRING SOCKET (?1)

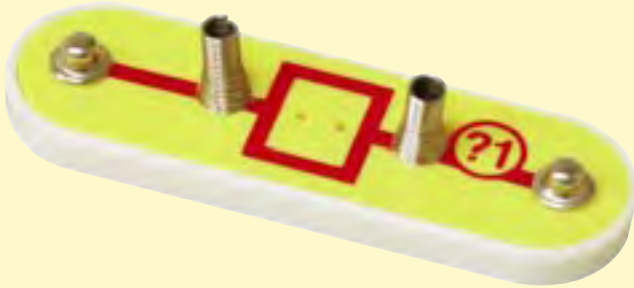

The two-spring socket (?1) just has two springs, and won't do anything by itself. It is not used in any of the experiments. It was included to make it easy to connect other electronic components to your Snap Circuits®. It should only be used by advanced users who are creating their own circuits.

There are many different types of electronic components and basic parts like resistors and capacitors have a wide range of available values. For example, Snap Circuits® includes five fixed-value resistors (100Ω, 1KΩ, 5.1KΩ, 10KΩ, and 100KΩ). This is a very limited choice of values, and difficult to design circuits with. Snap Circuits® also includes an adjustable resistor (RV), but it is difficult to set this part to a particular value. You can place your resistors in series and parallel to make different values (as is done with the 5.1KΩ and 10KΩ in project #166), but this is also difficult with only five values to choose from.

Many customers like to create their own circuits and asked us to include more resistor values with Snap Circuits®. We could have done that, but you would never have enough. And resistors are not very exciting components by themselves. You could try to use your own resistors, but they are difficult to connect since normal electronic parts come with wires on them instead of snaps.

The two-spring socket (?1) makes it easy to connect your own resistors (and other parts) to circuits by connecting them between the springs:



Any component with two wires coming from it (called leads) can be connected with the two-spring socket (?1), assuming the leads are long enough. Usually you will connect different values of resistors or capacitors, but other components like LED's, diodes, or coils/inductors can also be used. You can usually find electronic components at any store specializing in electronics.

You can design your own circuits or substitute new parts into the projects in the manuals. For LED's, diodes, or electrolytic capacitors, be sure to connect your parts using the correct polarity or you may damage them. Never exceed the voltage ratings of any parts. Never connect to external voltage sources. ELENCO® ELECTRONICS IS NOT RESPONSIBLE FOR ANY PARTS DAMAGED BY IMPROPER CIRCUIT DESIGN OR WIRING. **The two-spring socket is only intended for advanced users.**

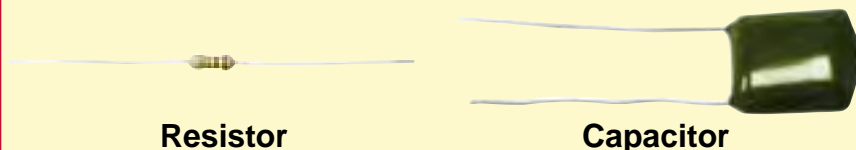

MORE About Your Snap Circuits® Parts

(Note: There is additional information in your other project manuals).

Our Student Guides give much more information about your parts, along with a complete lesson in basic electronics. See www.snapcircuits.net/learn.htm for more information.

The **solar cell (B2)** contains positively and negatively charged silicon crystals, arranged in layers that cancel each other out. When sunlight shines on it, charged particles in the light unbalance the silicon layers and produce an electrical voltage (about 3V). The maximum current depends on how the type of light and its brightness, but will be much less than a battery can supply. Bright sunlight works best, but incandescent light bulbs also work.

The **electromagnet (M3)** is a large coil of wire, which acts like a magnet when a current flows through it. Placing an iron bar inside increases the magnetic effects. Note that magnets can erase magnetic media like floppy discs.

When shaken, the **vibrator switch (S4)** contains two separate contacts; and a spring is connected to one of them. A vibration causes the spring to move, briefly connecting the two contacts.

The **two-spring socket (?1)** is described on page 3.

A Note on Sun Power

The sun produces heat and light on an immense scale, by transforming Hydrogen gas into Helium gas. This "transformation" is a thermonuclear reaction, similar to the explosion of a Hydrogen bomb. The earth is protected from most of this heat and radiation by being so far away, and by its atmosphere. But even here the sun still has power, since it can spin the motor on your kit and give you sunburn on a hot day.

Nearly all of the energy in any form on the surface of the earth originally came from the sun. Plants get energy for growth from the sun using a process called photosynthesis. People and animals get energy for growth by eating plants (and other animals). Fossil fuels such as oil and coal that power most of our society are the decayed remains of plants from long ago. These fuels exist in large but limited quantity, and are rapidly being consumed. Solar cells will produce electricity as long as the sun is bright, and will have an ever-increasing effect on our lives.

MORE Advanced Troubleshooting (Adult supervision recommended)

Elenco® Electronics is not responsible for parts damaged due to incorrect wiring.

If you suspect you have damaged parts, you can follow this procedure to systematically determine which ones need replacing:

1 - 28. Refer to the other project manuals for testing steps 1-28, then continue below.

29. **Solar Cell (B2):** Build the mini-circuit shown here and set the meter (M2) to the LOW (or 10mA) setting. Hold the circuit near a lamp and the meter pointer should move.

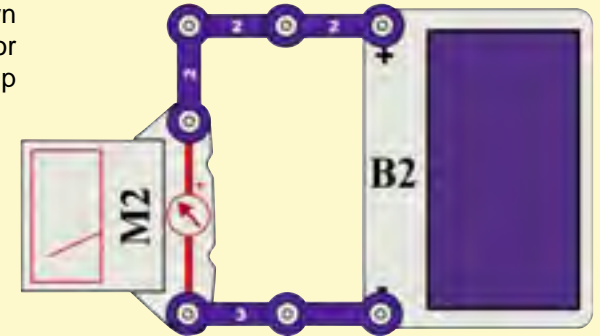

30. **Electromagnet (M3):** Build the mini-circuit shown here. Lamp (L1) must be dim, and must get brighter when you press the press switch (S2).

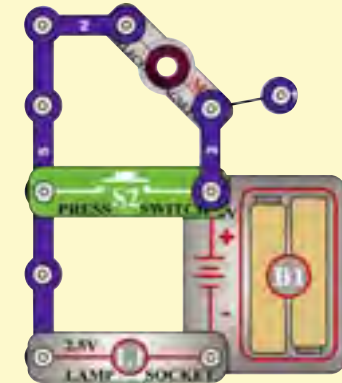

31. **Vibration Switch (S4):** Build the mini-circuit shown here and shake the base grid. The LED should go on and off as you shake.

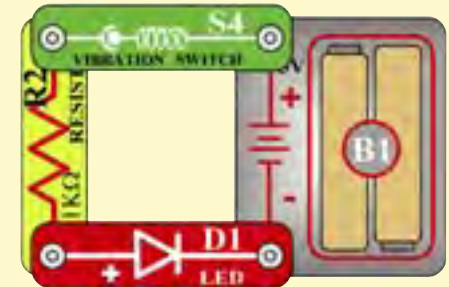

MORE DO's and DON'Ts of Building Circuits

After building the circuits given in this booklet, you may wish to experiment on your own. Use the projects in this booklet as a guide, as many important design concepts are introduced throughout them. Every circuit will include a power source (the batteries), a resistance (which might be a resistor, lamp, motor, integrated circuit, etc.), and wiring paths between them and back. **You must be careful not to create "short circuits" (very low-resistance paths across the batteries, see examples below) as this will damage components and/or quickly drain your batteries.** Only connect the IC's using configurations given in the projects, incorrectly doing so may damage them. **Elenco® Electronics is not responsible for parts damaged due to incorrect wiring.**

Here are some important guidelines:

- ALWAYS** use eye protection when experimenting on your own.
- ALWAYS** include at least one component that will limit the current through a circuit, such as the speaker, lamp, whistle chip, capacitors, ICs (which must be connected properly), motor, microphone, photo resistor, or fixed resistors.
- ALWAYS** use the **7-segment display**, LED's, transistors, the high frequency IC, the **SCR**, the antenna, and switches **in conjunction with other components that will limit the current through them.** Failure to do so will create a short circuit and/or damage those parts.
- ALWAYS** connect the adjustable resistor so that if set to its 0 setting, the current will be limited by other components in the circuit.
- ALWAYS** connect position capacitors so that the "+" side gets the higher voltage.
- ALWAYS** disconnect your batteries immediately and check your wiring if something appears to be getting hot.
- ALWAYS** check your wiring before turning on a circuit.
- ALWAYS** connect **ICs, the FM module, and the SCR** using configurations given in the projects or as per the connection descriptions for the parts.
- NEVER** try to use the high frequency IC as a transistor (the packages are similar, but the parts are different).
- NEVER** use the 2.5V lamp in a circuit with both battery holders unless you are sure that the voltage across it will be limited.
- NEVER** connect to an electrical outlet in your home in any way.
- NEVER** leave a circuit unattended when it is turned on.
- NEVER** touch the motor when it is spinning at high speed.

For all of the projects given in this book, the parts may be arranged in different ways without changing the circuit. For example, the order of parts connected in series or in parallel does not matter — what matters is how combinations of these sub-circuits are arranged together.

Warning to Snap Rover owners: Do not connect your parts to the Rover body except when using our approved circuits, the Rover body has a higher voltage which could damage your parts.

Examples of SHORT CIRCUITS - NEVER DO THESE!!!

Placing a 3-snap wire directly across the batteries is a **SHORT CIRCUIT.**



This is also a **SHORT CIRCUIT.**

When the slide switch (S1) is turned on, this large circuit has a **SHORT CIRCUIT** path (as shown by the arrows). The short circuit prevents any other portions of the circuit from ever working.

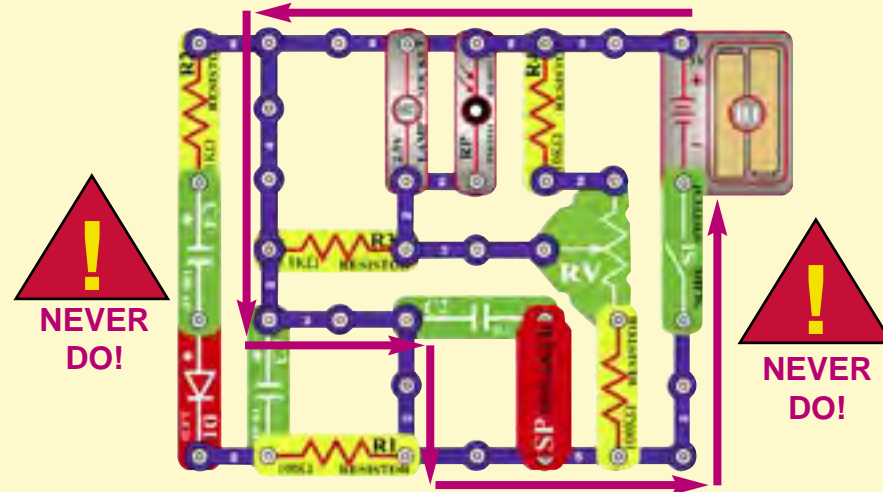

Elenco Electronics.

WARNING: SHOCK HAZARD - Never connect Snap Circuits® to the electrical outlets in your home in any way!

Project Listings

Project #	Description	Page #	Project #	Description	Page #	Project #	Description	Page #
512	Siren	8	546	6V Lamp Current	23	580	U2 with Transistor Amplifier (II)	37
513	Electronic Rain	8	547	Combined Lamp Circuits	23	581	U1 with Transistor Amplifier	37
514	Leaky Faucet	9	548	Rechargeable Battery	24	582	Loud Sounds	38
515	Lamp & Fan Independent	9	549	Solar Batteries	24	583	Swinging Meter with Sound	38
516	Drawing Resistors	10	550	Solar Control	25	584	Motor Sound Using Transformer	39
517	Electronic Kazoo	11	551	Solar Resistance Meter	25	585	Motor Sound with LED	39
518	Electronic Kazoo (II)	11	552	Solar Diode Tester	25	586	Motor Sound with LED (II)	39
519	Water Resistor	12	553	Solar NPN Transistor Tester	26	587	AC & DC Current	40
520	Two-Transistor Oscillator	12	554	Solar PNP Transistor Tester	26	588	Noisemaker	40
521	Diode	13	555	Solar Cell vs. Battery	27	589	AC Voltage	41
522	Rectifier	13	556	Solar Cell vs. Battery (II)	27	590	AC Voltage (II)	41
523	Motor Rectifier	14	557	Solar Music	28	591	AC Voltage (III)	42
524	SCR Shutdown	14	558	Solar Sounds Combo	28	592	Noisemaker (II)	42
525	SCR Motor Control	15	559	Solar Alarm	29	593	Noisemaker (III)	43
526	Output Forms	15	560	Better Solar Alarm	29	594	Pulsing Motor	43
527	Transistor AM Radio	16	561	Photo Solar Alarm	30	595	Noisemaker (IV)	44
528	Adjustable Solar Power Meter	16	562	Solar Space War	30	596	Noisemaker (V)	44
529	Fan Blade Storing Energy	17	563	Solar Music Alarm Combo	31	597	Noisemaker (VI)	44
530	Antenna Storing Energy	17	564	Solar Music Space War Combo	31	598	Noisemaker (VII)	44
531	Electromagnet Storing Energy	17	565	Solar Music Space War Combo (II)	31	599	Noisemaker (VIII)	44
532	Transformer Storing Energy	18	566	Solar Periodic Lights	32	600	Noisemaker (IX)	44
533	Relay Storing Energy	18	567	Solar Periodic Lights (II)	32	601	Alarm Power	45
534	Transformer Lights	18	568	Solar AM Radio Transmitter	32	602	Alarm Power (II)	45
535	Machine Siren	19	569	Low Light Noisemaker	33	603	Night Sounds	45
536	Hear the Motor	19	570	Low Light Noisemaker (II)	33	604	Mega Pulser and Flasher	46
537	Back EMF	20	571	Low Light Noisemaker (III)	33	605	"E" & "S" Blinker	46
538	Back EMF (II)	20	572	Solar Oscillator	34	606	"2" & "3" Blinker	47
539	Electronic Sound	21	573	Solar Oscillator (II)	34	607	"9" & "0" Blinker	47
540	Electronic Sound (II)	21	574	Daylight SCR Lamp	34	608	"3" & "6" Blinker	48
541	Lighthouse	21	575	Solar Bird Sounds	35	609	"c" & "C" Blinker	48
542	Diode Wonderland	22	576	Solar Bird Sounds (II)	35	610	"O" & "o" Blinker	49
543	Meter Ranges	22	577	SCR Solar Bomb Sounds	36	611	"b" & "d" Blinker	49
544	Motor Current	23	578	Flashing Laser LED's with Sound	36	612	"H" & "L" Blinker	50
545	2.5V Lamp Current	23	579	U2 with Transistor Amplifier	37	613	"A" & "o" Blinker	50

Project Listings

Project #	Description	Page #	Project #	Description	Page #	Project #	Description	Page #
614	Open & Closed Indicator	51	648	Low Pitch Oscillator (II)	64	679	Machine Gun Paperclip Vibrator	78
615	Open & Closed Indicator (II)	51	649	Low Pitch Oscillator (III)	64	680	Alarm Vibrator w/ LED	79
616	Vibration Indicator	51	650	Segment Jumper	65	681	Alarm Vibrator w/ LED (II)	79
617	Vibration Sounder	52	651	DP & Zero Flasher	65	682	Relay-Whistle Vibrator	80
618	SCR Noise Circuit	52	652	Stepper Motor with Lamp & LED's	66	683	Relay-Whistle Photo Vibrator	80
619	SCR & Transistor Switch	53	653	IC Start & Stop	66	684	Vibration LED	81
620	Two-speed Motor	53	654	IC Motor Speed	67	685	Vibration Speaker	81
621	Two-speed Motor (II)	54	655	Sound & Light Flasher	67	686	Measure the Vibration as You Tap the Switch	81
622	Current Flow	54	656	Electromagnet Delayer	68	687	Shaky Birthday Song	82
623	AM Radio with Power LED's	55	657	Electromagnet Delayer (II)	68	688	Vibration Detector	82
624	Space War IC Recording	55	658	Two-Lamp Electromagnet Delayer	69	689	Out of Balance	83
625	LED Flasher	56	659	Electromagnet Current	69	690	Vibration Alarm	83
626	LED Flasher with Sound	56	660	Electromagnetism	70	691	Vibration Space War	84
627	LED Flasher with Sound (II)	56	661	Electromagnetism & Compass	70	692	Vibration Light	84
628	Stepper Motor	57	662	Electromagnetism & Paperclips	71			
629	Crazy Music IC	57	663	Electromagnet Suction	71			
630	Stepper Motor w/ Sound	58	664	Electromagnet Tower	72			
631	Stepper Motor w/ Light	58	665	Paperclip Compass	72			
632	Police Siren with Display	58	666	Adjustable Paperclip Suspension	73			
633	Oscillator Alarm	59	667	Adjustable Paperclip w/ Delay	73			
634	Oscillator Alarm (II)	59	668	Photoresistor Paperclip Suspension	74			
635	Tapping U3	59	669	Paperclip Oscillator	74			
636	Tapping U3 (II)	59	670	Paperclip Oscillator (II)	75			
637	Adjustable Beeper	60	671	Paperclip Oscillator (III)	75			
638	Electronic Meow	60	672	Paperclip Oscillator (IV)	76			
639	Electronic Meow (II)	60	673	Paperclip Oscillator (V)	76			
640	Strobe Light	61	674	Oscillating Compass	76			
641	AND Gate	61	675	High Frequency Vibrator	77			
642	NAND Gate	62	676	High Frequency Vibrator (II)	77			
643	OR Gate	62	677	Siren Paperclip Vibrator	78			
644	NOR Gate	63	678	Alarm Paperclip Vibrator	78			
645	XOR Gate	63						
646	High Pitch Oscillator	64						
647	Low Pitch Oscillator	64						



Project #512

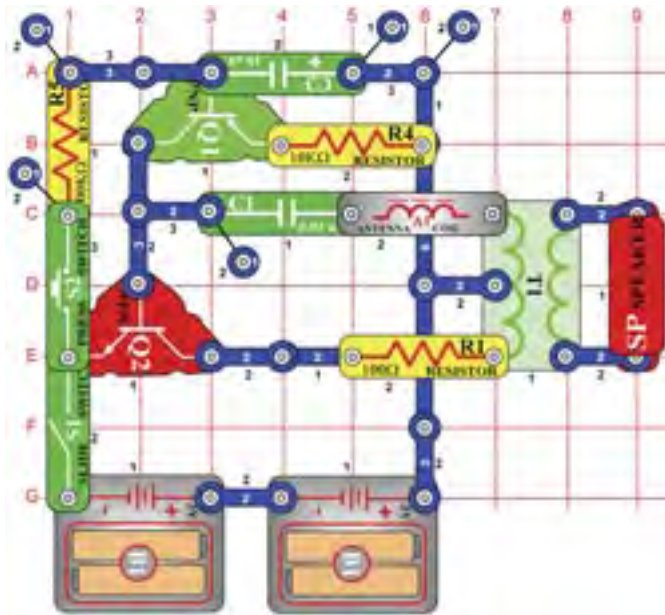

Siren

OBJECTIVE: *To make a siren that slowly starts up and fades away.*

Turn on the slide switch (S1), and then press the press switch (S2) for a few seconds and release. A siren starts up and then slowly fades away as the 10µF capacitor (C3) discharges.



Project #513

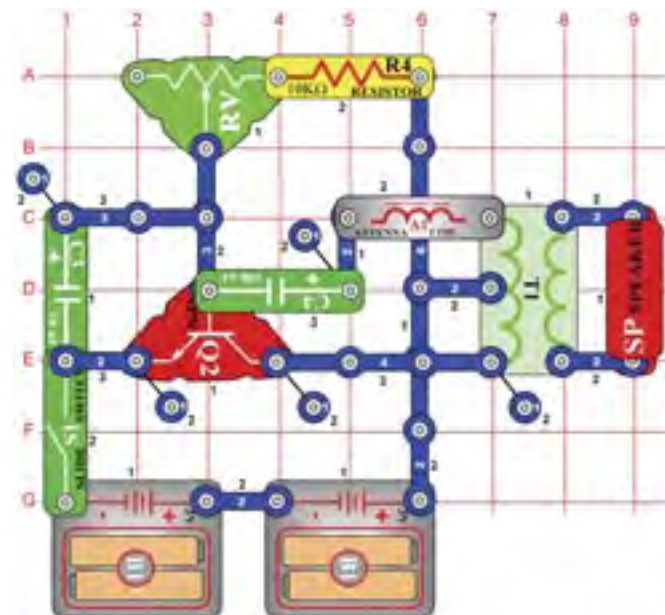

Electronic Rain

OBJECTIVE: *To make a low-frequency oscillator.*

Build the circuit and turn on the slide switch (S1), you hear a sound like raindrops. The adjustable resistor (RV) controls the rain. Turn it to the left to make a drizzle and turn to the right to make the rain come pouring down.

You can replace the 10KΩ resistor (R4) with the 1KΩ (R2) or 5.1KΩ (R3) resistors to speed up the rain.



Project #514

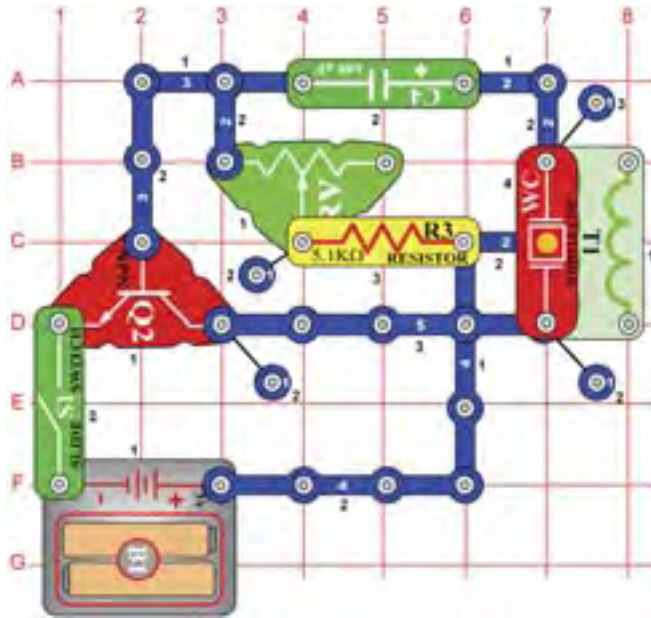

Leaky Faucet

OBJECTIVE: *To make a low-frequency oscillator.*

Build the circuit and set the adjustable resistor (RV) control all the way to the right. Turn on the slide switch (S1) and you hear a sound like a faucet dripping. You can speed up the dripping by moving the adjustable resistor control around.



Project #515

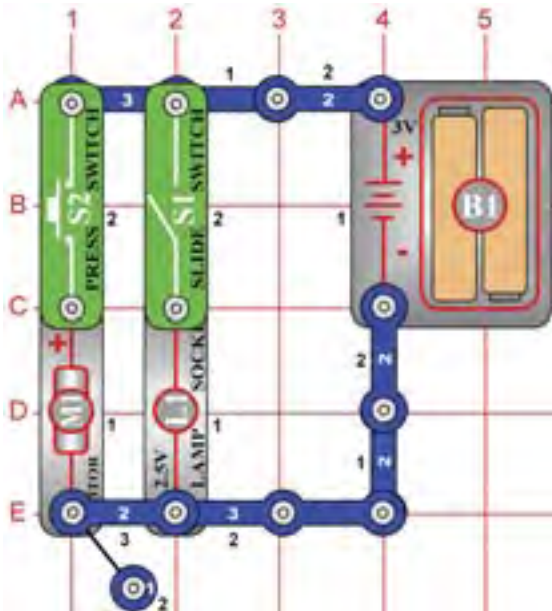

Lamp & Fan Independent

OBJECTIVE: *To show how switches allow circuits to operate independently even though they have the same power source.*

This circuit combines projects #1, #2, and #6 into one circuit.

Build the circuit and place the fan on the motor (M1). Depending on which of the switches (S1 & S2) are on, you can turn on either the lamp (project #1), the motor (project #2), or both together (project #6).



WARNING: Moving parts. Do not touch the fan or motor during operation.

This circuit was suggested by Luke S. of Westborough, MA.



Project #516

Drawing Resistors

OBJECTIVE: *To make your own resistors.*

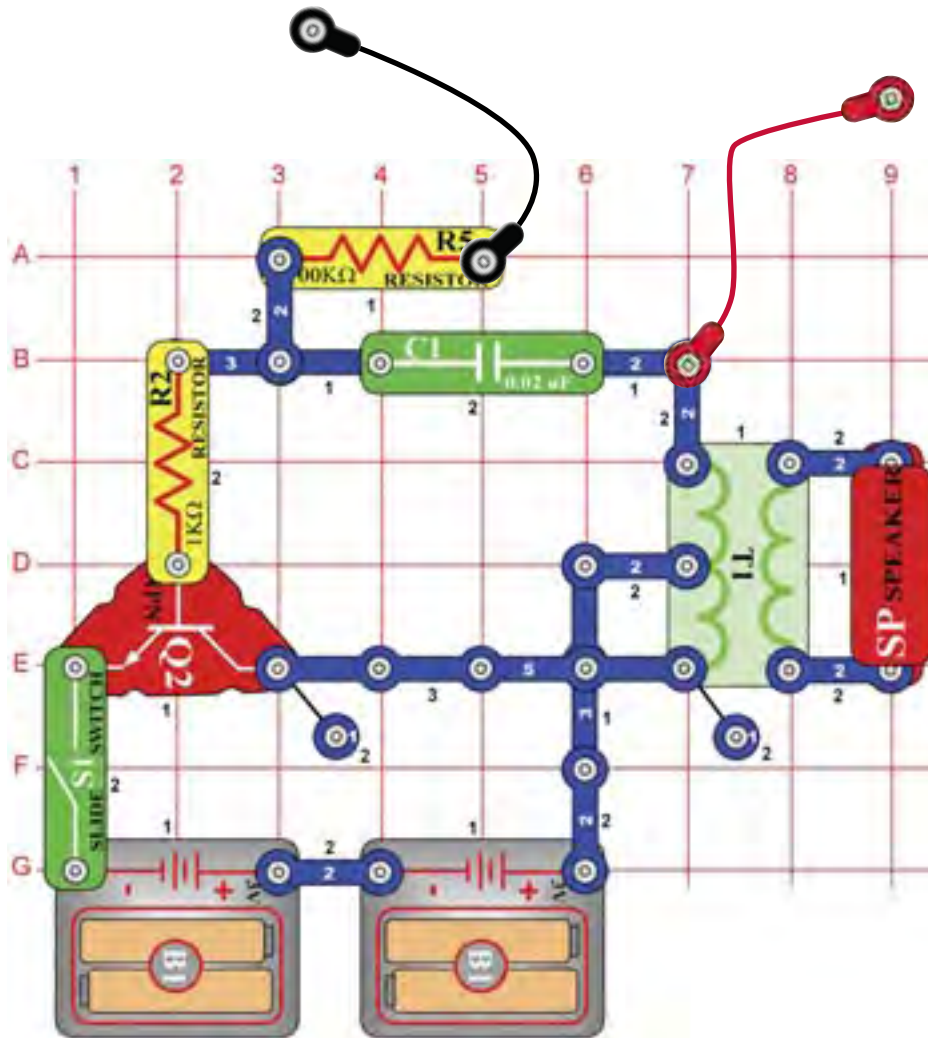

You need some more parts to do this experiment, so you're going to draw them. Take a pencil (No. 2 lead is best but other types will also work), **SHARPEN IT**, and fill in the 4 rectangles you see below. You will get better results if you **place a hard, flat surface between this page and the rest of this booklet** while you are drawing. **Press hard** (but don't rip the paper) and **fill in each several times** to be sure you have a **thick, even layer of pencil lead** and try to avoid going out of the boundaries.

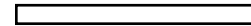

Shapes to be drawn.

Use a SHARP No. 2 pencil, draw on a hard surface, press hard and fill in several times for best results.

Actually, your pencils aren't made out of lead anymore (although we still call them "lead pencils"). The "lead" in your pencils is really a form of carbon, the same material that resistors are made of. So the drawings you just made should act just like the resistors in Snap Circuits®.

Build the circuit shown, it is the same basic oscillator circuit you have been using. Touch the the loose ends of the jumper wires to opposite ends of the rectangles you drew, you should hear a sound like an alarm. **Note:** You may get better electrical contact between the wires and the drawings if you wet the metal with a few drops of water or saliva.

Making the drawn resistors longer should increase the resistance while making them wider should reduce the resistance. So all 4 rectangles should produce the same sound, though you will see variations due to how thick and evenly you filled in the rectangles, and exactly where you touch the wires. If your 4 shapes don't sound similar then try improving your drawings.

Be sure to wash your hands after this project.



Project #517

Electronic Kazoo

Use the same circuit as project #516, but draw a new shape. A Kazoo is a musical instrument that is like a one-note flute, and you change the pitch (frequency) of the sound by moving a plunger up and down inside a tube.

As before, take a pencil (No. 2 lead is best but other types will also work), **SHARPEN IT** again, and fill in the shape you see below. For best results, **SHARPEN IT again, place a hard flat surface between this page and the rest of this booklet while you are drawing. Press hard (but don't rip the paper). Fill in each several times** to be sure you have a **thick, even layer of pencil lead**, and try to avoid going out of the boundaries. **Where the shape is just a line, draw a thick line and go**

over it several times. The black ink in this manual is an insulator just like paper, so you have to write over it with your pencil.

Take one loose wire and touch it to the widest part of this shape, at the upper left. Take the other loose wire and touch it just to the right of the first wire. You should hear a high-pitch sound. How do you think the sound will change as you slide the second wire to the right? Do it, slowly sliding all the way around to the end. The sound changes from high frequency to low frequency, just like a kazoo. **Note:** You may get better electrical contact between the wires and the drawings if you wet the wires with a few drops of water or saliva.

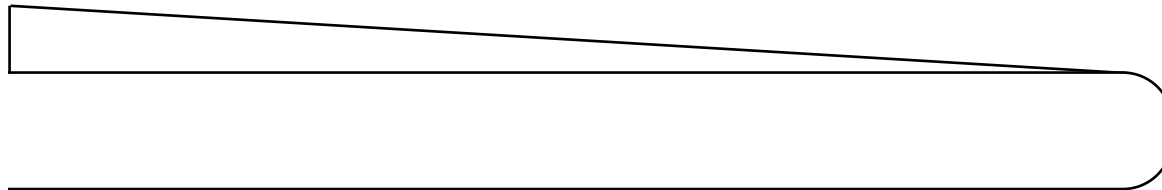

Shape to be drawn.

Use a SHARP No. 2 pencil, draw on a hard surface, press hard and fill in several times for best results.



Project #518

Electronic Kazoo (II)

Use the same circuit as project #516, but fill in the new shape shown here.

Take one loose jumper wire and touch it to the left circle. Take the other loose wire and touch it to each of the other circles. The various circles produce different pitches in the sound, like notes. Since the circles are like keys on a piano, you now have an electronic keyboard! See what kind of music you can play with it. **Note:** You may get better electrical contact between the wires and the drawings if you wet the wires with a few drops of water or saliva.

Now take one loose wire and touch it to the right circle (#11). Take the other wire and touch it to the circles next to the numbers shown below, in order:

- 7 - 5 - 1 - 5 - 7 - 7 - 7
- 5 - 5 - 5
- 7 - 7 - 7
- 7 - 5 - 1 - 5 - 7 - 7 - 7 - 7 - 5 - 5 - 7 - 5 - 1

Do you recognize this nursery rhyme? It is "Mary Had a Little Lamb". By now you see that you can draw any shape you like and make electronic sounds with it. Experiment on your own as much as you like. Be sure to wash your hands after this test.

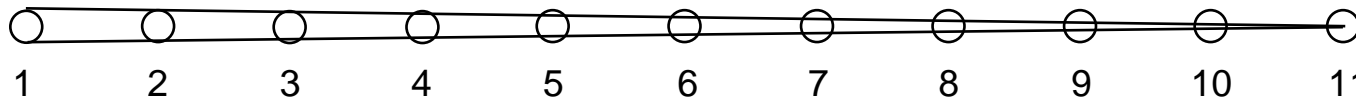

Shape to be drawn.

Use a SHARP No. 2 pencil, draw on a hard surface, press hard and fill in several times for best results.

Project #519 Water Resistor

OBJECTIVE: *To use water as a resistor.*



Use the same circuit as project #516. Take the two loose jumper wires and touch them with your fingers. You should hear a low-frequency sound. Now place the loose jumpers in a cup of water without them touching each other. The sound will have a much higher frequency because drinking water has lower resistance than your body. You can change the sound by adding or removing water from the cup. If you add salt to the water then you will notice the frequency increase, because dissolving salt lowers the resistance of the water.

You can also make a water kazoo. Pour a small amount of water on a table or the floor and spread it with your finger into a long line. Place one of the jumper wires at one end and slide the other along the water. You should get an effect just like the kazoo you drew with the pencil, though the frequency will probably be different.

Project #520

Two-Transistor Oscillator

OBJECTIVE: *To make an adjustable low-frequency oscillator.*

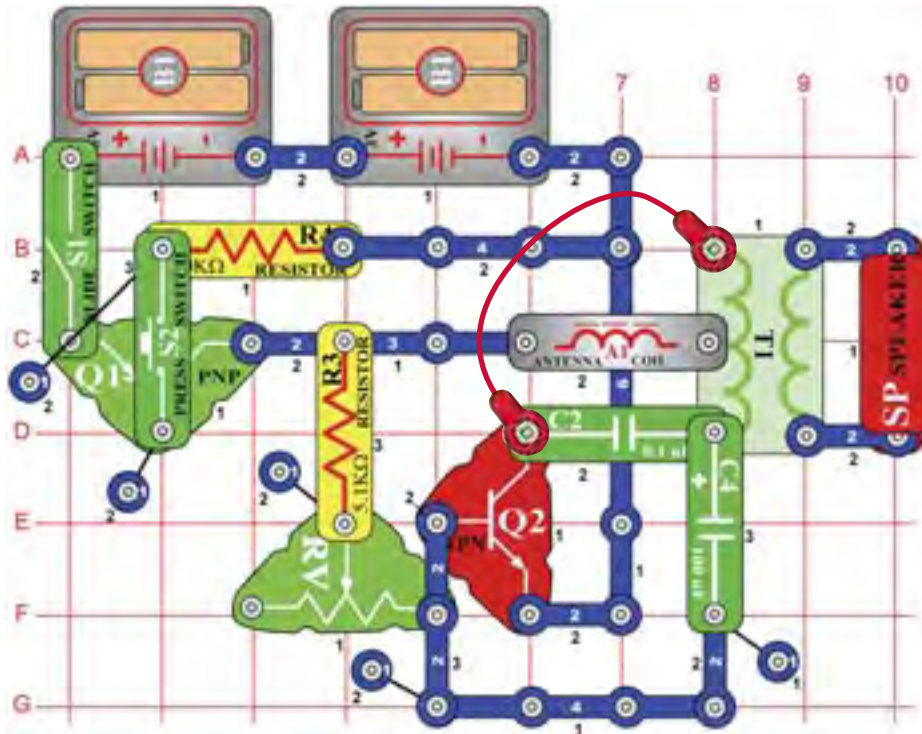

Build the circuit, turn on the slide switch (S1), and then press the push switch (S2). Move the control lever of the adjustable resistor (RV) to change the frequency.

Project #521

Diode

OBJECTIVE: *To show how a diode works.*

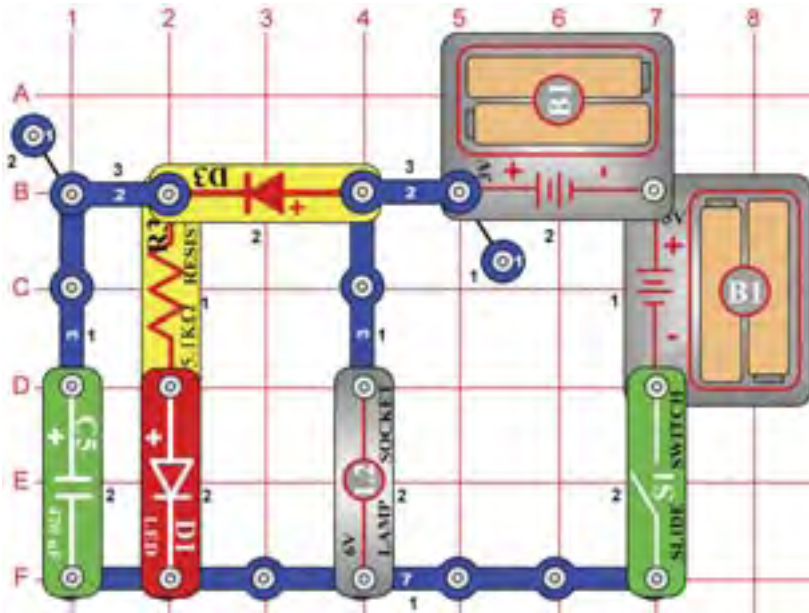

Turn on the slide switch (S1), the lamp (L2) will be bright and the LED (D1) will be lit. The diode (D3) allows the batteries to charge up the 470µF capacitor (C5) and light the LED.

Turn off the slide switch, the lamp will go dark immediately but the LED will stay lit for a few seconds as capacitor C5 discharges through it. The diode isolates the capacitor from the lamp; if you replace the diode with a 3-snap wire then the lamp will drain the capacitor almost instantly.

Project #522

Rectifier

OBJECTIVE: *To build a rectifier.*

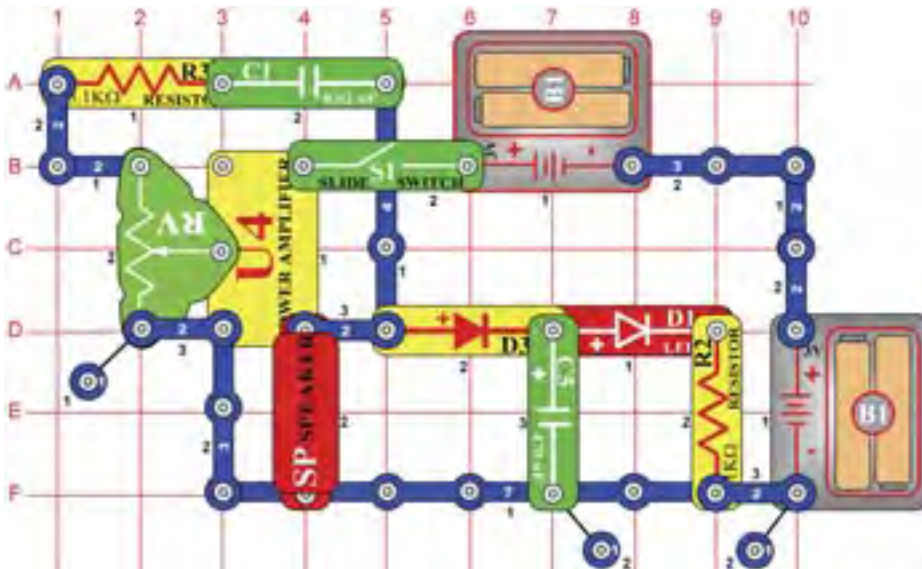

This circuit is based on the Trombone project #238. Turn on the slide switch (S1) and set the adjustable resistor (RV) for mid-range for the best sound. The LED (D1) will also be lit.

The signal from the power amplifier (U4) to the speaker (SP) is a changing (AC) voltage, not the constant (DC) voltage needed to light the LED. The diode (D3) and capacitor (C5) are a rectifier, which converts the AC voltage into a DC voltage.

The diode allows the capacitor to charge up when the power amp voltage is high, but also prevents the capacitor from discharging when the power amp voltage is low. If you replace the diode with a 3-snap or remove the capacitor from the circuit, the LED will not light.

Project #523

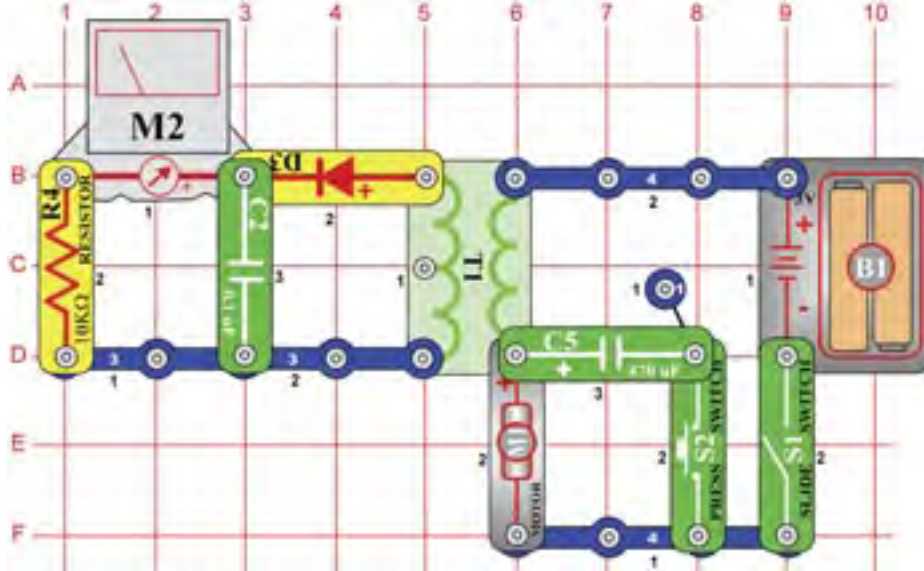

Motor Rectifier

OBJECTIVE: To show how what a rectifier does.

Set the meter (M2) to the LOW (or 10mA) scale. Place the fan on the motor (M1) and turn on the slide switch (S1), the meter measures the current on the other side of the transformer (T1).

As the DC voltage from the battery (B1) spins the motor, the motor creates an AC ripple in the voltage. This ripple passes through the transformer using magnetism. The diode and 0.1µF capacitor (C2) "rectify" the AC ripple into the DC current that the meter measures.

Holding down the press switch (S2) connects the 470µF capacitor (C5) across the motor. This filters out the AC ripple, so the current through the meter is greatly reduced but the motor speed is not affected.



WARNING: Moving parts. Do not touch the fan or motor during operation.

Project #524

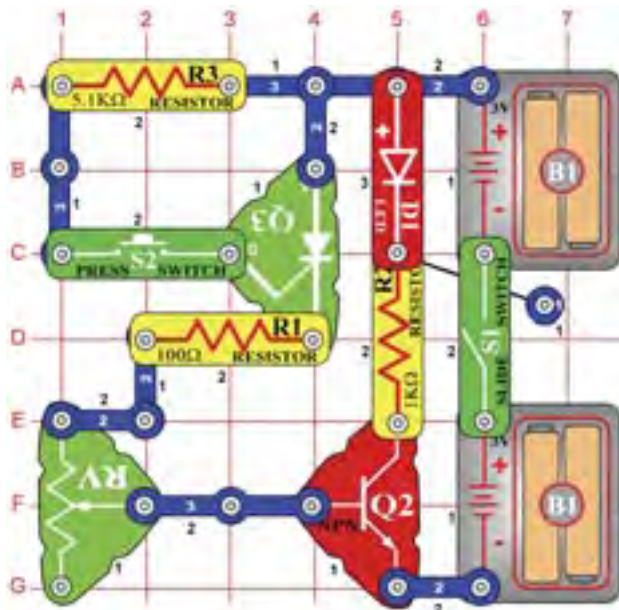

SCR Shutdown

OBJECTIVE: To show how an SCR works.

In this circuit the press switch (S2) controls an SCR (Q3), which controls a transistor (Q2), which controls an LED (D1). Set the adjustable resistor (RV) control lever to the top (toward the press switch).

Turn on the slide switch (S1); nothing happens. Press and release the press switch; the SCR, transistor, and LED turn on and stay on. Now move the adjustable resistor control down until the LED turns off. Press and release the press switch again; this time the LED comes on but goes off after you release the press switch.

If the current through an SCR (anode-to-cathode) is above a threshold level, then the SCR stays on. In this circuit you can set the adjustable resistor so that the SCR (and the LED it controls) just barely stays on or shuts off.

Project #525

SCR Motor Control

OBJECTIVE: To show how an SCR is used.



SCR's are often used to control the speed of a motor. The voltage to the gate would be a stream of pulses, and the pulses are made wider to increase the motor speed.

Place the fan on the motor (M1) and turn on the slide switch (S1). The motor spins and the lamp (L2) lights. Wave your hand over the photoresistor (RP) to control how much light shines on it, this will adjust the speed of the motor. By moving your hand in a repetitive motion, you should be able spin the motor at a slow and steady speed.

WARNING: Moving parts. Do not touch the fan or motor during operation.

Project #526

Output Forms

OBJECTIVE: To show the different types of output from Snap Circuits®.

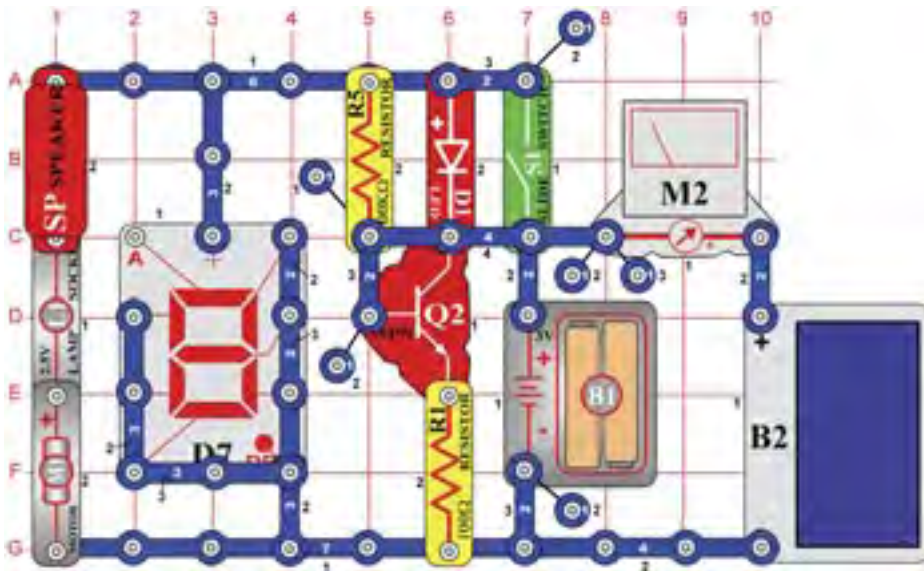

Set the meter (M2) to the LOW (or 10mA) scale. This circuit uses all six forms of output available in Snap Circuits® - speaker (SP, sound), lamp (L1, light), LED (D1, light), motor (M1, motion), 7-segment display (D7, light), and meter (M2, motion of pointer).

Place the fan on the motor, turn on the slide switch (S1), and shine light on the solar cell (B2). There will be activity from all six forms of output. If the motor does not spin, then give it a push with your finger to start it, or remove the fan.

WARNING: Moving parts. Do not touch the fan or motor during operation.

Project #527

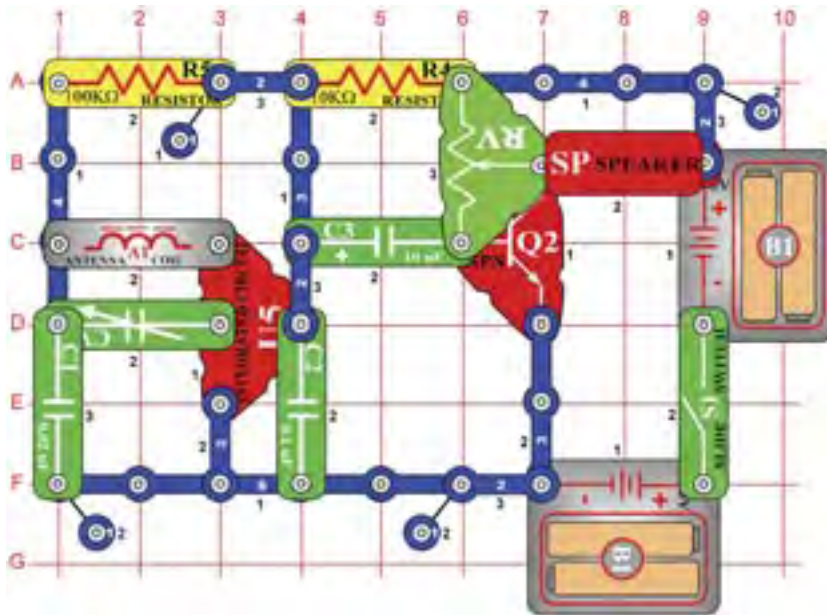

Transistor AM Radio

OBJECTIVE: To show the output of an AM radio.

This AM radio circuit uses a transistor (Q2) in the amplifier that drives the speaker (SP). Turn on the slide switch (S1) and adjust the variable capacitor (CV) for a radio station, then adjust the loudness using the adjustable resistor (RV).

Project #528

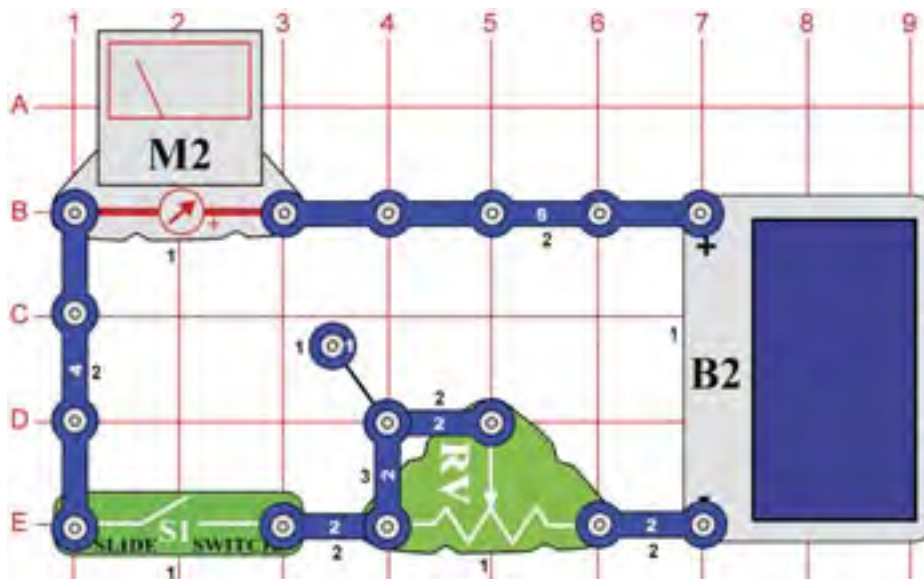

Adjustable Solar Power Meter

OBJECTIVE: To learn about solar power.

Set the adjustable resistor (RV) for mid-range and the meter (M2) for the LOW (or 10mA) setting. Turn on the slide switch (S1) and let light shine on the solar cell (B2). Move the solar cell around different light sources and adjust the adjustable resistor to change the reading on the meter.

Place your hand to cover half of the solar cell, the meter reading should drop by half. When you reduce the light to the solar cell, the current in the circuit is reduced.

Place a sheet of paper over the solar cell and see how much it changes the reading on the meter. Then add more sheets until the meter reads zero.

Project #529

Fan Blade Storing Energy

OBJECTIVE: To show that the fan blade stores energy.

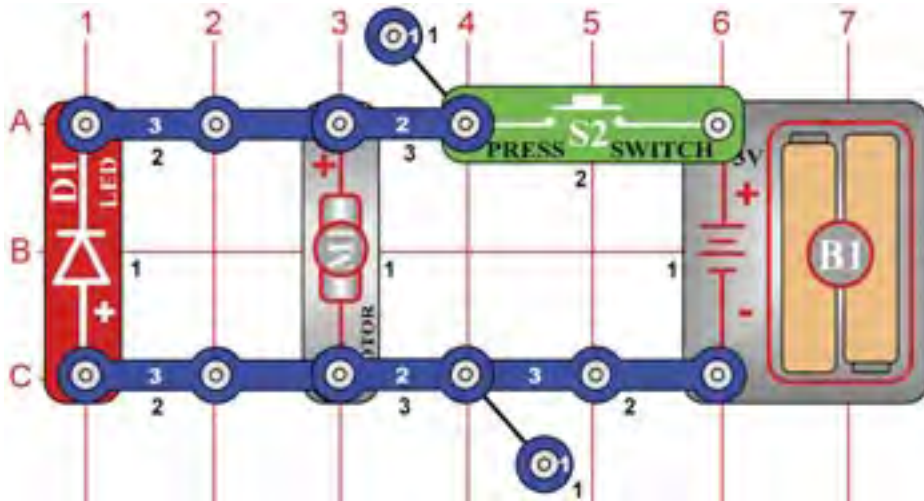

Place the fan on the motor (M1). Hold down the press switch (S2) for a few seconds and then watch the LED (D1) as you release the press switch. The LED lights briefly but only after the batteries (B1) are disconnected from the circuit.

Do you know why the LED lights? It lights because the mechanical energy stored in the fan blade makes the motor act like a generator. When the press switch is released, this energy creates a brief current through the LED. If you remove the fan blade from the circuit then the LED will never light, because the motor shaft alone does not store enough mechanical energy.

If you reverse the motor direction, then the LED will light the same way, but the fan may fly off after the LED lights.



WARNING: Moving parts. Do not touch the fan or motor during operation.

This circuit was suggested by Mike D. of Woodhaven, NY.

Project #530 Antenna Storing Energy

OBJECTIVE: To show that the antenna stores energy.

Modify project #529 by replacing the motor (M1) with the antenna coil (A1). Hold down the press switch (S2) and then watch the LED (D1) as you release the press switch. The LED lights briefly but only after the batteries (B2) are disconnected from the circuit.

This circuit is different from the Fan Blade Storing Energy project because energy in the antenna coil is stored in a magnetic field. When the press switch is released, this field creates a brief current through the LED.

Note that the energy stored in a magnetic field acts like mechanical momentum, unlike capacitors which store energy as an electrical charge across a material. You can replace the antenna with any of the capacitors but the LED will not light. Energy stored in the magnetic fields of coils was called electrical momentum in the early days of electronics.

Project #531

Electromagnet Storing Energy

OBJECTIVE: To show that the electromagnet stores energy.

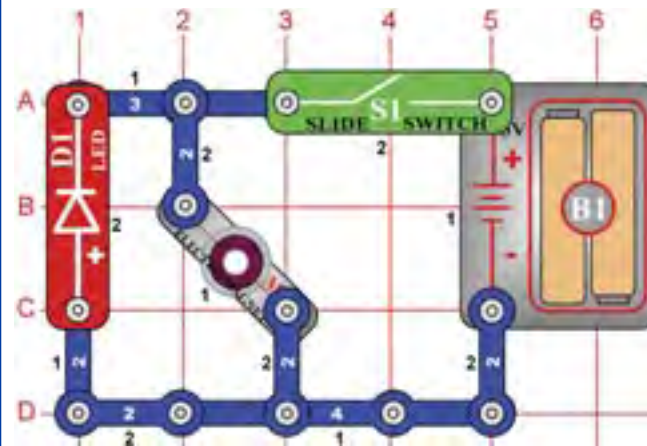

Turn on the slide switch (S1); nothing happens. Turn the switch off; the LED (D1) flashes.

When you turn on the switch, the electromagnet (M3) stores energy from the batteries (B1) into a magnetic field. When you turn off the switch, the magnetic field collapses and the energy from it discharges through the LED.

Project #532

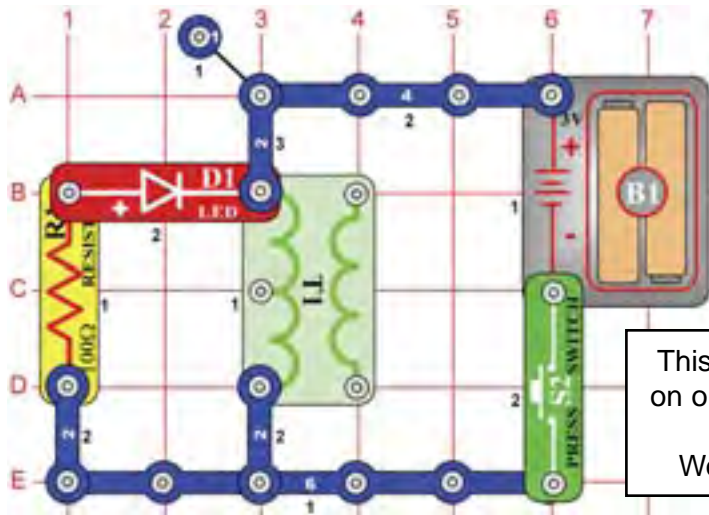

This circuit is based on one suggested by Mike D. of Woodhaven, NY.

Transformer Storing Energy

OBJECTIVE: To show that the transformer stores electrical energy.

Hold down the press switch (S2) and then watch the LED (D1) as you release the press switch. The LED lights briefly but only after the batteries (B1) are disconnected from the circuit.

This circuit is similar to the Antenna Storing Energy project, and shows how the coils in the transformer (T1) also store energy in magnetic fields. When the press switch is released, this energy creates a brief current through the LED.

Project #533 Relay Storing Energy

OBJECTIVE: To show that the relay stores energy.

Modify project #532 by replacing the transformer (T1) with the relay (S3), position it with the 3-snap sides to top and right (as in project #341).

Hold down the press switch (S2) and then watch the LED (D1) as you release the press switch. The LED lights briefly but only after the batteries (B1) are disconnected from the circuit.

The relay has a coil similar to the one in the transformer, and stores energy in the same way.

Project #534 Transformer Lights

OBJECTIVE: To show how the transformer works.

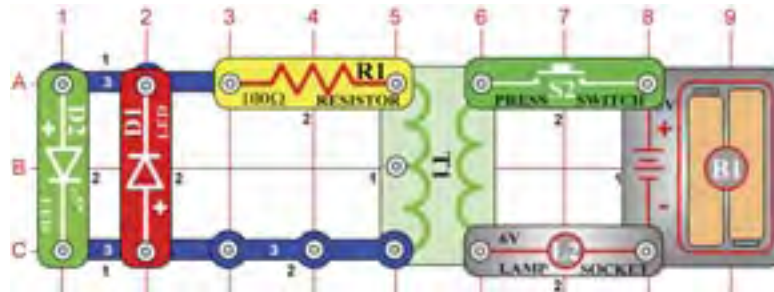

Watch the LED's (D1 & D2) as you press or release the press switch (S2). The red LED (D1) lights briefly just as you press the press switch and the green LED (D2) lights briefly just after you release it, but neither lights while you hold the press switch down. Why?

When you press the press switch, a surge of current from the battery charges a magnetic field in the transformer (T1), which stays constant as the press switch is held down. Charging the magnetic field induces an opposing current on the other side of the transformer, which lights the red LED until the

magnetic fields stabilize.

When you release the press switch (removing the current from the battery), the magnetic field discharges. Initially the transformer tries to maintain the magnetic field by inducing a current on the other side, which lights the green LED until the resistor (R1) absorbs the remaining energy.

Note that this project is different from the Antenna Storing Energy project because there is a magnetic connection across the transformer, not an electrical connection.

Project #535

Machine Siren

OBJECTIVE: To see how the electromagnet can change the sound from the alarm IC.

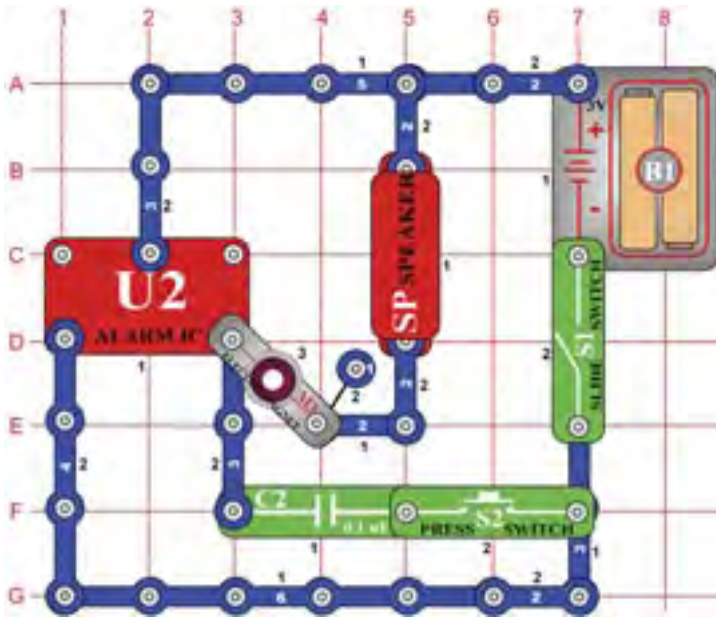

Turn on the slide switch (S1), you hear a strange sound from the speaker (SP). Push the press switch (S2) and the sound changes to a high-pitch siren.

The alarm IC (U2) produces a smooth siren sound, but the electromagnet (M3) distorts the siren into the strange sound you hear. Adding the 0.1µF capacitor (C2) counters the electromagnet effects and restores the siren.

Project #536

Hear the Motor

OBJECTIVE: To show how a motor works.

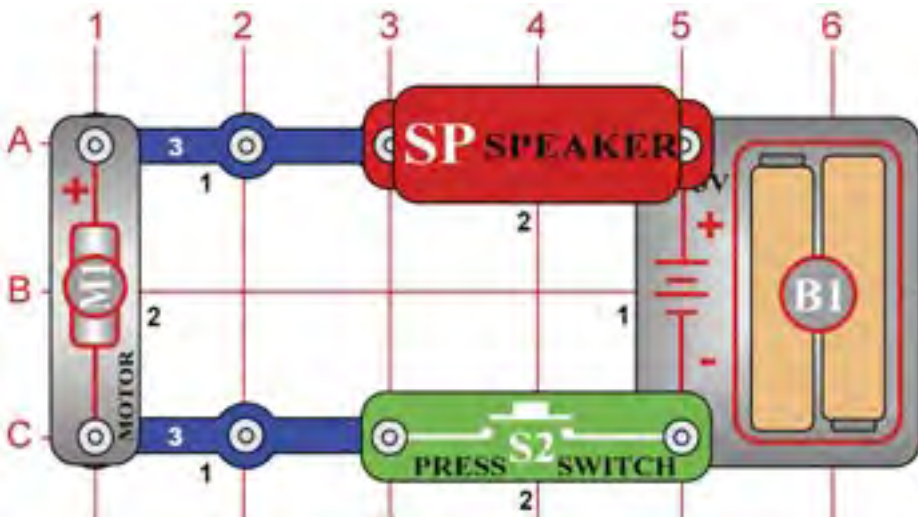

Place the fan on the motor (M1). Press the press switch (S2) and listen to the motor. Why does the motor make sound?

A motor uses magnetism to convert electrical energy into mechanical spinning motion. As the motor shaft spins around it connects/disconnects several sets of electrical contacts to give the best magnetic properties. As these contacts are switched, an electrical disturbance is created, which the speaker converts into sound.

WARNING: Moving parts. Do not touch the fan or motor during operation.

This circuit was suggested by Andrew M. of Cochrane, Alberta, Canada

Project #537

Back EMF

OBJECTIVE: To demonstrate how the motor works.

WARNING: Moving parts. Do not touch the fan or motor during operation.

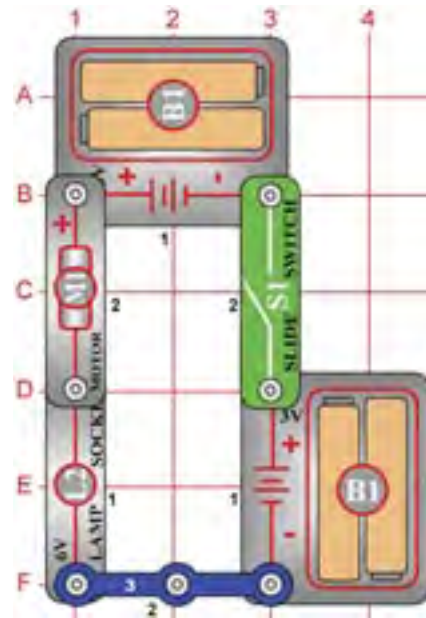

The voltage produced by a motor when it is spinning is called its *Back Electro-Motive-Force* (Back EMF); this may be thought of as the motor's electrical resistance. The motor's *Front Electro-Motive-Force* is the force it exerts in trying to spin the shaft. This circuit demonstrates how the Back EMF increases and the current decreases as the motor speeds up.

Place the fan on the motor (M1) and turn on the slide switch (S1). The 6V bulb (L2) will be bright, indicating that the Back EMF is low and the current is high.

Turn off the slide switch, remove the fan, and turn the slide switch back on. The lamp is bright when the motor starts and the lamp dims as the motor speeds up. Now the Back EMF is high and the current is low. BE CAREFUL NOT TO TOUCH THE MOTOR WHILE IT SPINS.

Project #538

Back EMF (II)

OBJECTIVE: To demonstrate how the motor draws more current to exert greater force when spinning slowly.

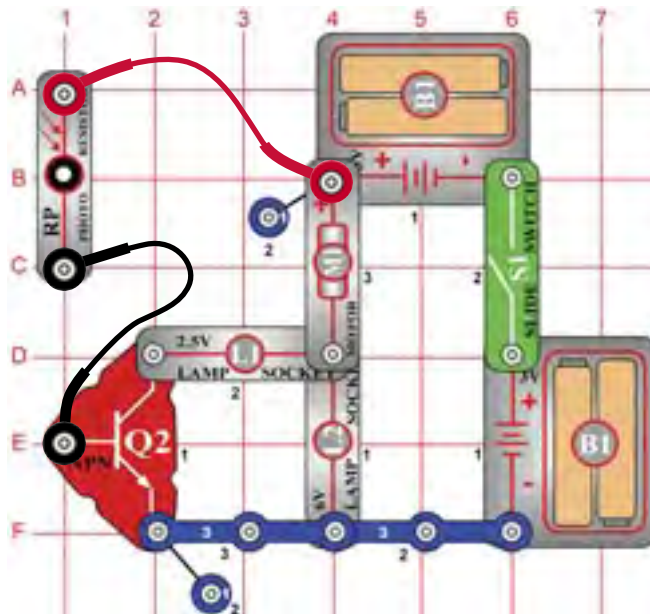

Place the fan on the motor (M1). Connect the photoresistor (RP) with the jumper wires as shown, and hold it next to the 6V lamp (L2) so the light shines on it.

Turn on the slide switch (S1) and watch how the 6V lamp is bright at first, but gets dim as the motor speeds up. By moving the photoresistor (RP) next to or away from the 6V lamp, you should be able to change the motor speed. To slow the motor down even more, cover the photoresistor.

When the photoresistor is held next to the 6V lamp, transistor Q2 (with lamp L1) will try to keep the motor at a constant speed.

WARNING: Moving parts. Do not touch the fan or motor during operation.

Project #539

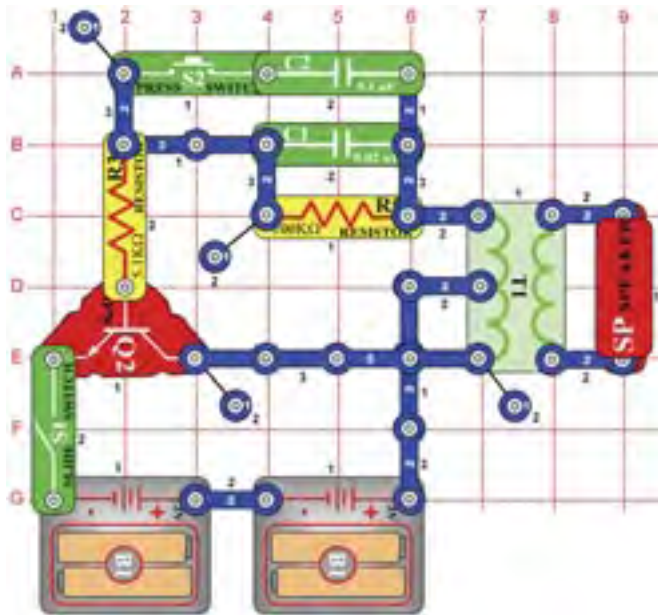

Electronic Sound

OBJECTIVE: *To make different tones with an oscillator.*

Build the circuit and turn on the slide switch (S1), you hear a high-frequency tone. Press the press switch (S2) to lower the frequency by increasing the capacitance in the oscillator. Replace the 0.1μF capacitor (C2) with the 10μF capacitor (C3, "+" on the right) to further lower the frequency of the tone.

Project #540 Electronic Sound (II)

OBJECTIVE: *To make different tones with an oscillator.*

You can also change the frequency by changing the resistance in the oscillator. Replace the 100KΩ resistor (R5) with the 10KΩ resistor (R4), place the 0.1μF capacitor (C2) back in the circuit as before.

Project #541

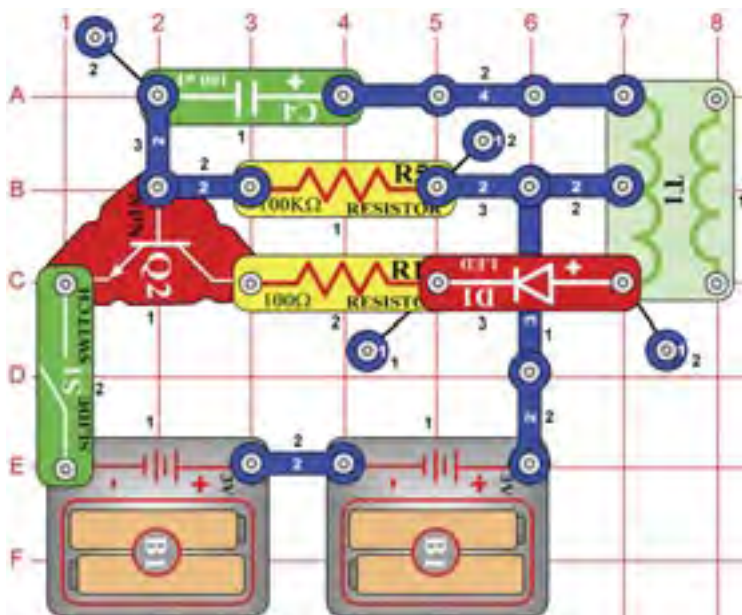

Lighthouse

OBJECTIVE: *To make a blinking light.*

Build the circuit and turn on the slide switch (S1), the LED (D1) flashes about once a second.

Project #542

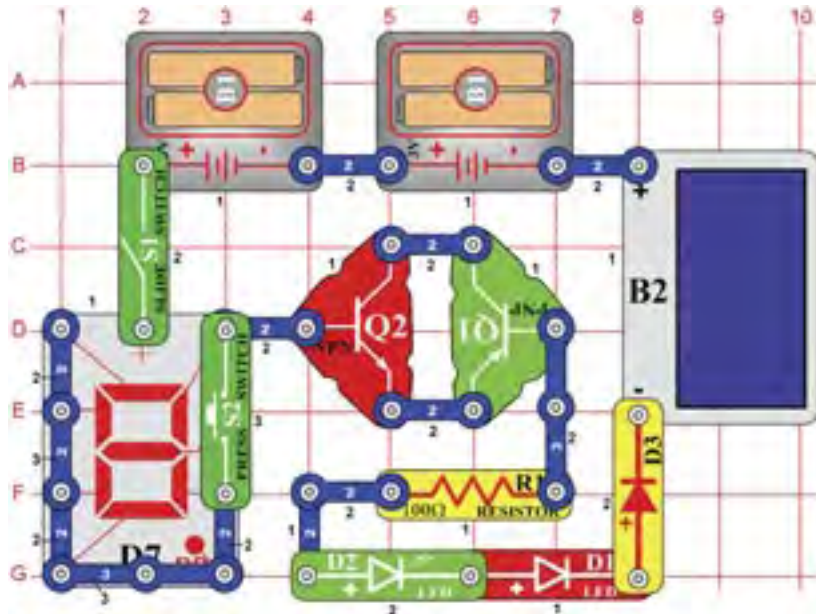

Diode Wonderland

OBJECTIVE: *To learn more about diodes.*

Cover the solar cell (B2) and turn on the slide switch (S1), there should be little or no light from the LED's (results depend on your batteries). Shine a bright light on the solar cell and the red (D1) and green (D2) LED's should be bright, along with one segment of the 7-segment display (D7).

This circuit shows how it takes a lot of voltage to turn on a bunch of diodes connected in a series. Since the transistors (Q1 & Q2) are used as diodes here, there are six diodes total (D1, D2, D3, D7, Q1, and Q2). The voltage from the batteries (B1) alone is not enough to turn them all on at the same time, but the extra voltage produced by the solar cell is enough to make them bright.

Now push the press switch (S2) and D7 will display "0.", but it will be dim unless the light on the solar cell is very bright. With S2 off, all the current through D7 goes through segment B and makes it bright. With S2 on, the current through D7 divides evenly between several segments.

Project #543

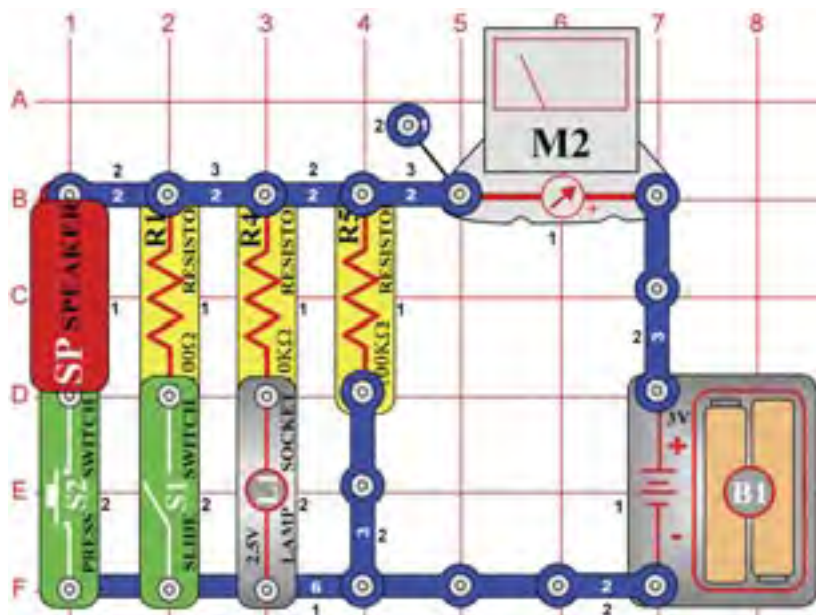

Meter Ranges

OBJECTIVE: *To show the difference between the low and high current meter ranges.*

Use the LOW (or 10mA) setting on the meter (M2), turn off the slide switch (S1), and unscrew the 2.5V bulb (L1). The meter should measure about 2, since the 100KΩ resistor (R5) keeps the current low. Results will vary depending on how good your batteries are.

Screw in the 2.5V bulb to add the 10KΩ resistor (R4) to the circuit, now the meter reading will be about 10.

Change the meter to the high-current HIGH (or 1A) setting. Now turn on the slide switch to add the 100Ω resistor to the circuit. The meter should read just above zero.

Now press the switch (S2) to add the speaker (SP) to the circuit. The meter reading will be about 5, since the speaker has only about 8Ω resistance.

Project #544

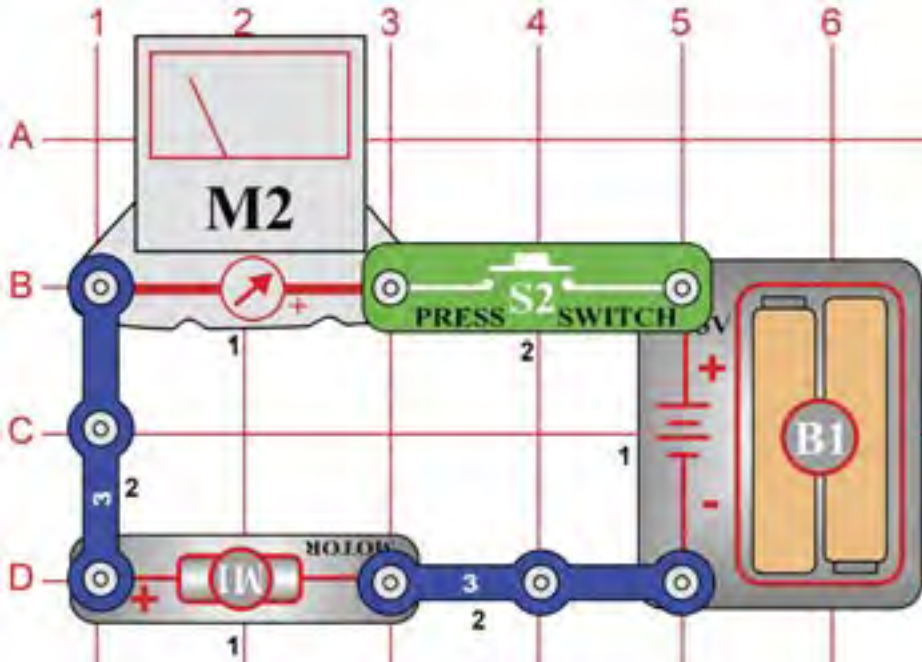

WARNING: Moving parts. Do not touch the fan or motor during operation.

Motor Current

OBJECTIVE: To measure the motor current.

Use the HIGH (or 1A) setting on the meter (M2) and place the fan on the motor (M1). Press the press switch (S2), the meter will measure a very high current because it takes a lot of power to spin the fan.

Remove the fan and press the press switch again. The meter reading will be lower since spinning the motor without the fan takes less power.

Project #545 2.5V Lamp Current

OBJECTIVE: To measure the 2.5V lamp current.

Use the circuit from project #544, but replace the motor with the 2.5V lamp (L1). Measure the current using the HIGH (or 1A) setting on the meter.

Project #546 6V Lamp Current

OBJECTIVE: To measure the 6V lamp current.

Use the circuit from project #544 but replace the motor with the 6V lamp (L2). Measure the current using the HIGH (or 1A) setting on the meter (M2). Compare the lamp brightness and meter reading to that for the 2.5V lamp (L1).

Project #547

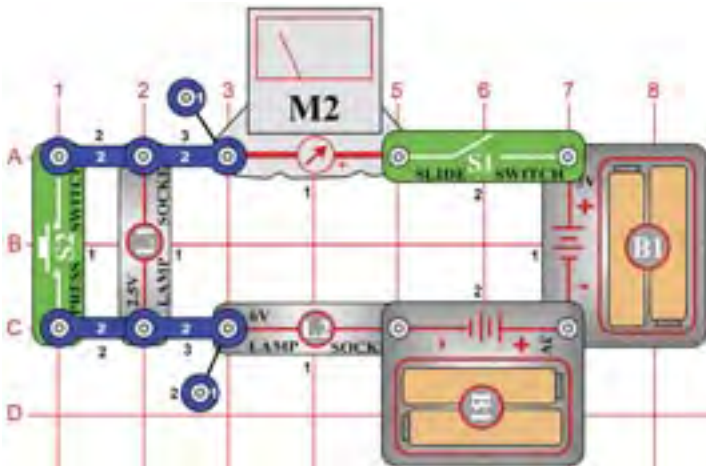

Combined Lamp Circuits

OBJECTIVE: To measure current through the lamps.

Use the HIGH (or 1A) setting on the meter (M2) and turn on the slide switch (S1). Both lamps are on and the meter measures the current.

Now turn on the press switch (S2) to bypass the 2.5V lamp (L1). The 6V lamp (L2) is brighter now, and the meter measures a higher current.

Project #548

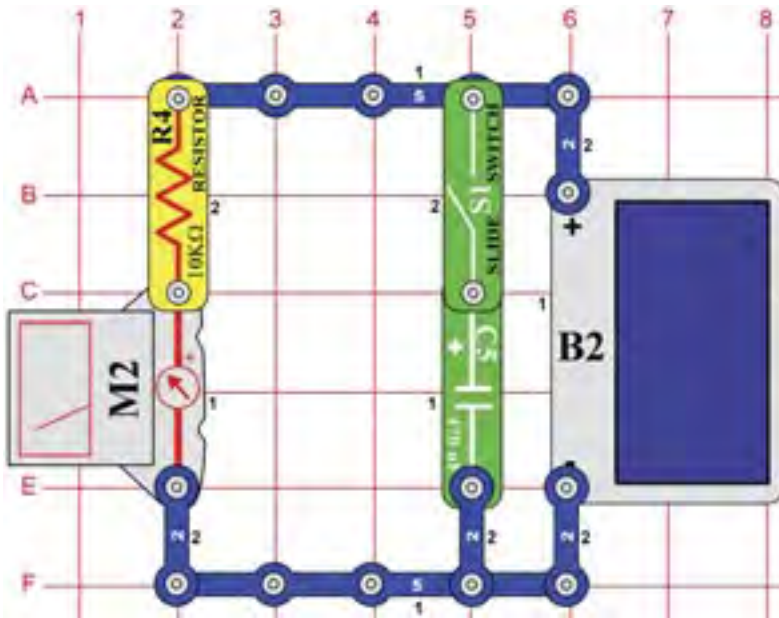

Rechargeable Battery

OBJECTIVE: To show how a capacitor is like a rechargeable battery.

Use the LOW (or 10mA) scale on the meter (M2) and turn the slide switch (S1) off. Vary the current measured on the meter by moving your hand over the solar cell (B2) to block some of the light to it. If you cover the solar cell, then the current immediately drops to zero.

Now turn the slide switch on and watch the meter again as you move your hand over the solar cell. Now the meter current drops slowly if you block the light to the solar cell. The 470µF capacitor (C5) is acting like a rechargeable battery. It keeps a current flowing to the meter when something (such as clouds) blocks light to the solar cell that is powering the circuit.

Project #549

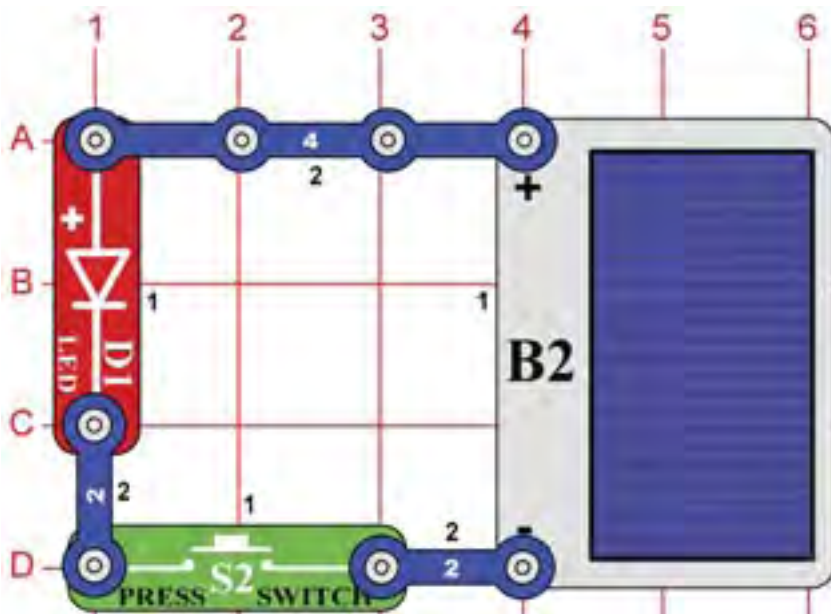

Solar Batteries

OBJECTIVE: To learn about solar power.

Place this circuit near different types of lights and press the press switch (S2). If the light is bright enough, then the LED (D1) will be lit. Find out what types of light sources make it the brightest.

Solar cells work best with bright sunlight, but incandescent light bulbs (used in house lamps) also work well. Fluorescent lights (the overhead lights in offices and schools) do not work as well with solar cells. Although the voltage produced by your solar cell is 3V just like the batteries, it cannot supply nearly as much current. If you replace the LED with the 2.5V lamp (L1) then it will not light, because the lamp needs a much higher current.

The solar cell (B2) is made from silicon crystals. It uses the energy in sunlight to make an electric current. Solar cells produce electricity that will last as long as the sun is bright. They are pollution-free and never wear out.

Project #550

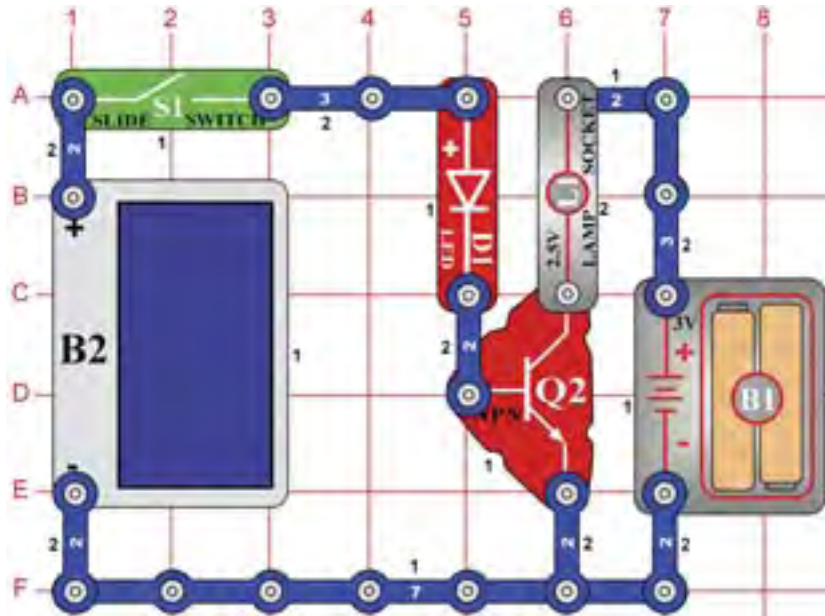

Solar Control

OBJECTIVE: *To learn about solar power.*

Build the circuit and turn on the slide switch (S1). If there is sunlight on the solar cell (B2), then the LED (D1) and lamp (L1) will be on.

This circuit uses the solar cell to light the LED and to control the lamp. The solar cell does not produce enough power to run the lamp directly. You can replace the lamp with the motor (M1, "+" side on top) and fan; the motor will spin if there is sunlight on the solar cell.

WARNING: Moving parts. Do not touch the fan or motor during operation.

Project #551

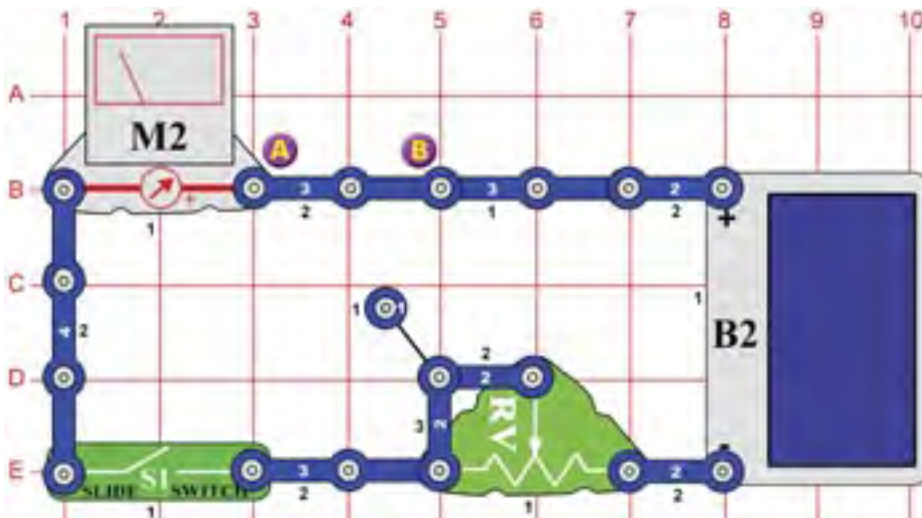

Solar Resistance Meter

OBJECTIVE: *To test the resistance of your components.*

Place the circuit near a bright light and set the adjustable resistor (RV) so that the meter (M2) reads "10" on the LOW (or 10mA) setting. Now replace the 3-snap between points A & B with another component to test, such as a resistor, capacitor, motor, photoresistor, or lamp. The 100 μ F (C4) or 470 μ F (C5) capacitors will give a high reading that slowly drops to zero.

You can also use the two-spring socket (?1) and place your own components between its springs to test them.

Project #552 Solar Diode Tester

OBJECTIVE: *To learn about solar power.*

Use the same circuit to test the red and green LED's (D1 & D2), and the diode (D3). The diode will give a higher meter reading than the LED's, and all three will block current in one direction.

Project #553

Solar NPN Transistor Tester

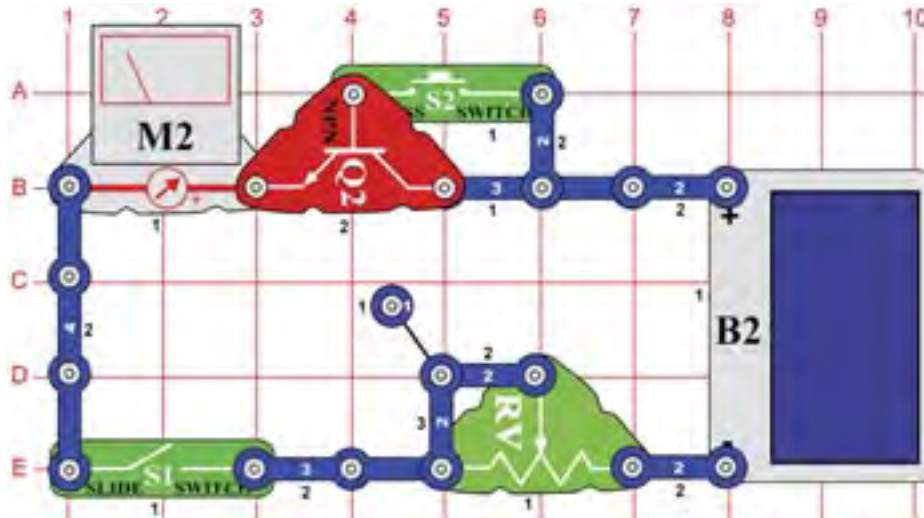

OBJECTIVE: To test your NPN transistor.

This circuit is just like the one in project #551, but tests the NPN transistor (Q2). The meter will read zero unless both switches (S1 & S2) are on, then the adjustable resistor (RV) sets the current. If you have the same light and RV setting as project #552 with the diode (D3), then the meter (M2) reading will be higher with the transistor.

You can replace the NPN transistor with the SCR (Q3), it works the same way in this circuit.

Project #554

Solar PNP Transistor Tester

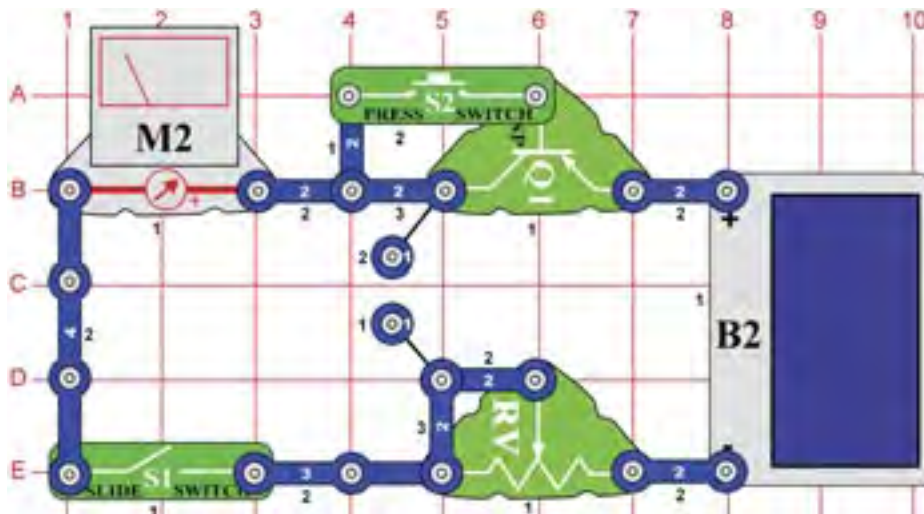

OBJECTIVE: To test your PNP transistor.

This circuit is just like the one in project #551, but tests the PNP transistor (Q1). The meter (M2) will read zero unless both switches (S1 & S2) are on, then the adjustable resistor (RV) sets the current. If you have the same light and RV setting as project #552 with the diode (D3), then the meter reading will be higher with the transistor.

Project #555

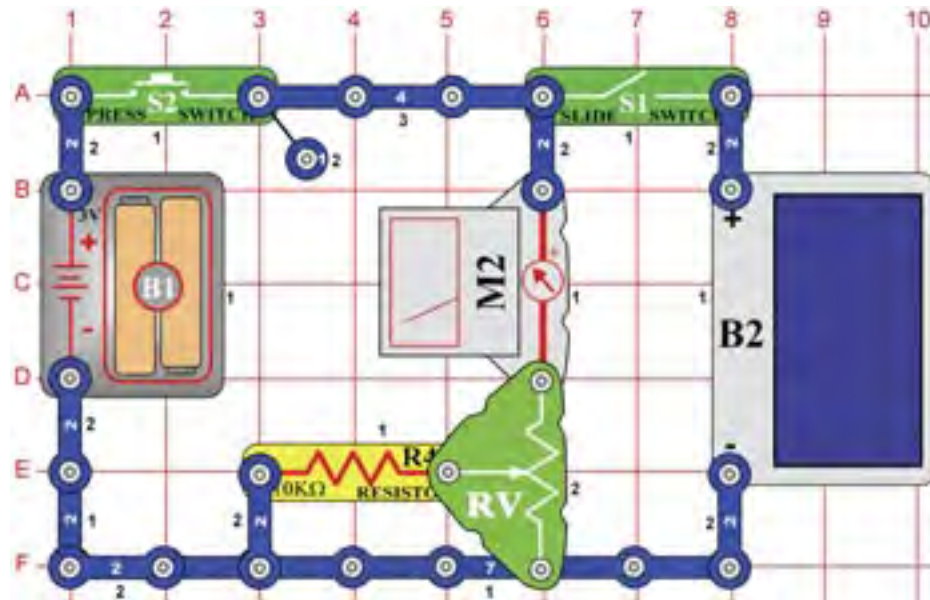

Solar Cell vs. Battery

OBJECTIVE: To compare the voltage of the solar cell to the battery.

Set the meter (M2) to the LOW (or 10mA) scale. Press the press switch (S2) and set the adjustable resistor (RV) so that the meter reads "5", then release it.

Now turn on the slide switch (S1) and vary the brightness of light to the solar cell (B2). Since the voltage from the batteries (B1) is 3V, if the meter reads higher than "5", then the solar cell voltage is greater than 3V. If the solar cell voltage is greater and you have rechargeable batteries (in B1), then turning on both switches at the same time will use the solar cell to recharge your batteries.

Project #556

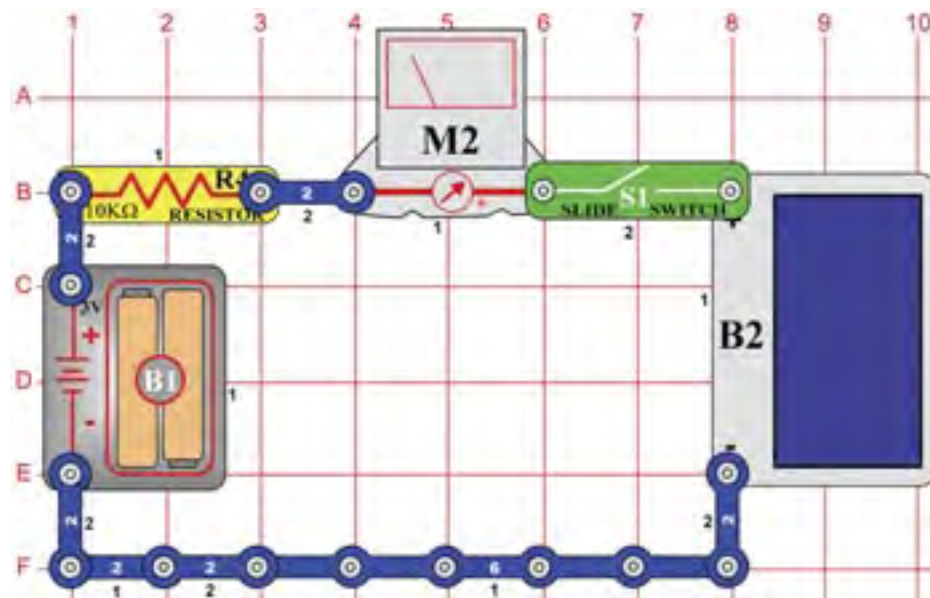

Solar Cell vs. Battery (II)

OBJECTIVE: To compare the voltage of the solar cell to the battery.

Set the meter (M2) to the LOW (or 10mA) scale. Turn on the slide switch (S1) and vary the brightness of light to the solar cell (B2). If the meter reads zero, then the battery voltage is higher than the voltage produced by the solar cell.

If the meter reads greater than zero, then the solar cell voltage is higher. If the batteries are rechargeable then the solar cell will recharge them until the voltages are equal.

Project #557

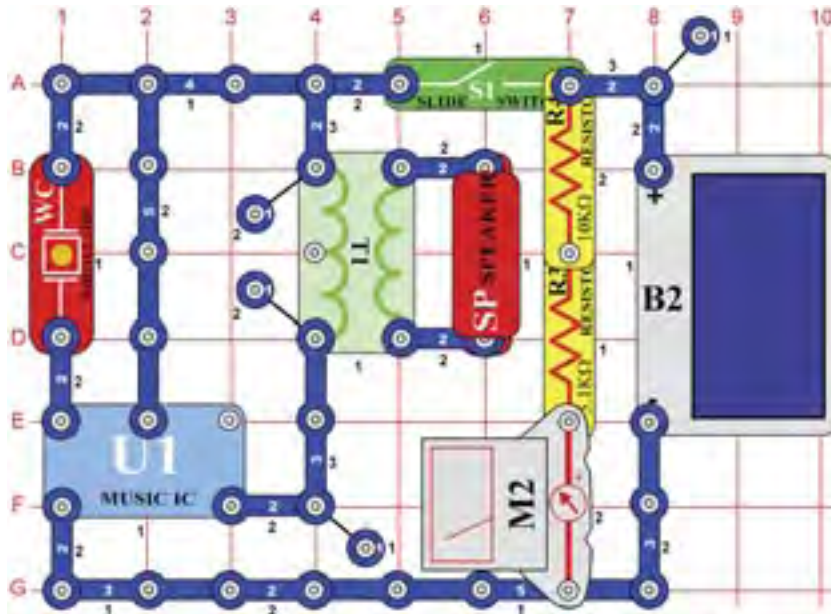

Solar Music

OBJECTIVE: *To use the sun to make music.*

Set the meter (M2) to the LOW (or 10mA) scale. With the slide switch (S1) off, make sure you have enough light on the solar cell (B2) for the meter to read 7 or higher. Now turn on the slide switch and listen to the music. When it stops, clap your hands and it should resume.

The meter is used to measure if the solar cell can supply enough current to operate the music IC (U1).

Project #558

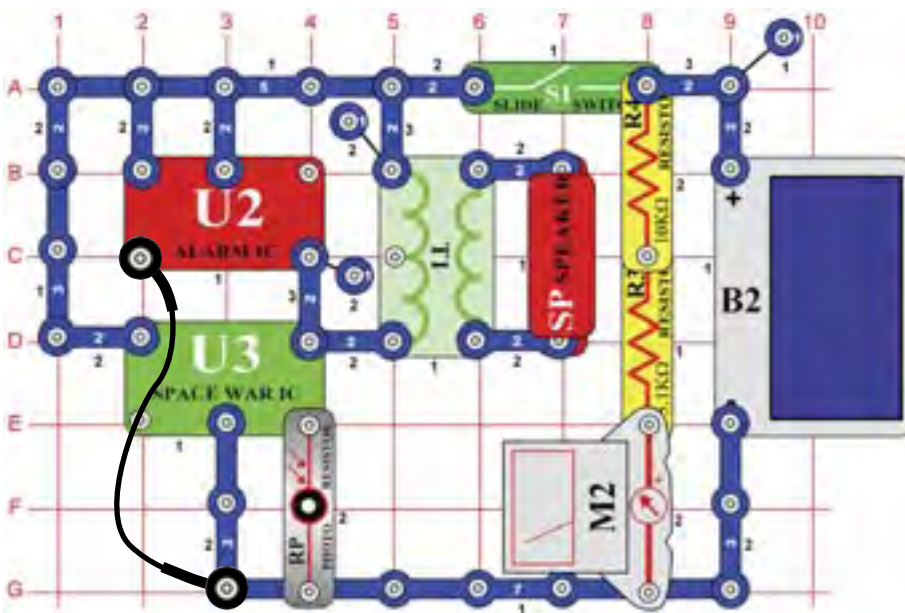

Solar Sounds Combo

OBJECTIVE: *To use the sun to make sounds.*

Set the meter (M2) to the LOW (or 10mA) scale. With the slide switch (S1) off, make sure you have enough light on the solar cell (B2) for the meter to read 9 or higher. Now turn on the slide switch and listen to sounds from the alarm (U2) and space war (U3) IC's. Wave your hand over the photoresistor (RP) to change the sounds.

The meter is used to measure if the solar cell can supply enough current to operate the alarm and space war IC's. This project needs more light than project #557, since two IC's are used here.

Project #559

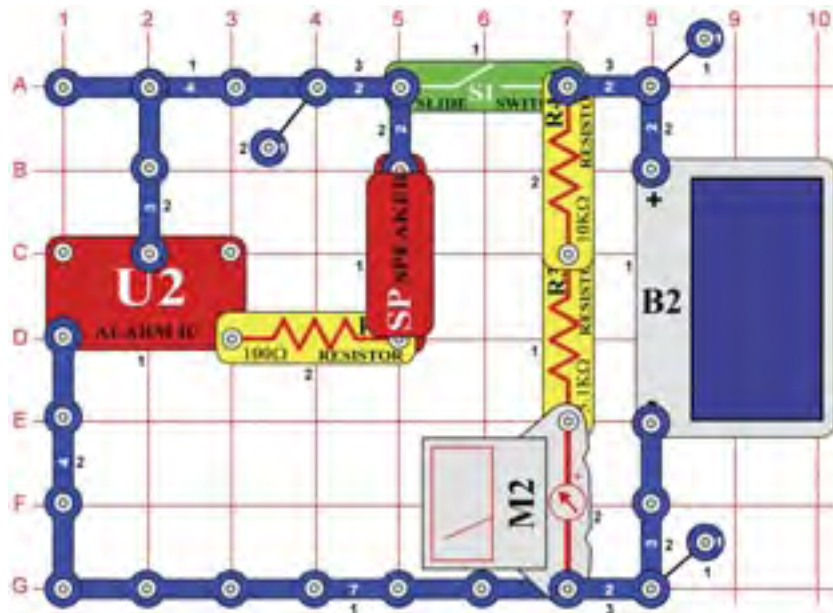

Solar Alarm

OBJECTIVE: To use the sun to make alarm sounds.

Set the meter (M2) to the LOW (or 10mA) scale. With the slide switch (S1) off, make sure you have a bright light on the solar cell (B2) so the meter reads 10 or higher. Now turn on the slide switch and listen to the sound.

The meter is used to measure if the solar cell can supply enough current to operate the alarm IC (U2). Some types of light are better than others, but bright sunlight is best.

Project #560

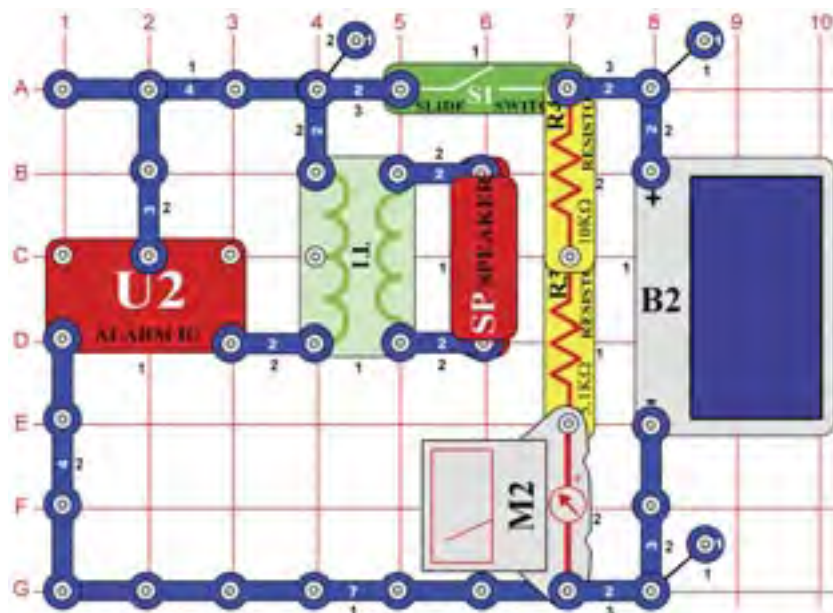

Better Solar Alarm

OBJECTIVE: To use the sun to make alarm sounds.

Set the meter (M2) to the LOW (or 10mA) scale. With the slide switch (S1) off, make sure you have enough light on the solar cell (B2) for the meter to read 8 or higher. Now turn on the slide switch and listen to the sound.

This circuit uses the transformer (T1) to boost the current to the speaker (SP), allowing it to operate with less power from the solar cell. Compare how much light it needs to project #559, which doesn't have a transformer.

You can change the sound from the alarm IC (U2) using the same variations listed in projects #61-65.

Project #561

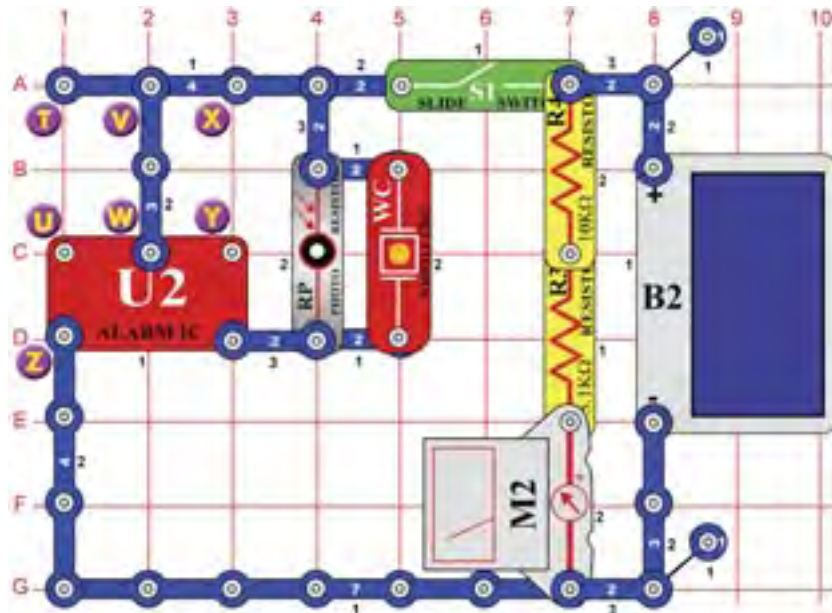

Photo Solar Alarm

OBJECTIVE: *To use the sun to make alarm sounds.*

Set the meter (M2) to the LOW (or 10mA) scale. With the slide switch (S1) off, make sure you have enough light on the solar cell (B2) for the meter to read 6 or higher. Now turn on the slide switch and listen to the alarm. Cover the photoresistor (RP) to stop the alarm.

The whistle chip (WC) needs less power to make noise than the speaker (SP), so this circuit can operate with less light on the solar cell than projects #559 and #560. But the sound from the circuits with the speaker is louder and clearer.

You can change the sound from the alarm IC (U2) using the same variations listed in projects #61-65.

Project #562

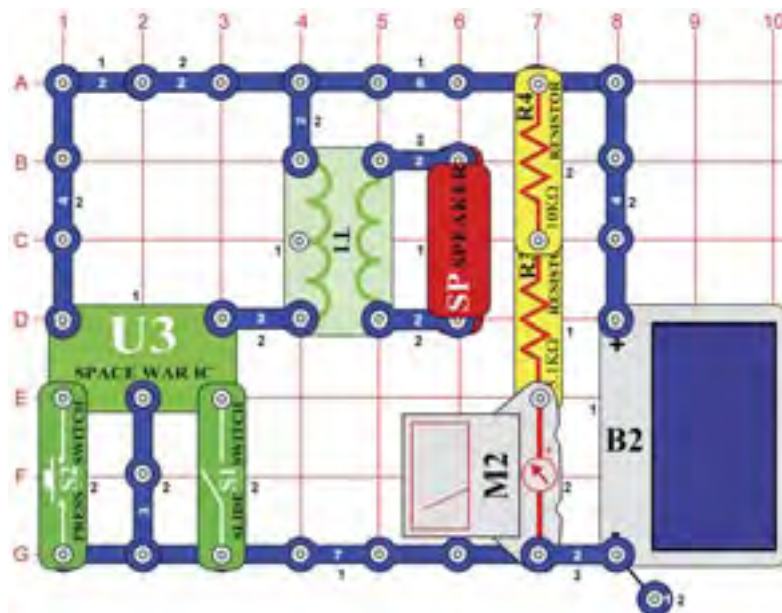

Solar Space War

OBJECTIVE: *To use the sun to make space war sounds.*

Set the meter (M2) to the LOW (or 10mA) scale. With the slide switch (S1) off, make sure you have enough light on the solar cell (B2) for the meter to read 8 or higher. Now turn on the slide switch and listen to the space war sounds.

Project #563

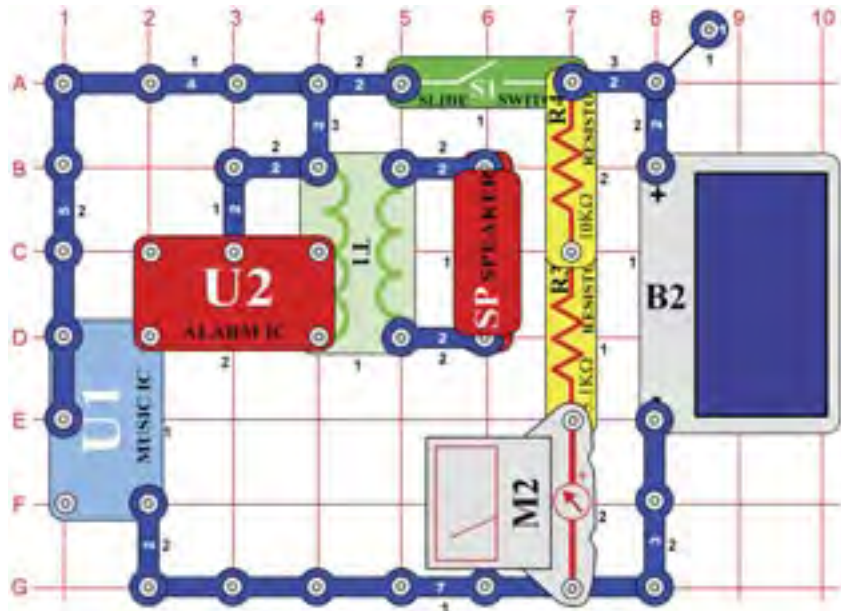

Solar Music Alarm Combo

OBJECTIVE: To use the sun to make a combination of sounds.

Set the meter (M2) to the LOW (or 10mA) scale. With the slide switch (S1) off, make sure you have enough light on the solar cell (B2) for the meter to read 8 or higher. Now turn on the slide switch and listen to the music.

The meter is used to measure if the solar cell can supply enough current to operate the ICs (U1 & U2).

Project #564

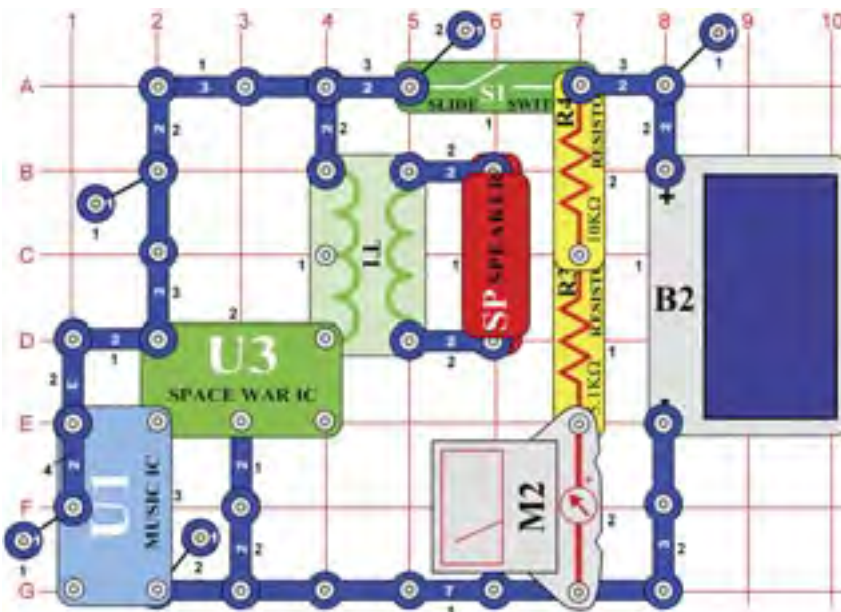

Solar Music Space War Combo

OBJECTIVE: To use the sun to make a combination of sounds.

Set the meter (M2) to the LOW (or 10mA) scale. With the slide switch (S1) off, make sure you have enough light on the solar cell (B2) for the meter to read 8 or higher. Now turn on the slide switch and listen to the music.

Project #565 Solar Music Space War Combo (II)

OBJECTIVE: To use the sun to make a combination of sounds.

Use the circuit from project #564 but replace the speaker (SP) with the whistle chip (WC). Now the light on the solar cell (B2) doesn't have to be as bright for this circuit to work. You can also modify this circuit by replacing the music IC (U1) with the alarm IC (U2).

Project #566

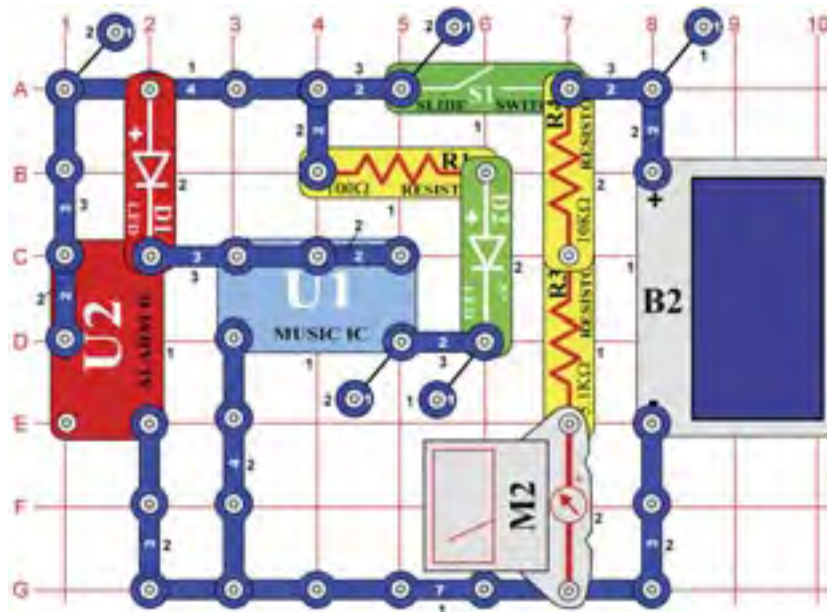

Solar Periodic Lights

OBJECTIVE: To use the sun to flash lights in a repeating pattern.

Set the meter (M2) to the LOW (or 10mA) scale. With the slide switch (S1) off, make sure you have enough light on the solar cell (B2) for the meter to read 9 or higher. Now turn on the slide switch and the LED's (D1 & D2) will alternate being on and off.

Project #567 Solar Periodic Lights (II)

OBJECTIVE: To use the sun to flash lights in a repeating pattern.

Use the circuit in project #566, except remove the 3-snap between the music (U1) and alarm (U2) IC's (base grid locations C2-C4) and add a 2-snap between the music IC and the 100Ω resistor (R1) (base grid B4-C4). The circuit works the same way but the LED flashing patterns are different.

Project #568

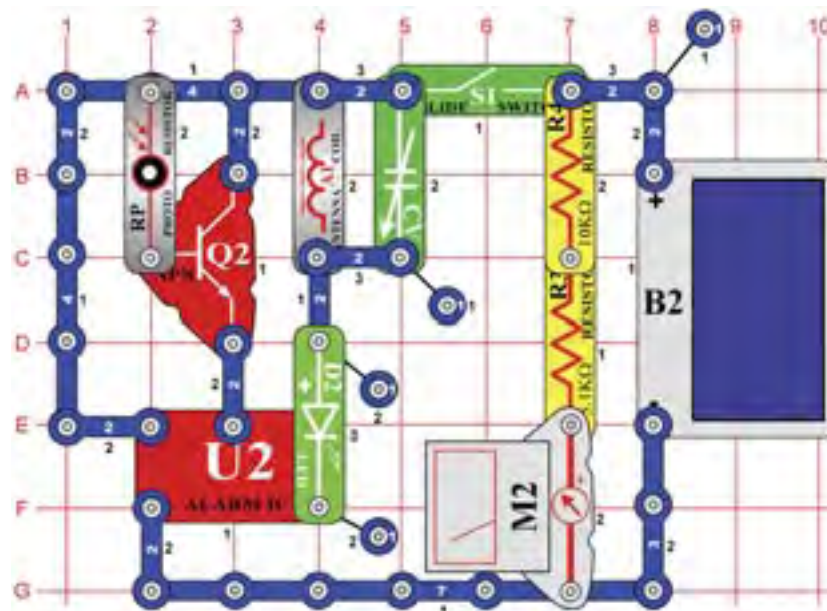

Solar AM Radio Transmitter

OBJECTIVE: To use the sun to power an AM radio transmitter.

You need an AM radio for this project. Place it next to your circuit and tune the frequency to where no other station is transmitting.

Set the meter (M2) to the LOW (or 10mA) scale. With the slide switch (S1) off, make sure you have enough light on the solar cell (B2) for the meter to read 9 or higher. Turn on the slide switch and adjust the variable capacitor (CV) for the best sound on the radio. Cover the photoresistor (RP) to change the sound pattern.

Project #569



Low Light Noisemaker

OBJECTIVE: *To build a sun-powered oscillator circuit.*

Set the meter (M2) to the LOW (or 10mA) scale. With the slide switch (S1) off, make sure you have light on the solar cell (B2) for the meter to read at least 5 but less than 10.

Turn on the slide switch and it should make a whining sound, adjust the amount of light to the solar cell to change the frequency of the sound. Use a brighter light or partially cover the solar cell if there is no sound at all.

Project #570 Low Light Noisemaker (II)

OBJECTIVE: *To build a sun-powered oscillator circuit.*

Use the circuit from project #569 but replace the whistle chip (WC) with the 0.1µF capacitor (C2) to lower the frequency of the sound. The circuit works the same way.

Project #571 Low Light Noisemaker (III)

OBJECTIVE: *To build a sun-powered oscillator circuit.*

Use the circuit from project #569 but replace the whistle chip (WC) with the 10µF capacitor (C3, "+" on the right) to lower the frequency of the sound. The circuit works the same way but you hear a ticking sound instead of a whining sound.

Project #572

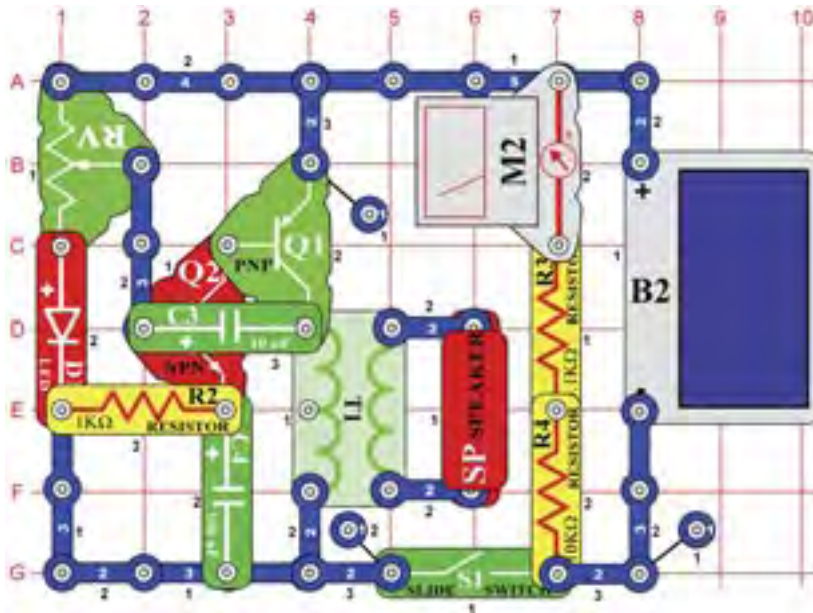

Solar Oscillator

OBJECTIVE: To build a sun-powered oscillator circuit.

Set the meter (M2) to the LOW (or 10mA) scale. With the slide switch (S1) off, make sure you have enough light on the solar cell (B2) for the meter to read 8 or higher. Now turn on the slide switch and adjust the adjustable resistor (RV).

You will hear a clicking sound like raindrops or a whine, depending upon how much light there is.

Project #573 Solar Oscillator (II)

OBJECTIVE: To build a sun-powered oscillator circuit.

Use the circuit from project #572 but replace the 10µF capacitor (C3) with the 0.02µF or 0.1µF capacitors (C1 & C2) to make the sound a high-pitch whine.

Project #574

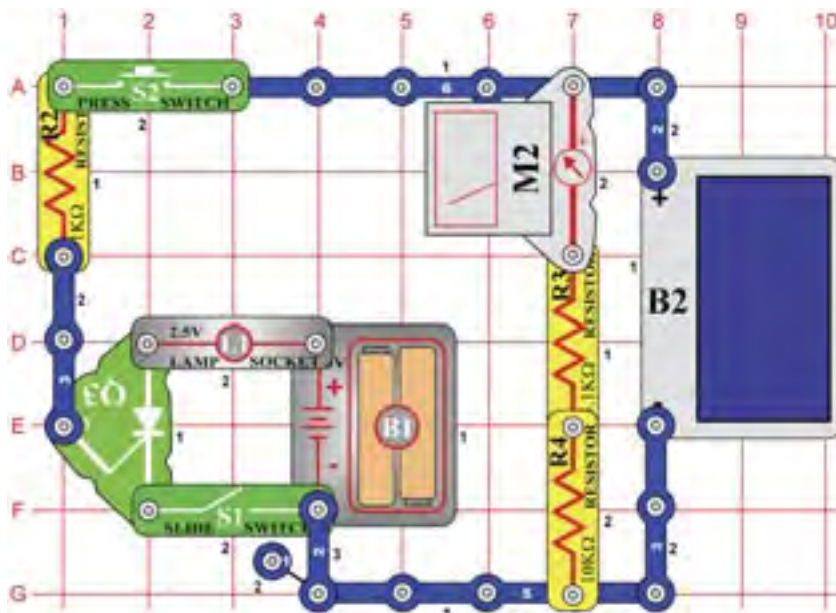

Daylight SCR Lamp

OBJECTIVE: To learn the principle of an SCR.

Set the meter (M2) to the LOW (or 10mA) scale. Make sure you have enough light on the solar cell (B2) for the meter to read 3 or higher.

Turn on the slide switch (S1), the lamp (L1) stays off. Push the press switch (S2) and the SCR (Q3) turns on the lamp and keeps it on. You must turn off the slide switch to turn off the lamp.

The SCR is a controlled diode. It lets current flow in one direction, and only after a voltage pulse is applied to its control pin. This circuit has the control pin connected to the press switch and solar cell, so you can't turn it on if the room is dark.

Project #575

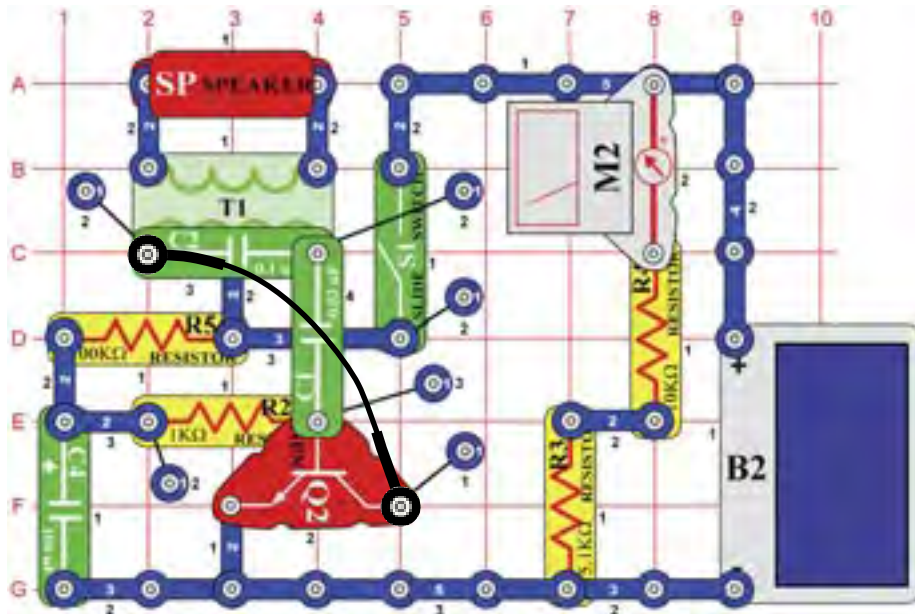

OBJECTIVE: *To build a sun-powered oscillator circuit.*

Set the meter (M2) to the LOW (or 10mA) scale. With the slide switch (S1) off, make sure you have enough light on the solar cell (B2) for the meter to read 9 or higher. Now turn on the slide switch and listen to the sound.

For variations on this circuit, replace the 100 μ F capacitor (C4) with the 10 μ F capacitor (C3) or replace the speaker (SP) with the whistle chip (WC).

Project #576

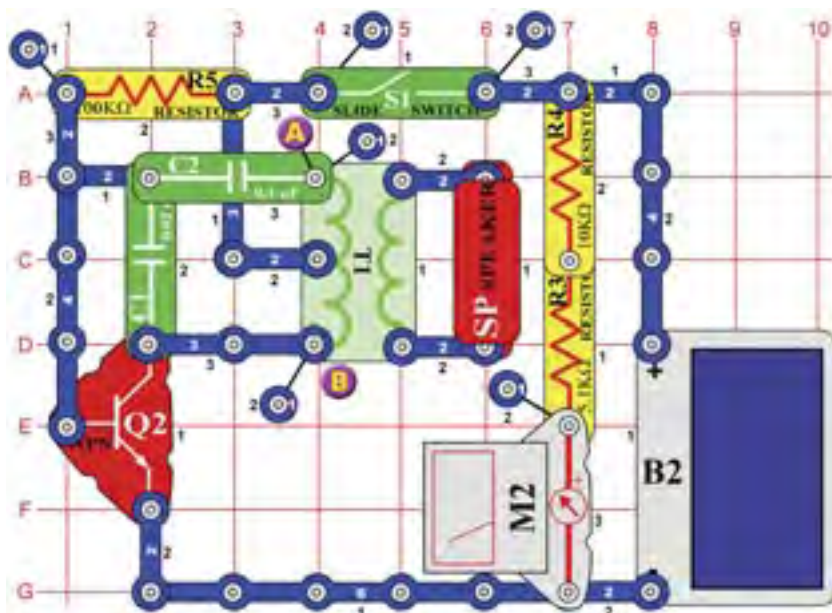

OBJECTIVE: *To build a sun-powered oscillator circuit.*

Set the meter (M2) to the LOW (or 10mA) scale. With the slide switch (S1) off, make sure you have enough light on the solar cell (B2) for the meter to read 9 or higher. Now turn on the slide switch and listen to the sound.

For variations on this circuit, install the whistle chip (WC) above the 0.02 μ F capacitor (C1), or install it across points A & B and remove the speaker (SP).

Project #577

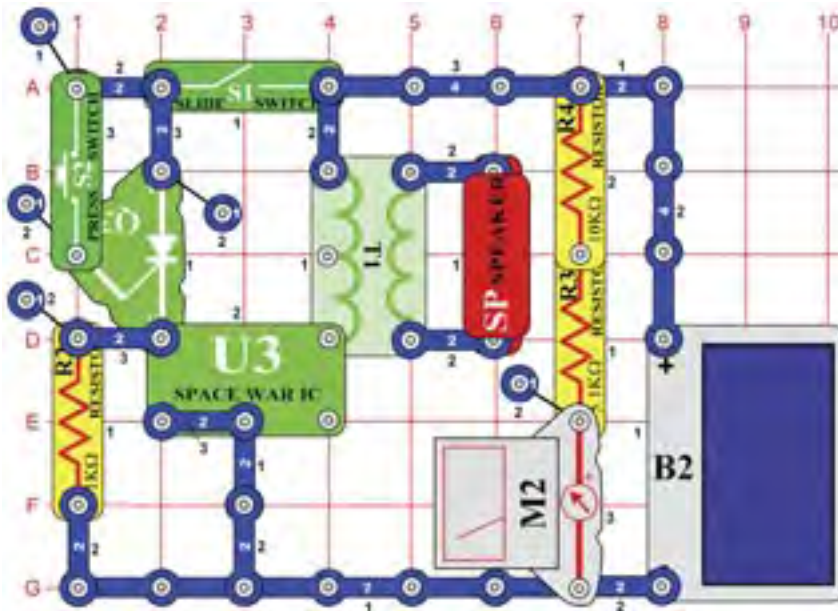

SCR Solar Bomb Sounds

OBJECTIVE: To learn the principle of an SCR.

Set the meter (M2) to the LOW (or 10mA) scale. With the slide switch (S1) off, make sure you have enough light on the solar cell (B2) for the meter to read 8 or higher. Turn on the slide switch now; nothing happens. Press the press switch (S2) and you hear an explosion of sounds, which continues until you turn off the slide switch.

Project #578

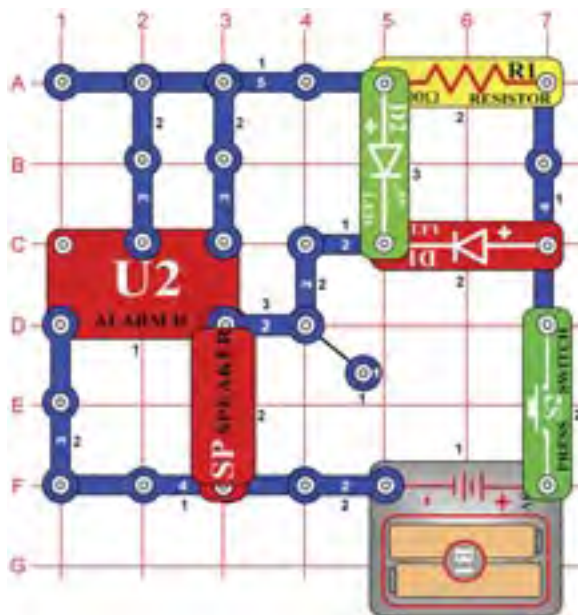

Flashing Laser LED's with Sound

OBJECTIVE: To build a laser sounding circuit.

When you press the press switch (S2), the integrated circuit (U2) should sound like a laser gun. The red (D1) and green (D2) LED's will flash simulating a burst of light. You can shoot long repeating laser bursts or short zaps by tapping the press switch.

Project #579

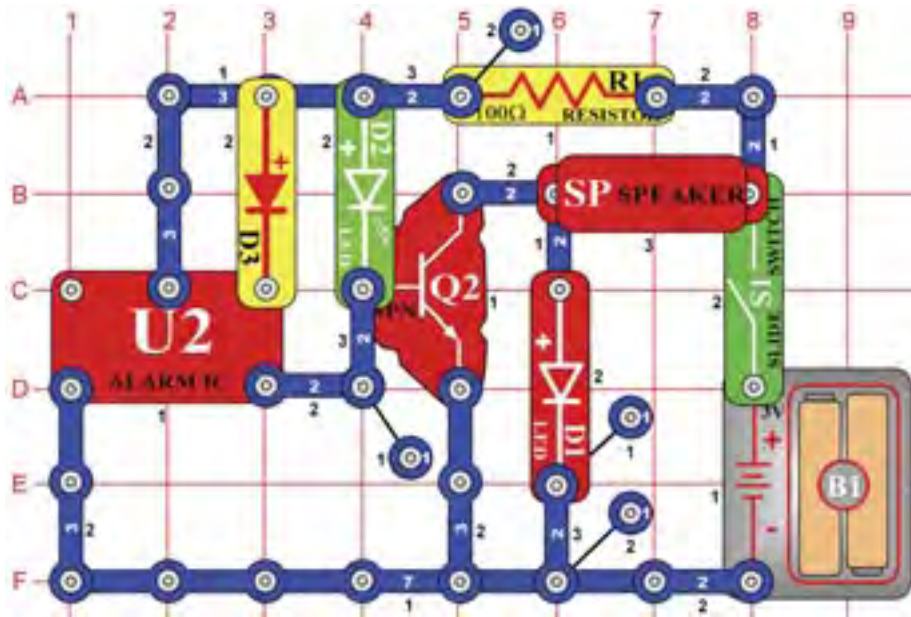

U2 with Transistor Amplifier

OBJECTIVE: To combine U2 with an amplifier.

Turn the slide switch (S1) on and the LED's (D1 & D2) flash as the speaker (SP) sounds. The output pulses from U2 turns transistor Q2 on and off rapidly. As the transistor turns on, the speaker shorts to ground and a current flows through it. The current flow through the speaker causes it to produce a sound. The LED's show the pulsing signal from U2 that is turning Q2 on and off.

Project #580 U2 with Transistor Amplifier (II)

OBJECTIVE: To combine U2 with an amplifier.

Using project #579, remove the diode (D3) to create a different sound.

Project #581 U1 with Transistor Amplifier (III)

OBJECTIVE: To combine U1 with an amplifier.

Using the project #579, replace U2 with U1. The circuit will now play music.

Project #582

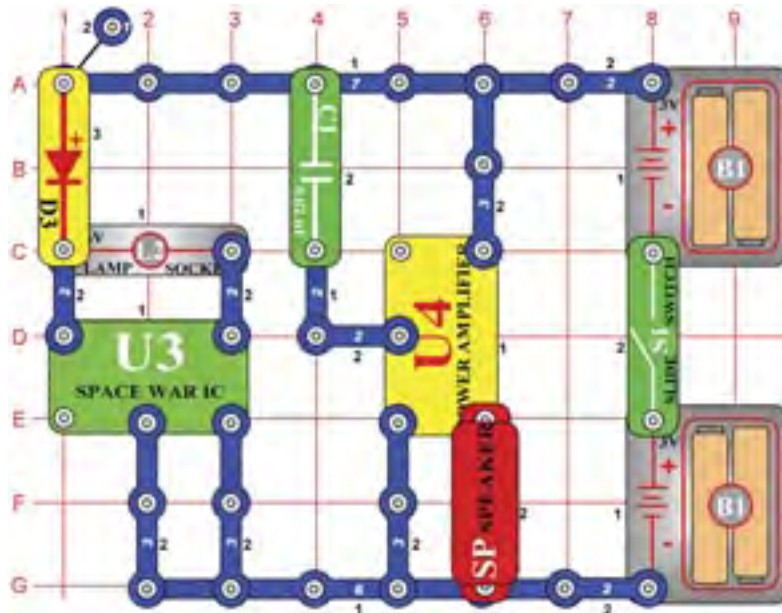

Loud Sounds

OBJECTIVE: To create a sound circuit.

Turn the slide switch (S1) on and you should hear a tone from the speaker (SP).

Project #583

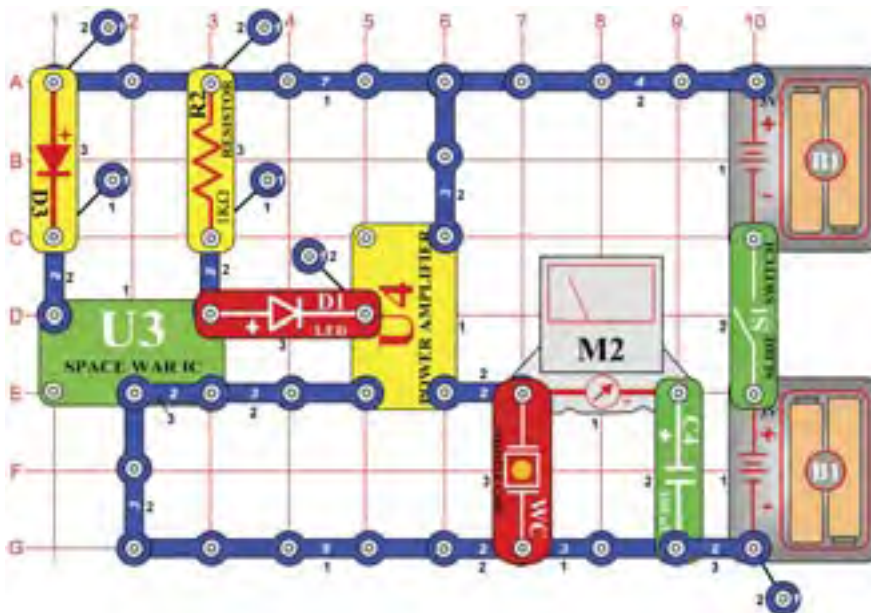

Swinging Meter with Sound

OBJECTIVE: To see and hear the output from the Space War IC.

Set the meter (M2) to the LOW (or 10mA) scale. In this project, you will see and hear the output from the space war IC (U3). The power amplifier IC (U4) amplifies the signal from U3 in order to drive the whistle chip (WC) and meter. Turn on the slide switch (S1). The meter deflects back and forth, as the LED (D1) flashes and the whistle chip sounds. Replace the whistle chip with the speaker (SP) for a louder sound. Note that the meter will deflect very little now. Almost all the signal is across the speaker due to its low resistance.

Project #584

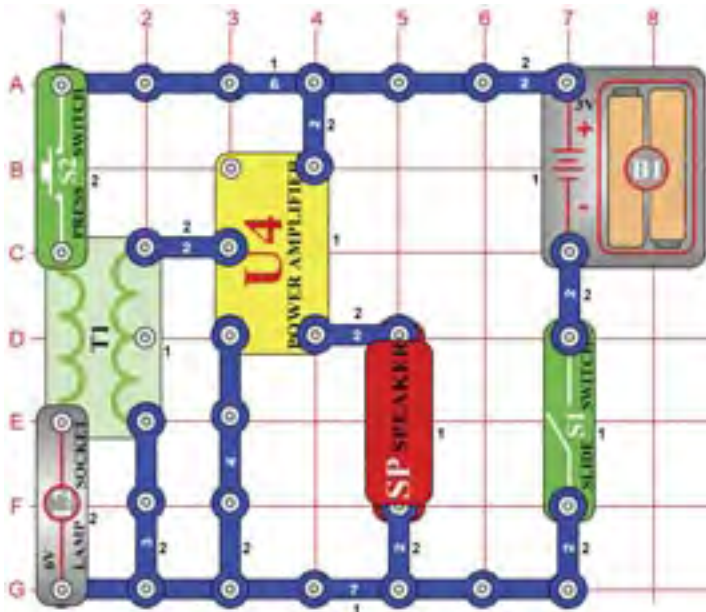

Motor Sound Using Transformer

OBJECTIVE: To create a sound circuit.

Turn the slide switch (S1) on and then rapidly turn on and off the press switch (S2). This causes a magnetic field to expand and collapse in the transformer (T1). The small voltage generated is then amplified by the power amplifier IC (U4) and the speaker (SP) sounds. Replace switch S2 with the motor (M1, leave the fan off) and you can hear how fast the motor spins. To hear the sound better, connect the speaker to the circuit using the red and black jumper wires (instead of the 2-snaps) and hold it next to your ear.

WARNING: Moving parts. Do not touch the fan or motor during operation.

Project #585



Motor Sound with LED

OBJECTIVE: To create a sound circuit.

In this project, you will drive the whistle chip (WC) and LED's using the motor (M1) and transformer (T1). Turn the slide switch (S1) on. The motor begins spinning and the red LED (D1) lights. Now press the press switch (S2), the voltage generated from the transformer is now across the whistle chip and green LED (D2). The whistle chip sounds as the green LED lights.

WARNING: Moving parts. Do not touch the fan or motor during operation.

Project #586 Motor Sound with LED (II)

OBJECTIVE: To create a sound circuit.

Modify project #585 by replacing the 6V lamp (L2) with the speaker (SP). Now the speaker (SP) will also output sound.

Project #587

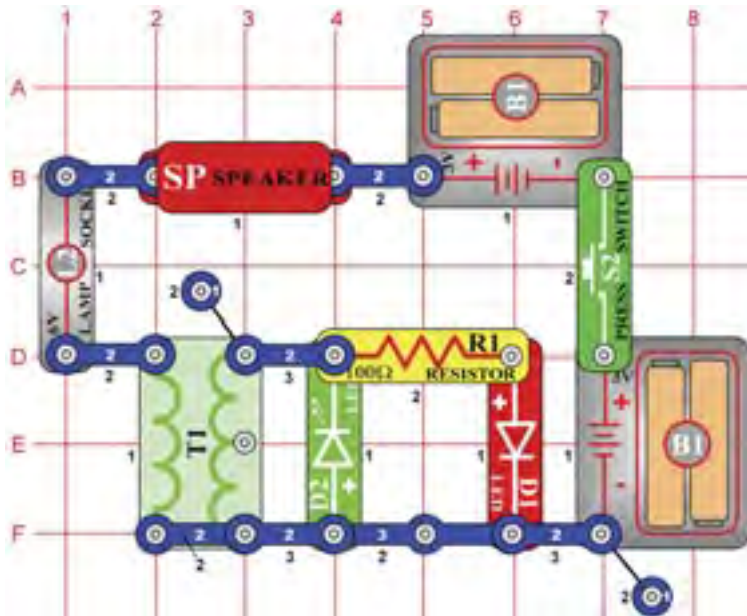

AC & DC Current

OBJECTIVE: Using AC and DC current.

This circuit creates an AC & DC current. Press the press switch (S2) a few times and the LED's flash back and forth. Turning the switch on and off causes the magnetic field in the transformer (T1) to expand (green LED D2 lights) and collapse (red LED D1 lights) and current flows in two directions. Hold the switch down and the green LED flashes once. Replace the 6V lamp (L2) with the motor (M1). Press the press switch, the red LED flickers and the speaker sounds, due to the small current change from the motor spinning.

Project #588

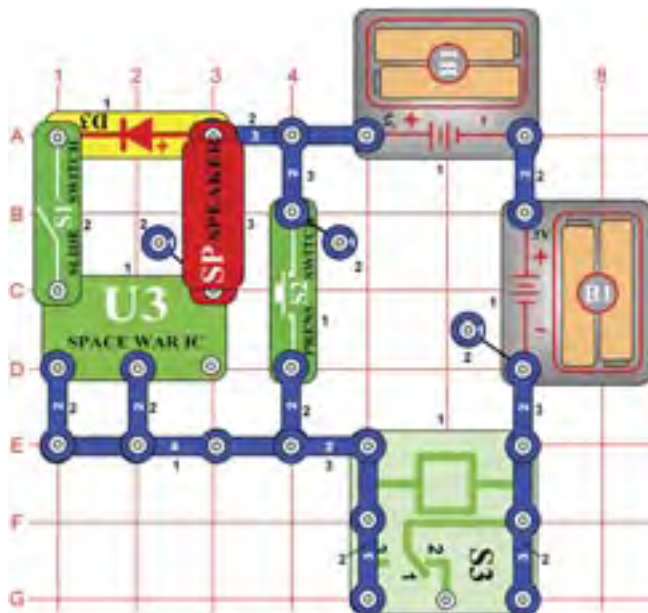

Noisemaker

OBJECTIVE: To create a sound circuit.

Turn on the slide switch (S1) and the relay (S3) generates a buzzing noise. Increase the voltage across the relay by pressing the press switch (S2). The tone is higher because the relay's contacts are opening and closing faster.

Project #589

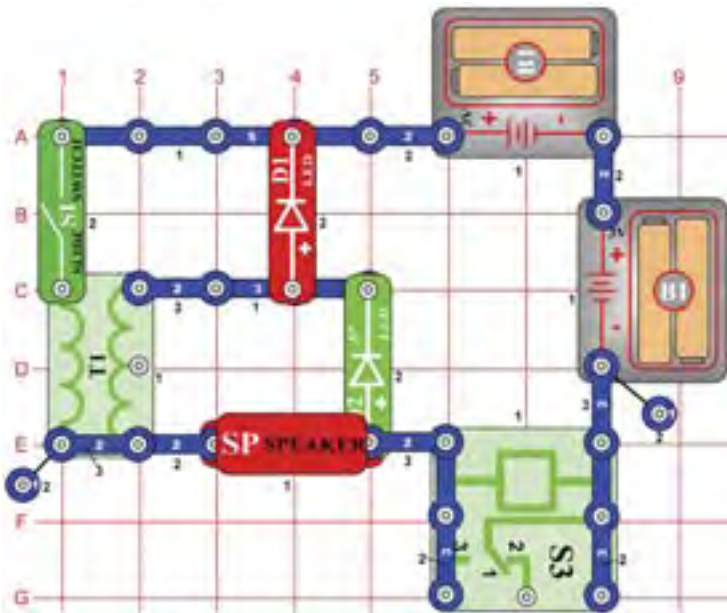

AC Voltage

OBJECTIVE: To use AC voltage.

Turn the slide switch (S1) on. The LED's (D1 & D2) flash so fast that they appear to be on, and the speaker (SP) sounds. As in other projects, the relay's (S3) contacts open and close rapidly. This causes the magnetic field in the transformer (T1) to expand and collapse, creating an AC voltage lighting the LED's.

Project #590

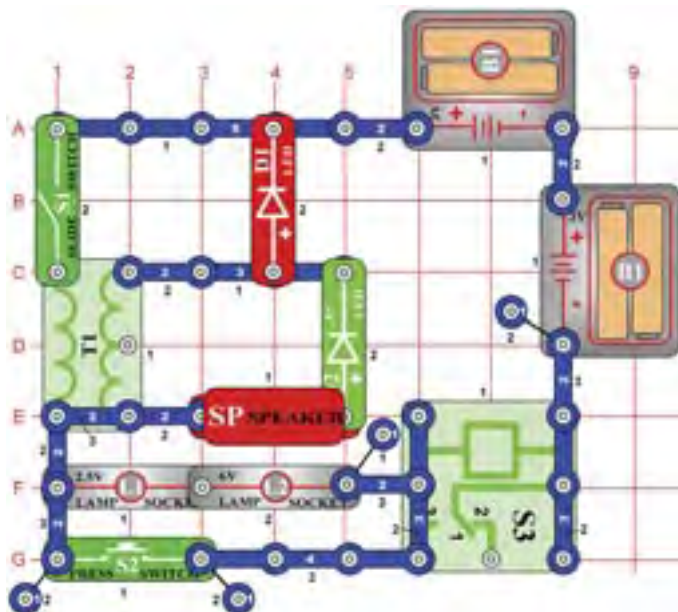

AC Voltage (II)

OBJECTIVE: To use AC voltage.

You can modify project #589 by adding the press switch (S2) and two light bulbs (L1 & L2). When the slide switch (S1) is turned on, the relay (S3) sounds and the light bulbs and LED's (D1 & D2) flash. Pressing the press switch shorts the light bulbs and speaker (SP).

Project #591

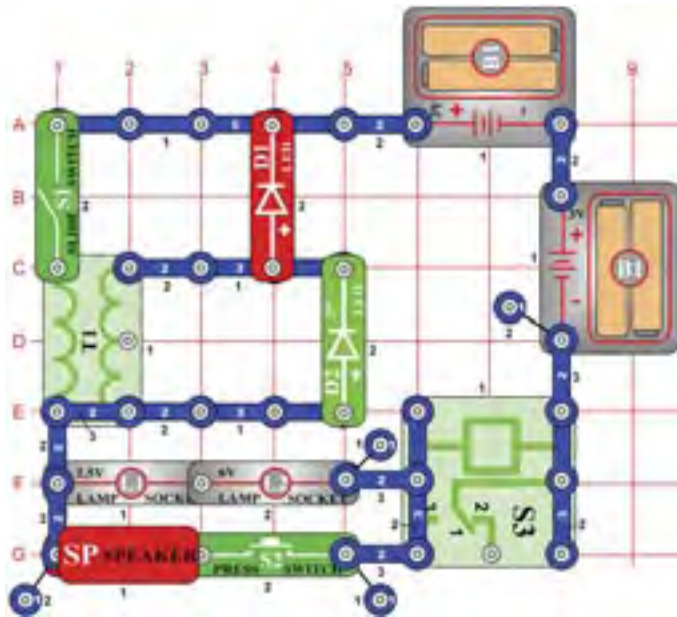

AC Voltage (III)

OBJECTIVE: To use AC voltage.

This project is similar to project #589. When the slide switch (S1) is turned on, the relay (S3) sounds and the light bulbs (L1 & L2) and LED's (D1 & D2) flash. Now when the press switch (S2) is pressed, the speaker (SP) also sounds.

Project #592

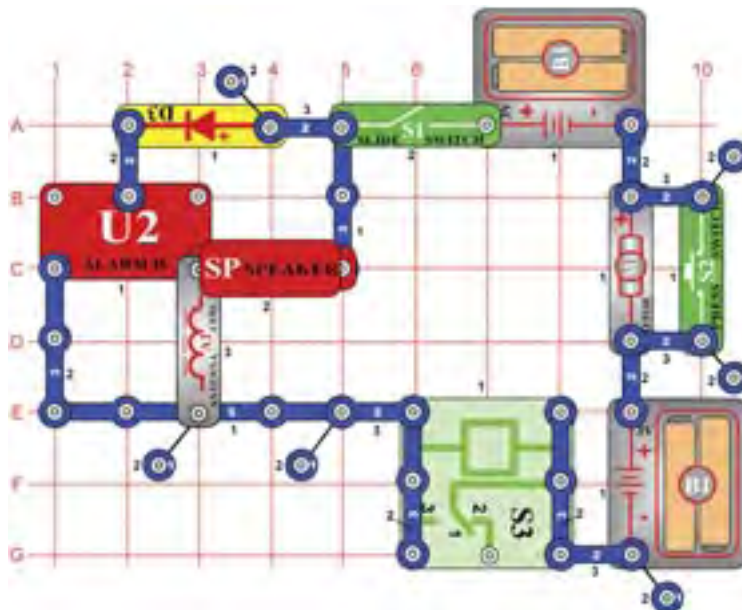

Noisemaker (II)

OBJECTIVE: To create a sound circuit.

Turn on the slide switch (S1) and the relay (S3) generates a buzzing noise. Increase the voltage across the relay by pressing the press switch (S2). The tone changes because the relay's contacts are opening and closing faster.

WARNING: Moving parts. Do not touch the fan or motor during operation.

WARNING: Do not lean over the motor.

Project #593

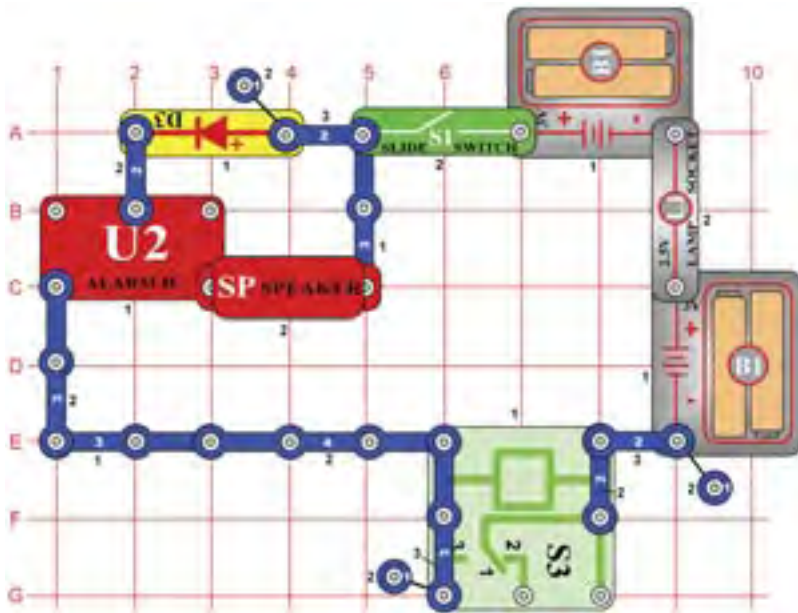

Noisemaker (III)

OBJECTIVE: To create a sound circuit.

Turn the slide switch (S1) on and the speaker (SP) sounds as if a motor is spinning and an alarm is running. The relay's (S3) contacts rapidly open and close the battery connection to the circuit causing the alarm IC (U2) sound to be different.

Project #594

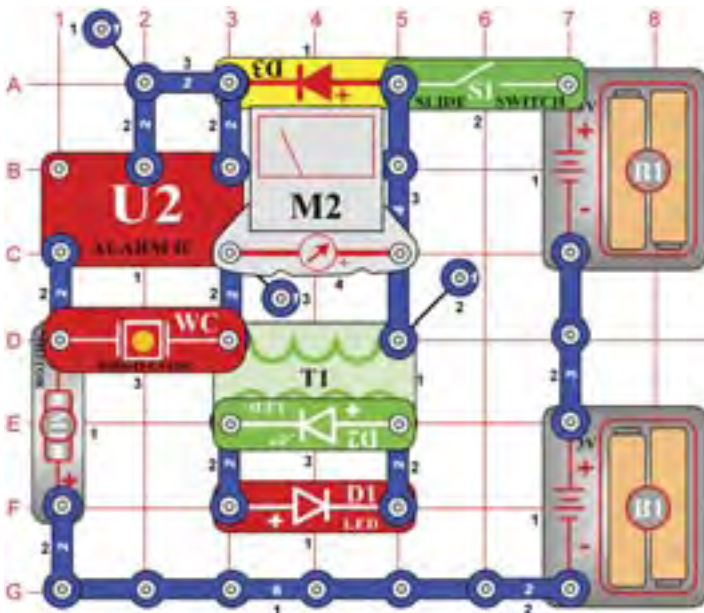

Pulsing Motor

OBJECTIVE: To create a pulsing motor circuit.

Set the meter (M2) to the LOW scale. Turn on the slide switch (S1) and now you have a pulsing motor and LED's circuit. Replace the meter with the 470 μ F capacitor (C5, "+" on right) to change the rate the LED's (D1 & D2) flash.



WARNING: Moving parts. Do not touch the fan or motor during operation.

Project #595

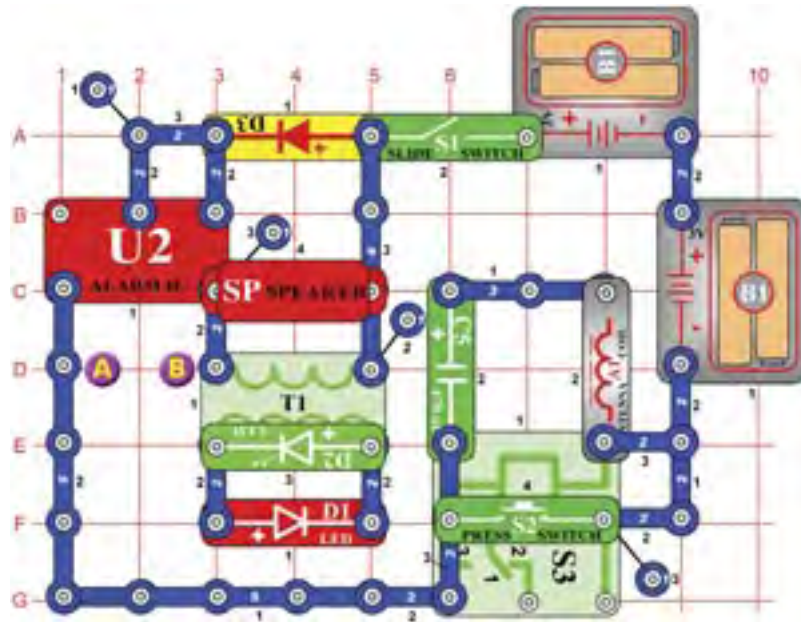

Noisemaker (IV)

OBJECTIVE: To create a sound circuit.

In this project, you'll see and hear the output of the alarm IC (U2). Turn on the slide switch (S1), the LED's (D1 & D2) flash, and the speaker (SP) sounds as the relay (S3) chatters. Now press the press switch (S2) and see what happens when you remove the relay from the circuit.

Project #596 Noisemaker (V)

OBJECTIVE: To create a sound circuit.

Modify the sound of project #595 by adding capacitor C4 across points A & B (+ of C4 on right).

Project #597 Noisemaker (VI)

OBJECTIVE: To create a sound circuit.

Modify project #596 by replacing the capacitor C4 with the motor (M1, position it with the "+" on the left and don't place the fan on it). Turn on the slide switch (S1), the LED's flash, and the speaker (SP) sounds as the relay (S3) chatters. Now press the press switch (S2) removing the relay from the circuit, providing a constant connection to the battery (B1). The motor speeds up and the sound from the speaker is not distorted.

WARNING: Moving parts. Do not touch the fan or motor during operation.

Project #598 Noisemaker (VII)

OBJECTIVE: To create a sound circuit.

Modify project #597 replacing the speaker (SP) with the whistle chip (WC) and placing the fan onto the motor (M1). Turn on the slide switch (S1) and the fan spins, lights flash, and the relay (S3) chatters. Now try to launch the fan by pressing the press switch (S2) down for about five seconds and releasing it.

WARNING: Moving parts. Do not touch the fan or motor during operation.

WARNING: Do not lean over the motor.

Project #599 Noisemaker (VIII)

OBJECTIVE: To create a sound circuit.

Modify project #598 by removing the motor (M1). Turn on the slide switch (S1) and press the press switch (S2) to hear the new sound.

Project #600 Noisemaker (IX)

OBJECTIVE: To create a sound circuit.

Modify the sound of project #599 by replacing the whistle chip (WC) with the meter (M2, "+" towards right), use the LOW (or 10mA) meter setting. Turn on the slide switch (S1) and as the LED's flash the meter deflects.

Project #601

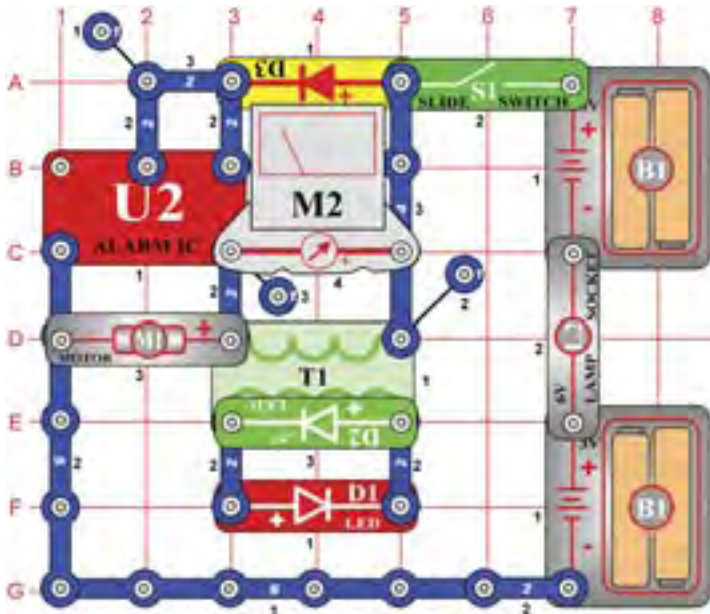

Alarm Power

OBJECTIVE: To create a sound circuit.

In this project, the alarm IC (U2) powers the motor (M1), meter (M2) and LED's (D1 & D2). Leave the fan off of the motor. Set the meter to the LOW (or 10mA) position and turn on the slide switch (S1). The circuit pulses the meter, motor, and LED's.



WARNING: Moving parts. Do not touch the motor during operation.

Project #602 Alarm Power (II)

OBJECTIVE: To create a sound circuit.

Remove the motor (M1) from the circuit and now the circuit pulses around 1Hz.

Project #603 Night Sounds

OBJECTIVE: To hear the sounds of the night.

Simulate the sound of a forest at night by replacing the motor (M1) in project #601 with the whistle chip (WC).

Project #604

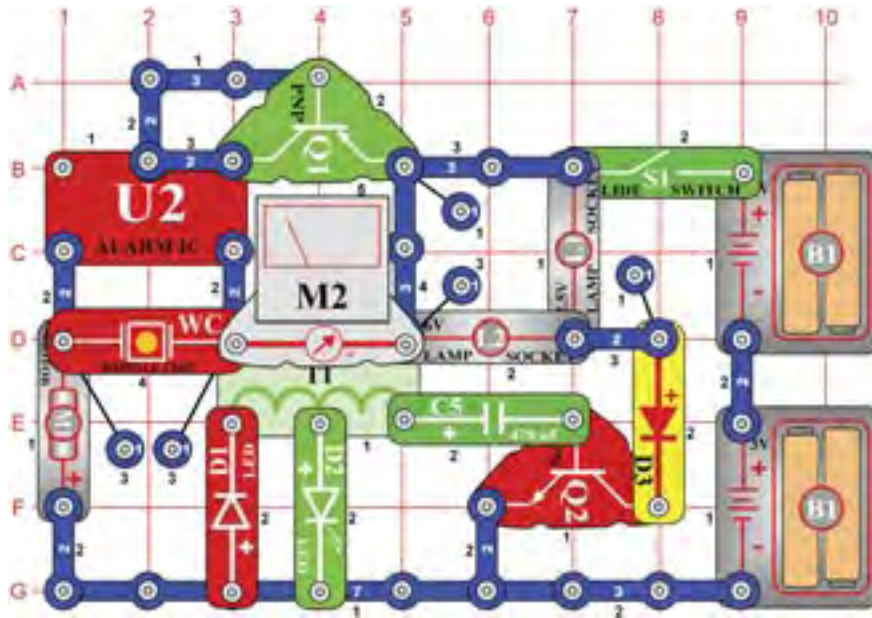

Mega Pulsar & Flasher

OBJECTIVE: To power other devices using the alarm IC.

In this circuit, you will power many devices using the alarm IC (U2). Set the meter (M2) to LOW (or 10mA) and turn on the slide switch (S1). The LED's (D1 & D2) and bulbs (L1 & L2) flash, the meter deflects, the whistle chip (WC) sounds, and the motor (M1) spins.

WARNING: Moving parts. Do not touch the fan or motor during operation.

Project #605



"E" & "S" Blinker

OBJECTIVE: To use the alarm IC to flash between "E" & "S".

This circuit alternately displays letters "E" and "S" by switching segments "E" and "C" on and off. Segments A, D, F, and G are connected to ground so they are always lit. Segment "C" is connected to the base of Q2 and output of U2. The segment "E" is connected to the collector of Q2. When the output of U2 is low, segment "C" is on and "E" is off. When the U2's output is high, the transistor (Q2) turns on and segment "C" turns off. When the transistor connects the "E" segment to ground the segment lights, displaying the letter "S".

Project #606

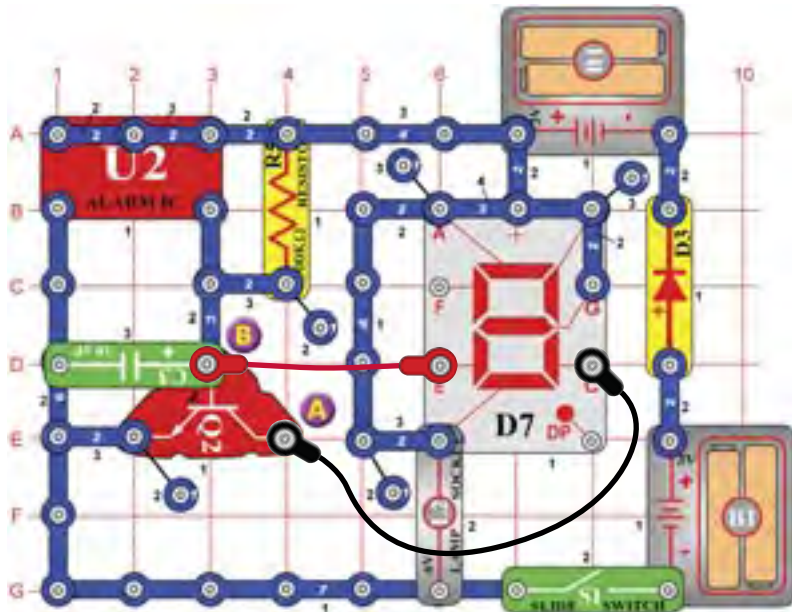

"2" & "3" Blinker

OBJECTIVE: To use the alarm IC to flash between "2" & "3".

The circuit switches between numbers "2" & "3" on the display.
Place jumpers from point A to segment C and point B to segment E.

Project #607

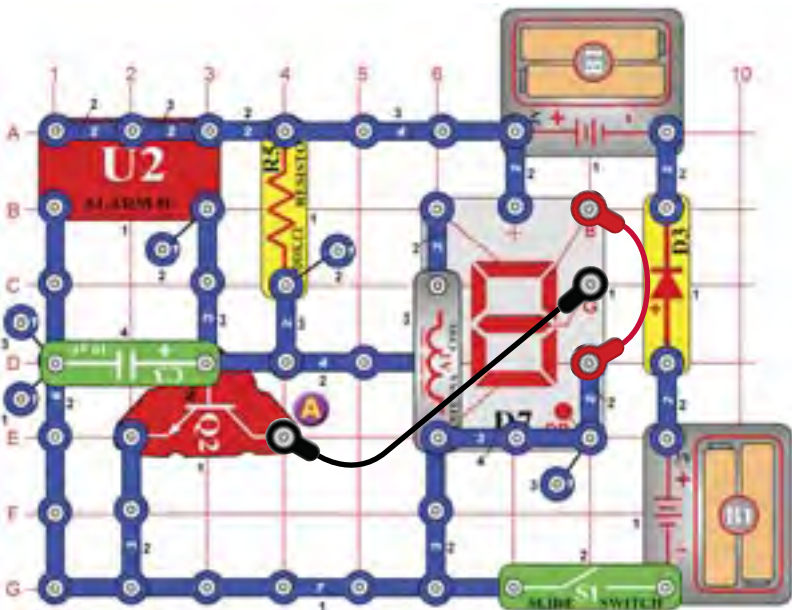

"9" & "0" Blinker

OBJECTIVE: To use the alarm IC to flash between "9" & "0".

The circuit switches between numbers "9" and "0" on the display.
Place a jumper from point A to segment G and segment B to segment C.

Project #608

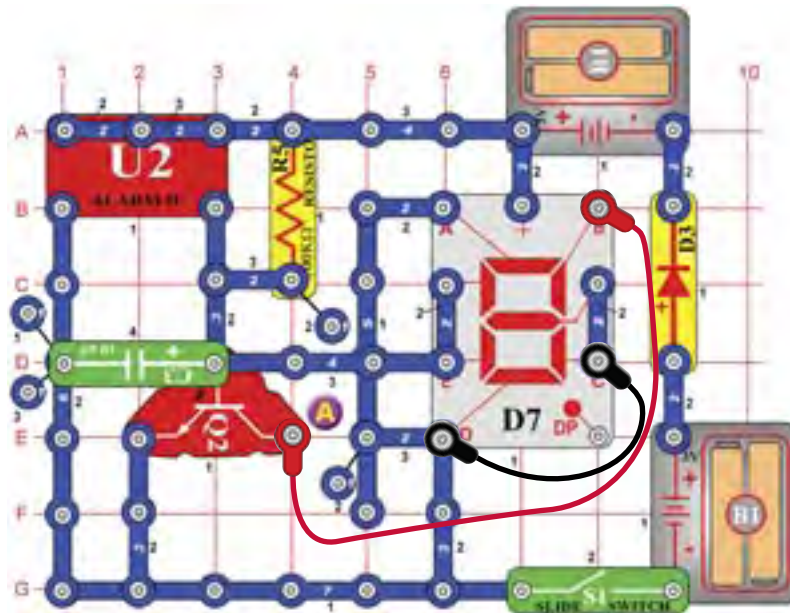

"3" & "6" Blinker

OBJECTIVE: To use the alarm IC to flash between "3" & "6".

The circuit switches between numbers "3" & "6" on the display. Place a jumper from segment C to segment D and segment B to point A.

Project #609

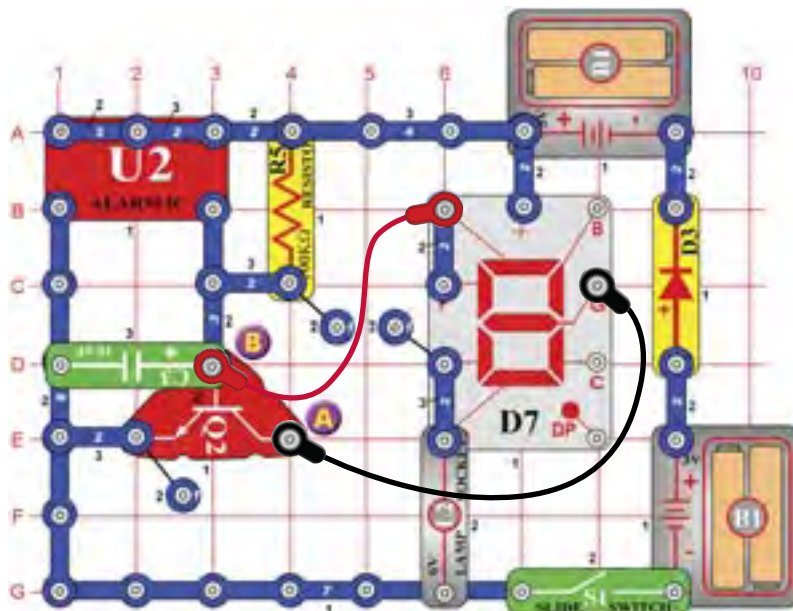

"c" & "C" Blinker

OBJECTIVE: To use the alarm IC to flash between "c" & "C".

The circuit switches between letters "c" & "C" on the display. Place a jumper from point A to segment G and point B to segment A.

Project #610

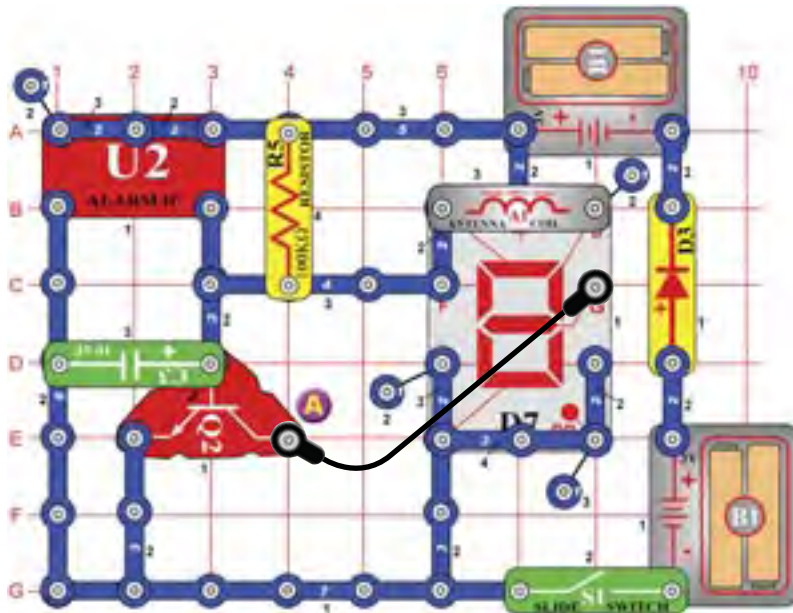

"O" & "o" Blinker

OBJECTIVE: To use the alarm IC to flash between "O" & "o".

The circuit switches between upper case "O" and lower case "o". Place a jumper from point A to segment G. The DP segment will also light.

Project #611

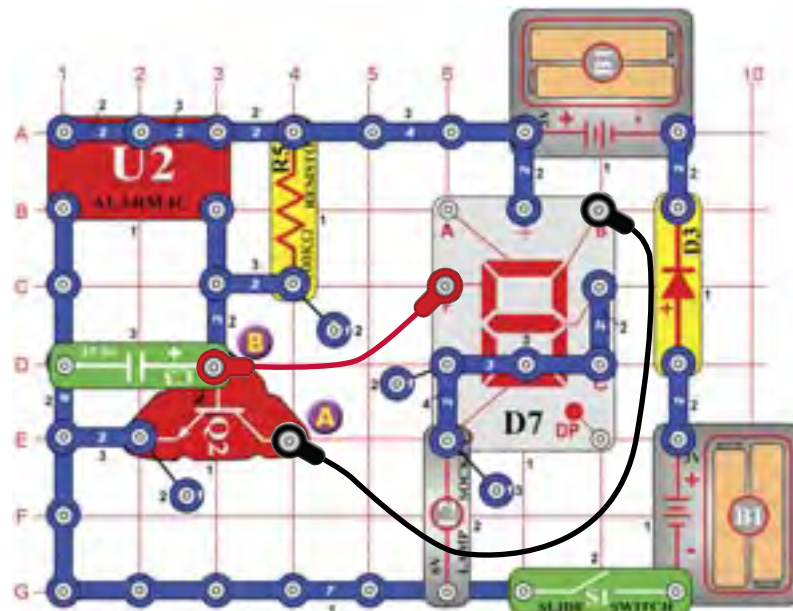

"b" & "d" Blinker

OBJECTIVE: To use the alarm IC to flash between "b" & "d".

The circuit switches between letters "b" & "d" on the display. Place a jumper from point A to segment B and point B to segment F.

Project #612

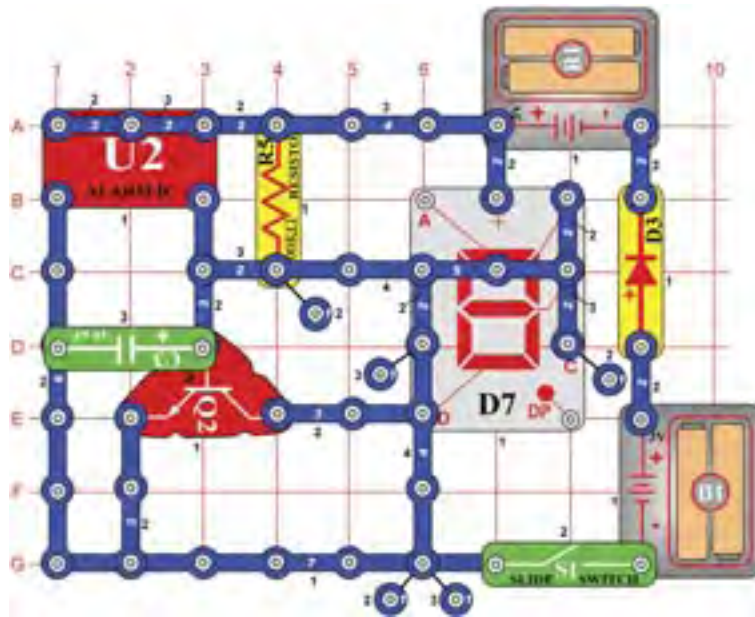

"H" & "L" Blinker

OBJECTIVE: To use the alarm IC to flash between "H" & "L".

The circuit switches between letters "H" & "L" on the display.

Project #613

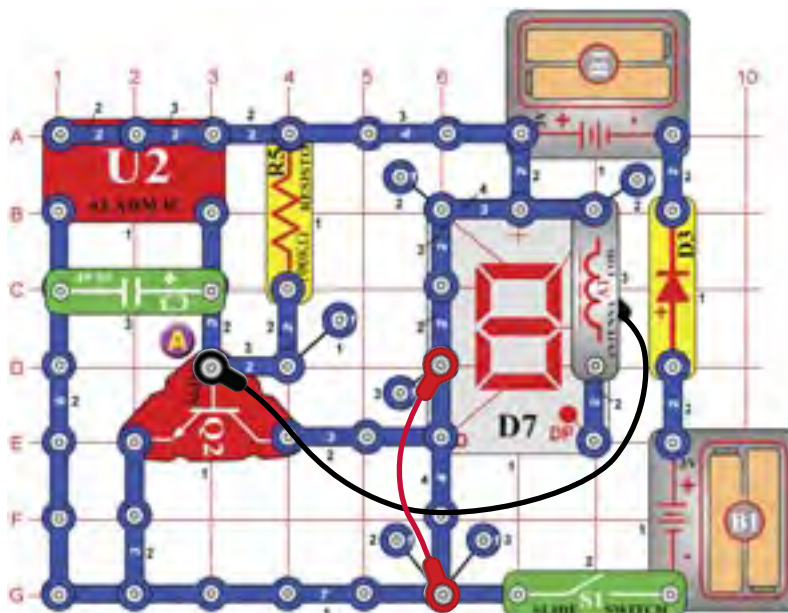

"A" & "O" Blinker

OBJECTIVE: To use the alarm IC to flash between "A" & "O".

The circuit switches between letters "A" & "O" on the display.
Place a jumper from point A to segment G. The DP segment will also light.

Project #614

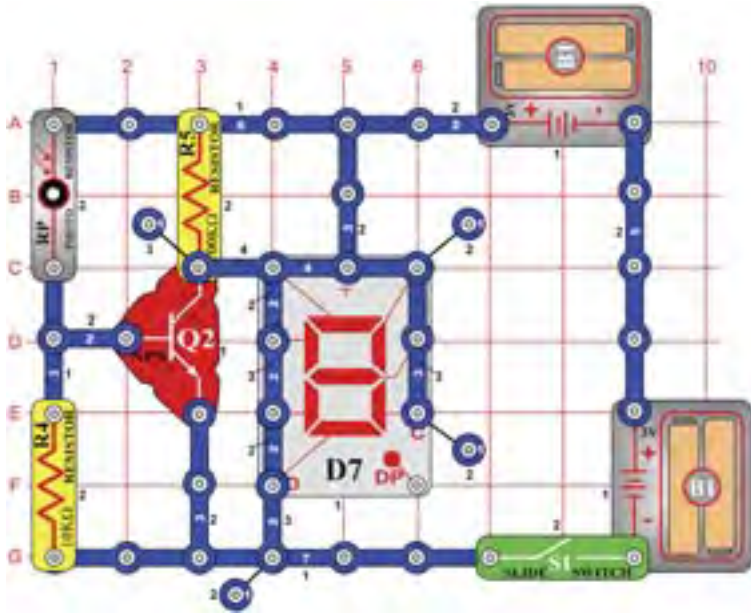

Open & Closed Indicator

OBJECTIVE: To construct a circuit that indicates if a door is open or closed using light.

Switching from letters "O" to "C" requires turning off segments B & C. Turn on the slide switch (S1), the display lights an "O" indicating an open door. Cover the photoresistor (RP) with your hand (closed door) and the letter "C" lights. The photoresistor turns Q2 on and off depending on the amount of light. When Q2 is on (light on RP) the voltage at the collector is low, lighting segments B & C. Covering the RP turns Q2 off and the collector voltage is high now. Segments B & C turn off and the letter "C" lights.

Project #615

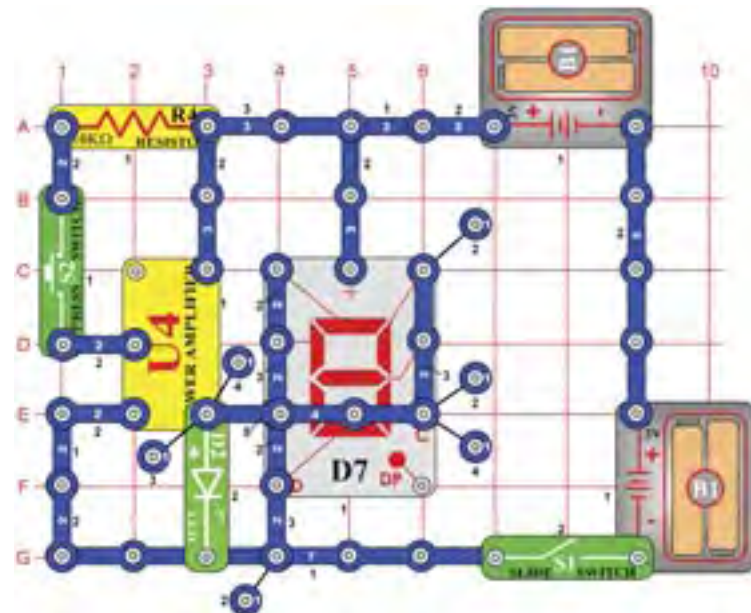

Open & Closed Indicator (II)

OBJECTIVE: To construct a circuit that indicates if a switch is open or closed using U4.

As in project #614, the display will light an "O" or "C" indicating if the press switch (S2) is on or off. Turn on the slide switch (S1), the LED (D2) and letter "O" lights. With no input to U4 the LED lights and the voltage decreases enough so segments B & C light. Press the press switch S2, the LED turns off and the letter "C" lights. The voltage at U4's output increased enough turning the segments off.

Project #616 Vibration Indicator

OBJECTIVE: To construct a circuit that indicates vibration.

Modify project #615 by replacing the press switch (S2) with the whistle chip (WC). As you tap the whistle chip, U4's output voltage changes, lighting the LED (D2) and changing the display from "C" to "O".

Project #617

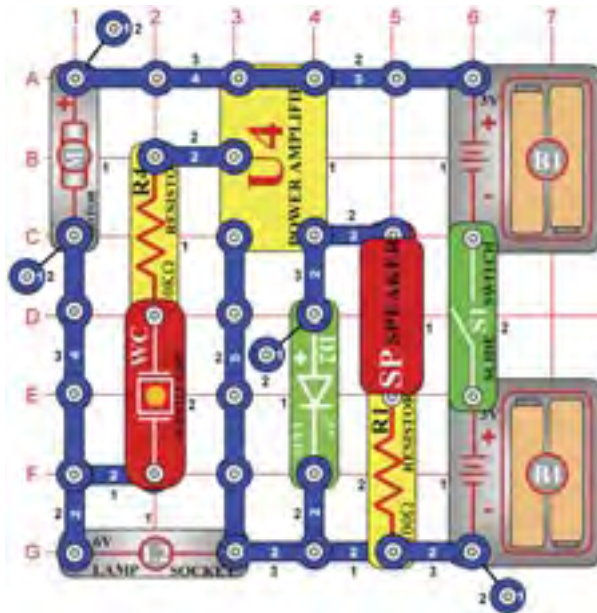

Vibration Sounder

OBJECTIVE: To construct a circuit that indicates vibration.

As the motor (M1) spins, it generates an AC voltage amplified by U4. The output from U4 lights the LED (D2) and makes noise from the speaker (SP). With the fan not installed, turn on the slide switch (S1) and you hear the high tone of the spinning motor. Now, install the fan and hear the difference.

WARNING: Moving parts. Do not touch the fan or motor during operation.

Project #618

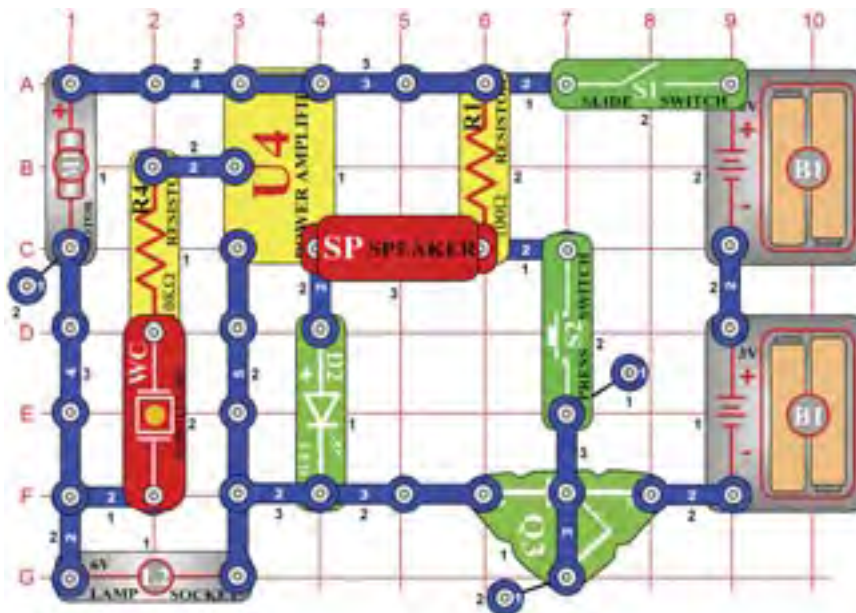

SCR Noise Circuit

OBJECTIVE: To use the SCR to start a circuit.

Turn on the slide switch (S1) and nothing happens. The SCR (Q3) connects the circuit to the batteries and, until the SCR's gate goes high, the circuit is off. Press the press switch (S2) and the motor (M1) spins and the LED (D2) and bulb (L2) light. Increase the sound from the speaker (SP) by pressing the press switch.

WARNING: Moving parts. Do not touch the fan or motor during operation.

Project #619

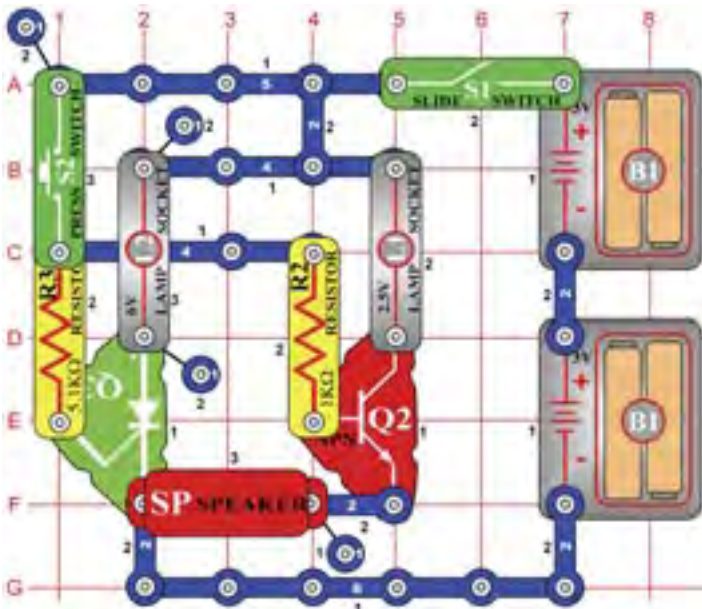

SCR & Transistor Switch

OBJECTIVE: Control bulbs L1 & L2 with an SCR and transistor.

Turn the slide switch (S1) on and then press the press switch (S2), both bulbs (L1 & L2) light, but only L2 stays on when S2 is released. To stay on, the transistor (Q2) requires a continuous voltage but the SCR only needs a pulse. The speaker (SP) may not make any sound.

Project #620

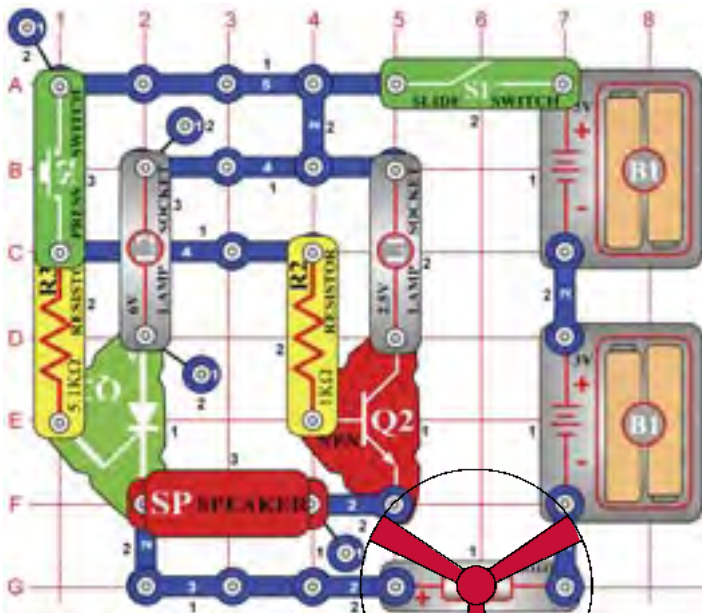

Two-speed Motor

OBJECTIVE: Increase the speed of a motor using an SCR and transistor.

If you turn on either switch (S1 or S2) alone, nothing happens. But if you turn on the slide switch (S1) and then press the press switch (S2), the lamps (L1 & L2) light and the motor (M1) spins. The SCR (Q3) keeps the 6V lamp (L2) on and the motor spinning after you release the press switch. If you hold the press switch down, then the 2.5V lamp (L1) stays on and the motor spins faster.

WARNING: Moving parts. Do not touch the fan or motor during operation.

WARNING: Do not lean over the motor.

Project #621

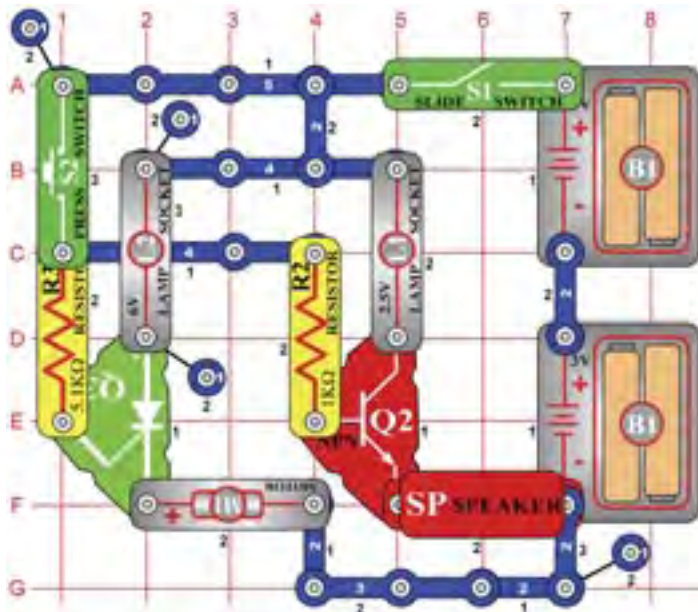

Two-speed Motor (II)

OBJECTIVE: To decrease the speed of a motor using an SCR and transistor.

Instead of increasing the motor's speed as in project #620, pressing the press switch (S2) decreases the speed. In this circuit, the transistor (Q2) is in parallel with the SCR (Q3). Pressing S2 turns on Q2 and the voltage across the motor (M1) decreases.

WARNING: Moving parts. Do not touch the fan or motor during operation.

Project #622

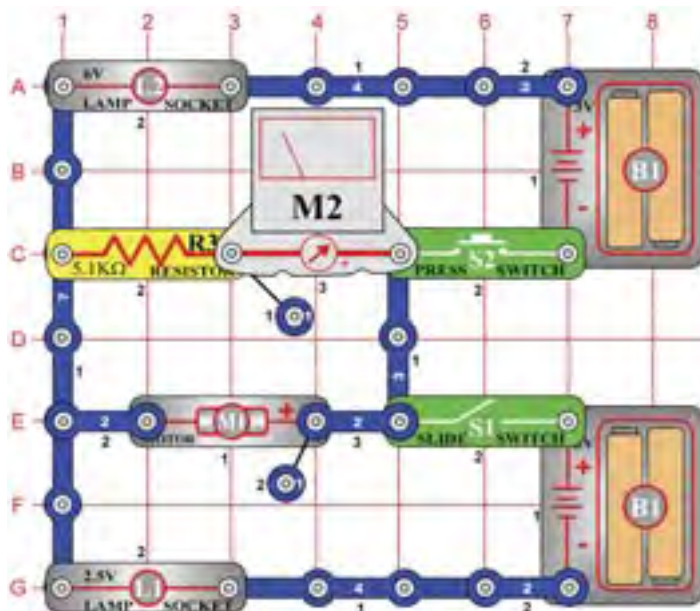

Current Flow

OBJECTIVE: To show the effects of current flow.

Set the meter (M2) to the LOW (or 10mA) position. Turning on the slide switch (S1) connects the motor (M1), meter and 2.5V lamp (L1) to the lower battery (B1) pack. The motor rotates clockwise and the meter deflects right. Now turn off the slide switch and press the press switch (S2). Now, current from the upper battery causes the motor to rotate in the opposite direction. If you place the batteries in series by turning on the slide switch and then pressing the press switch, only the bulbs (L1 & L2) light.

WARNING: Moving parts. Do not touch the fan or motor during operation.

Project #623

AM Radio with Power LED's

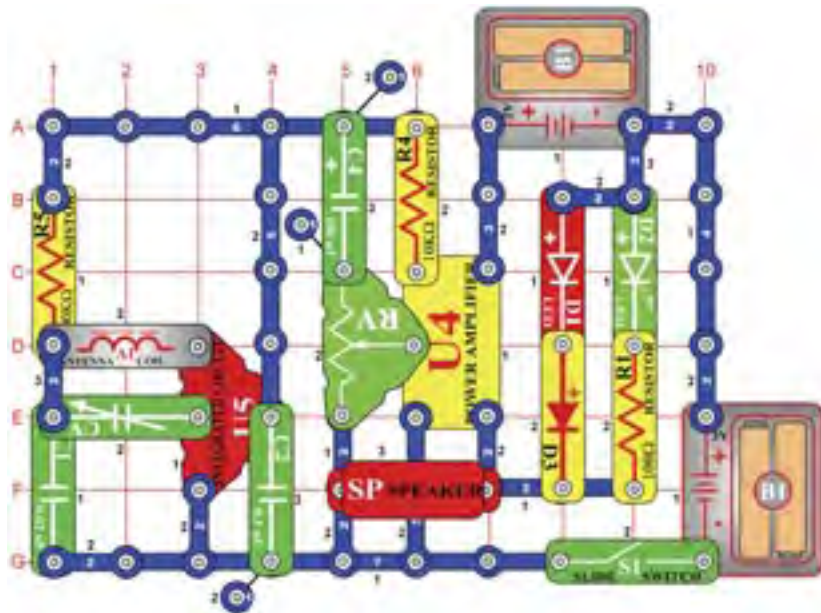

OBJECTIVE: To build an AM radio with LED's.

Set the adjustable resistor (RV) to the middle position and turn the slide switch (S1) on. Tune the radio by adjusting the variable capacitor (CV). The LED's (D1 & D2) flicker as the sound is heard.

Project #624

Space War IC Recording

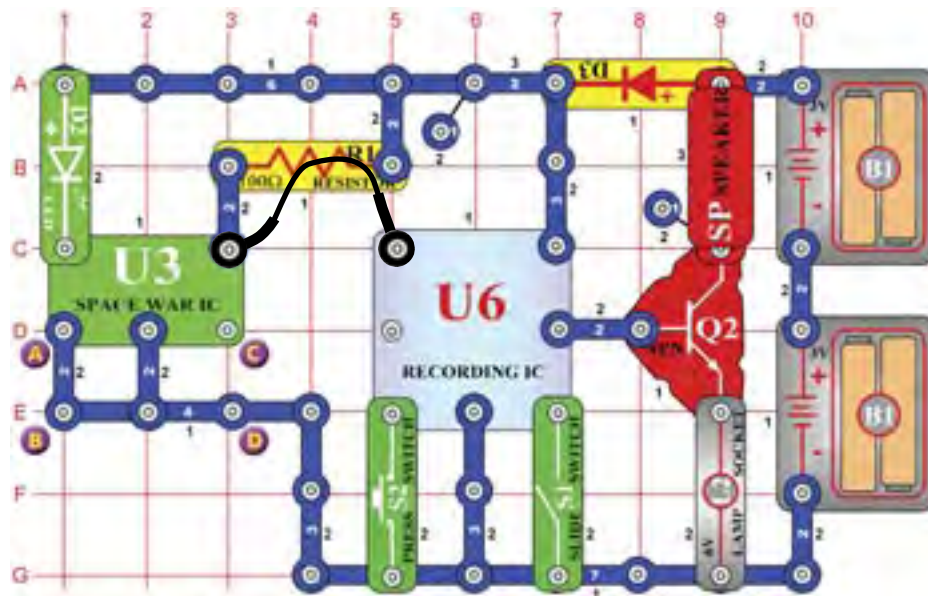

OBJECTIVE: To record the sounds from the space war IC.

The circuit records the sounds from the space war IC (U3) into the recording IC (U6). Turn on the slide switch (S1) and the first beep indicates that the IC has begun recording. When you hear two beeps, the recording has stopped. Turn off the slide switch and press the press switch (S2). You will hear the recording of the space war IC before each song is played. The lamp (L2) is used to limit current and will not light.

Place the 2-snap from points A & B onto C & D. Now record a different sound from U3.

Project #625

LED Flasher

OBJECTIVE: To construct an LED flasher.

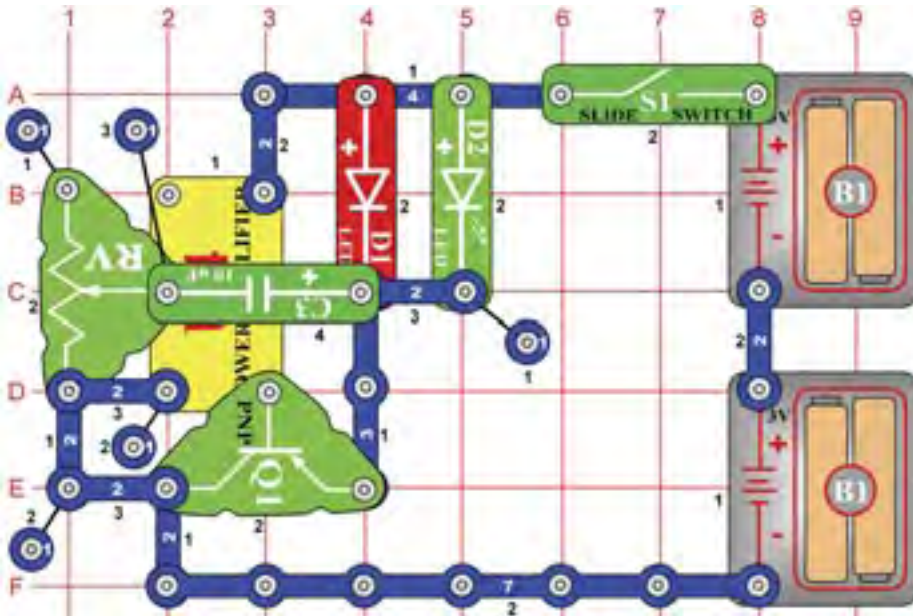

Set the adjustable resistor (RV) to the top position and then turn on the slide switch (S1). The LED's (D1 & D2) flash at a rate of once per second. As you adjust RV's knob down, the LED's flash faster. When RV is at the bottom, the LED's turn off.

Project #626

LED Flasher with Sound

OBJECTIVE: To construct an LED flasher with sound.

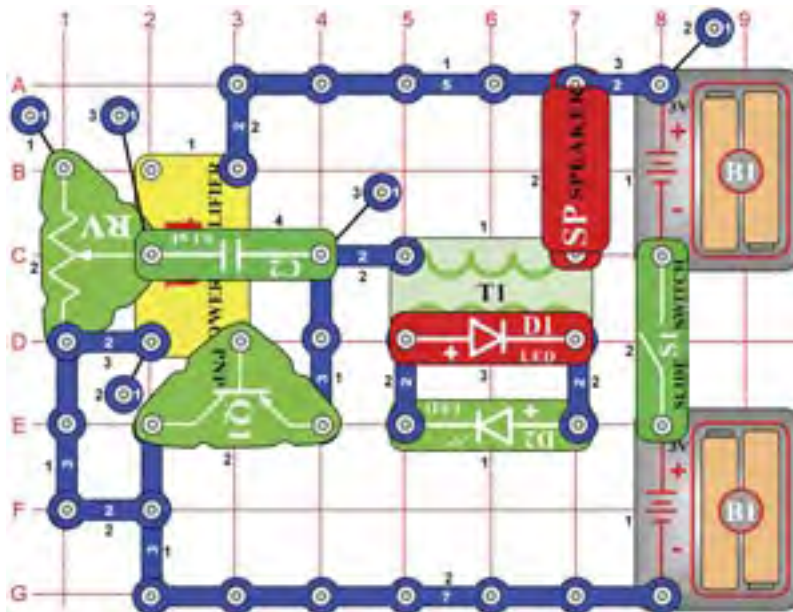

You can modify project #625 by adding a transformer (T1) to drive a speaker (SP). Set the adjustable resistor (RV) to the top position and turn on the slide switch (S1). The speaker sounds as the LED (D2) flashes several times per second. Increase the rate by moving RV's knob down.

Project #627 LED Flasher with Sound (II)

OBJECTIVE: To construct an LED flasher with sound.

Modify the frequency by replacing the $0.1\mu\text{F}$ capacitor (C2) with the $10\mu\text{F}$ capacitor (C3, "+" side on the right).

Project #628

Stepper Motor

OBJECTIVE: To build a variable stepper motor.

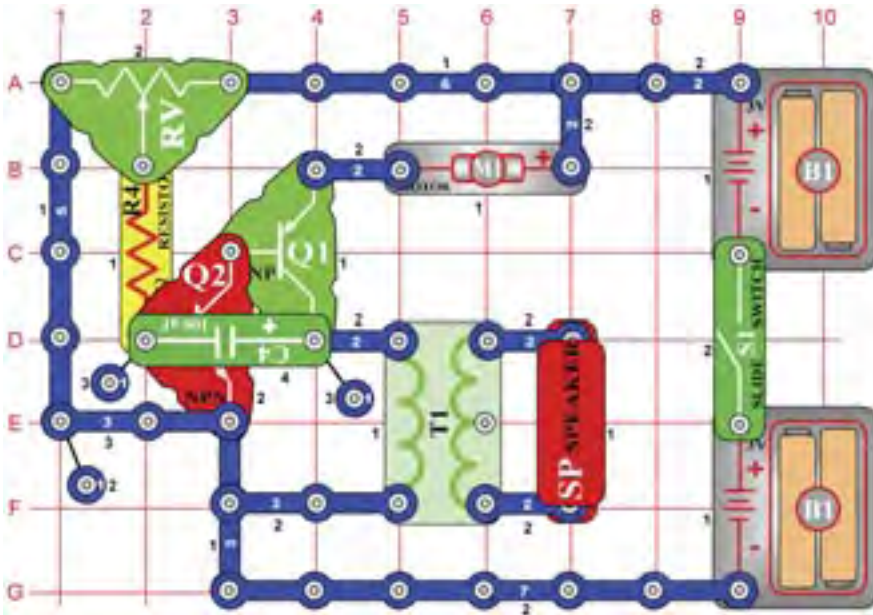

Adjust the adjustable resistor (RV) to the middle position and turn on the slide switch (S1). As the circuit oscillates, the motor (M1) moves a short distance as the speaker (SP) sounds. Adjust the adjustable resistor to different positions seeing how it affects the motor and speaker.

WARNING: Moving parts. Do not touch the fan or motor during operation.

Project #629

Crazy Music IC

OBJECTIVE: To change the sound of the music IC.

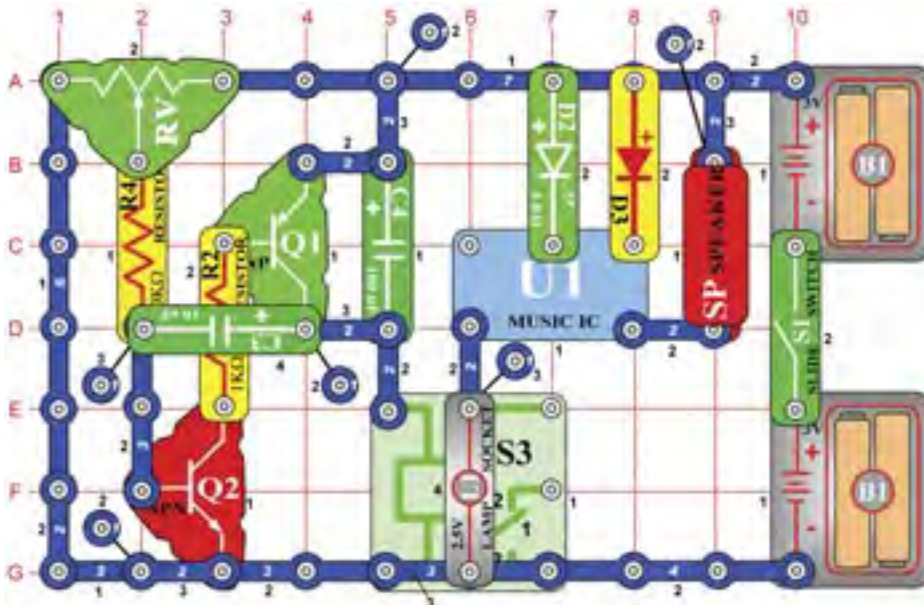

Set the adjustable resistor (RV) to the far left position and turn the slide switch (S1) on. The relay's (S3) contacts open and close shorting U1 to ground, causing the sound level to change.

Project #630

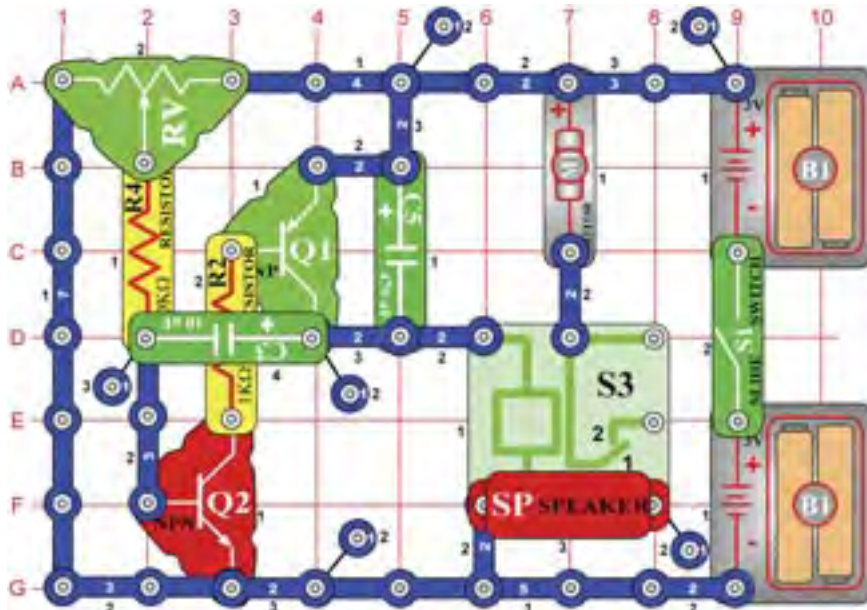

Stepper Motor w/ Sound

OBJECTIVE: To add sound to a stepper motor circuit.

Set the adjustable resistor (RV) to the middle position. Turn the slide switch (S1) on and the motor (M1) pulses on and off as the speaker (SP) sounds. As the circuit oscillates, the relay's (S3) contacts open and close shorting the motor and speaker to ground. See how much you can adjust the adjustable resistor before the motor turns off or continuously spins.

Project #631 Stepper Motor w/ Light

OBJECTIVE: To add light to a stepper motor circuit.

Modify project #630 by removing the speaker (SP) and replacing it with the lamp (L1). Now when you turn the slide switch (S1) on, the lamp lights as the motor spins.

WARNING: Moving parts. Do not touch the fan or motor during operation.

Project #632

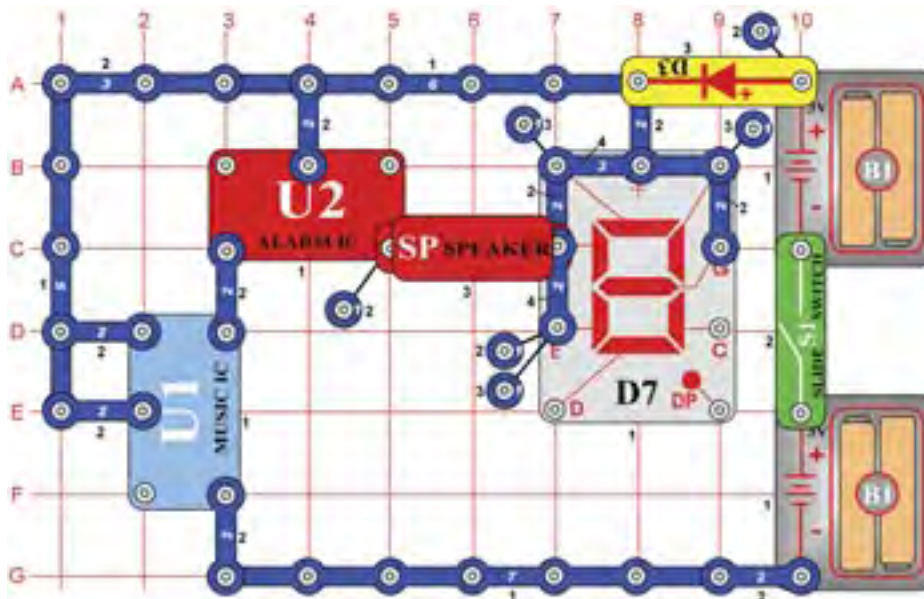

Police Siren with Display

OBJECTIVE: To display the letter "P" as the alarm IC sounds.

Turn the slide switch (S1) on and the speaker (SP) sounds as the letter "P" lights. You also hear the music IC (U1) playing in the background. The alarm IC (U2) plays as long as the music IC is on since U2 is connected to U1's output. After 20 seconds, the circuit turns off for 5 seconds and then starts again.

Project #633

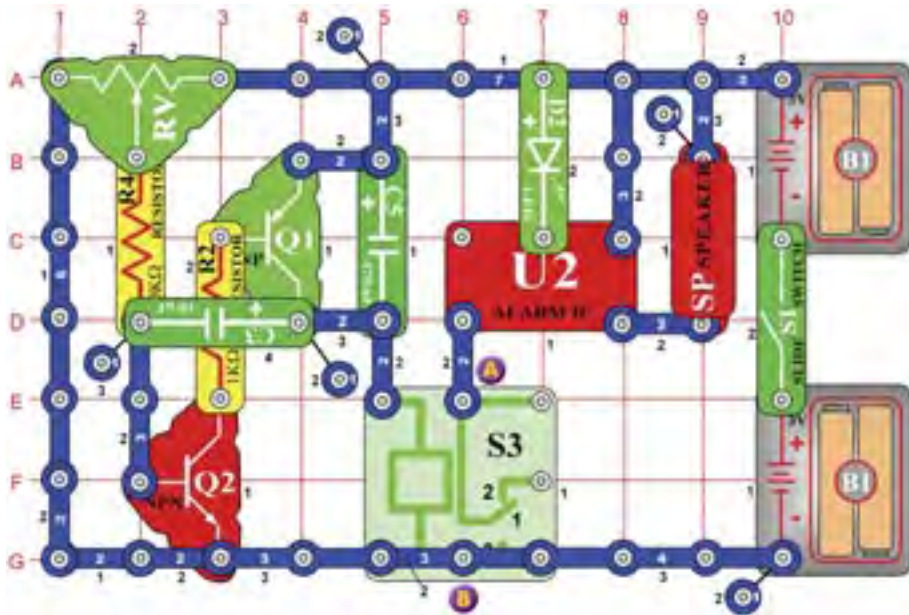

Oscillator Alarm

OBJECTIVE: To control the alarm IC with an oscillator circuit.

Set the adjustable resistor (RV) to the far left and turn the slide switch (S1) on. The speaker (SP) sounds only once. Slowly move the adjustable resistor to the right, the speaker momentarily sounds. As you move the adjustable resistor to the right, the alarm is on continuously. The adjustable resistor controls the frequency of the oscillator circuit (C3, C5, Q1, Q2) by adjusting the voltage at Q2's base. The relay (S3) switches the alarm IC (U2) on and off.

Project #634 Oscillator Alarm (II)

OBJECTIVE: To control the alarm IC with an oscillator circuit.

Using a single snap, connect the red LED (D1, "+" side on point A) across points A & B. Turn the slide switch (S1) on and the circuit has a different sound now.

Project #635

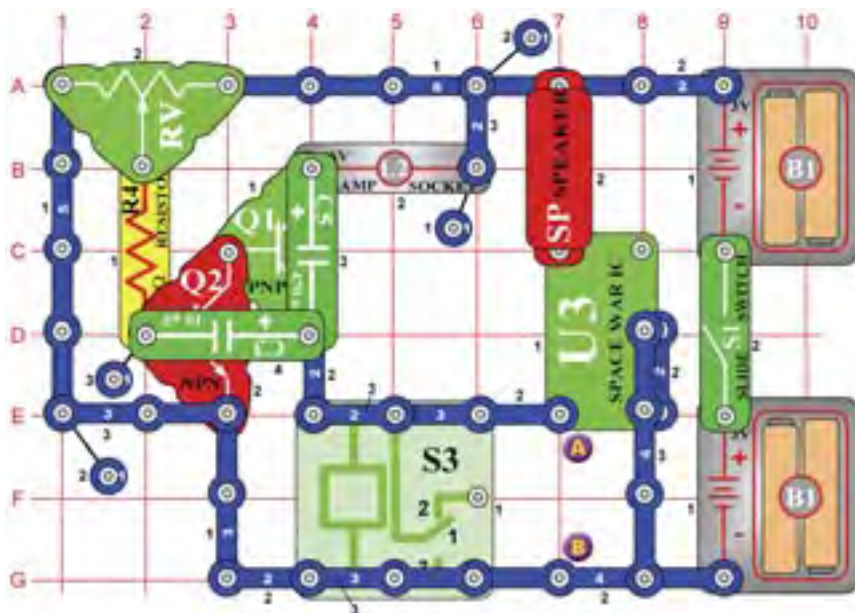

Tapping U3

OBJECTIVE: To control the space war IC with an oscillator circuit.

Set the adjustable resistor (RV) to the middle position and turn the slide switch (S1) on. This is another example using the oscillator that switches the power on and off creating sound. Alter the sound by adjusting the adjustable resistor.

Project #636 Tapping U3 (II)

OBJECTIVE: To control the space war IC with an oscillator circuit.

Connect the motor (M1) across points A & B. Set the adjustable resistor (RV) to the middle position and turn the slide switch (S1) on. Now you hear random noise and static from the speaker (SP). The motor causes the random static and noise from the speaker.

Project #637

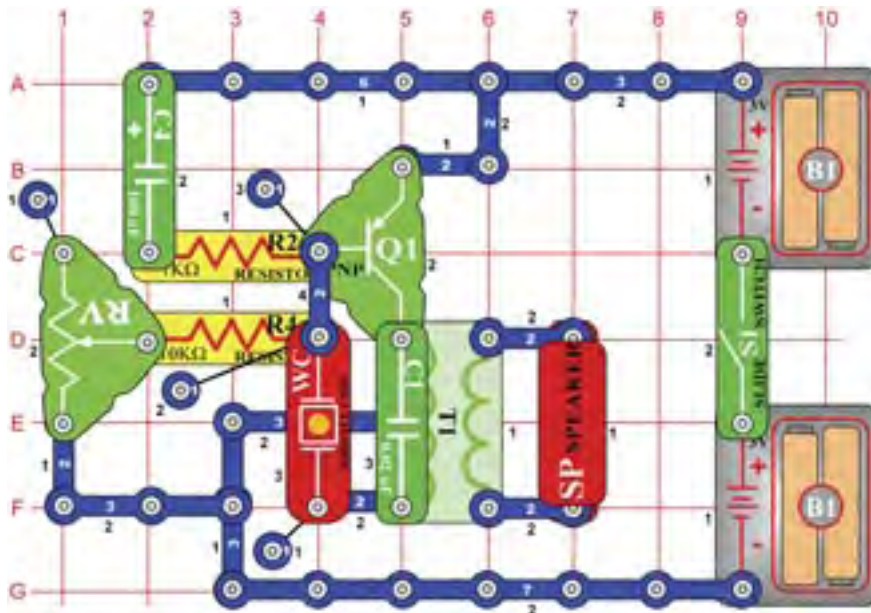

Adjustable Beeper

OBJECTIVE: To build a simple oscillator that beeps.

Turn the slide switch (S1) on and this simple oscillator circuit outputs a beep from the speaker (SP). Change the frequency by adjusting the adjustable resistor (RV).

Project #638

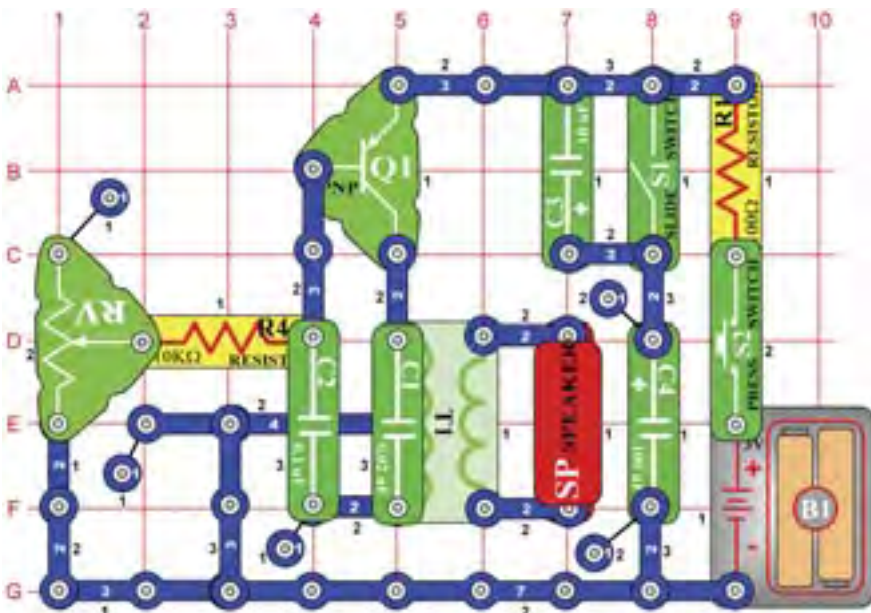

Electronic Meow

OBJECTIVE: To create the sound of a cat's meow.

Turn off the slide switch (S1) and then press and release the press switch (S2). You hear a "cat's meow" from the speaker (SP). Now turn the slide switch (S1) on and the sound is lower and lasts longer. Adjust the adjustable resistor (RV) while the sound is fading away.

Project #639 Electronic Meow (II)

OBJECTIVE: To add the photoresistor to project #638.

Replace the 10KΩ resistor (R4) with the photoresistor (RP). Wave your hand over photoresistor as you press down on the press switch (S2).

Project #640

Strobe Light

OBJECTIVE: To construct an LED strobe light.

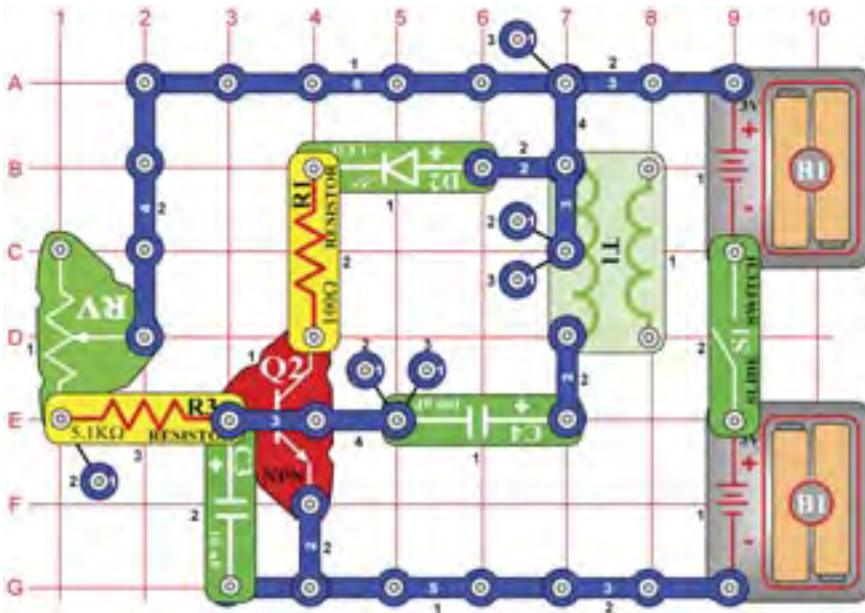

This is an example of how a large strobe light works. Turn the slide switch (S1) on and the LED (D2) flashes at a certain frequency. Adjust the frequency by adjusting the adjustable resistor (RV). Now add sound by replacing the 100Ω resistor (R1) with the speaker (SP). Each time the LED lights, the speaker sounds.

Project #641

AND Gate

OBJECTIVE: To demonstrate the operations of the AND gate.

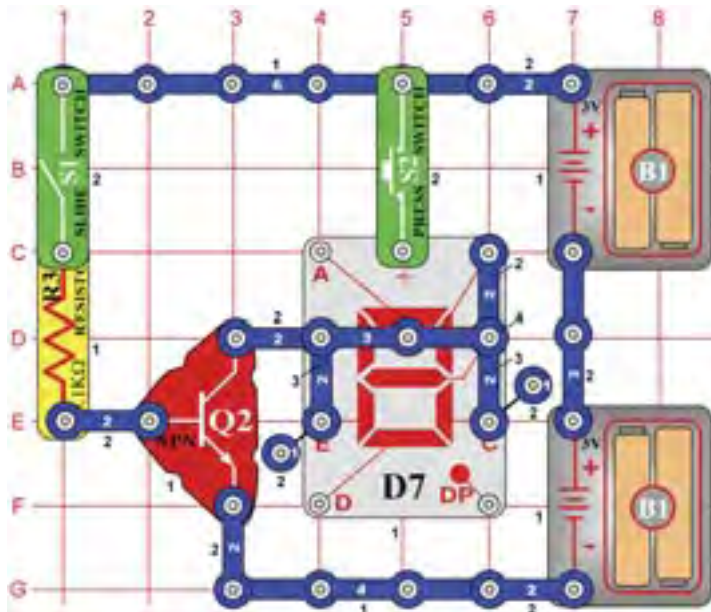

In digital electronics, there are two states, 0 & 1. The **AND gate** performs a logical “and” operation on two inputs, A & B. If A **AND** B are both 1, then Q should be 1. The logic table below shows the state of “Q” with different inputs and the symbol for it in circuit diagrams.

A	B	Q	D7
0	0	0	—
1	0	0	—
0	1	0	—
1	1	1	“H”

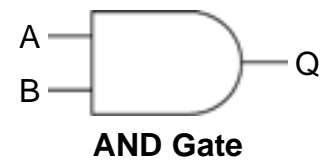

Turn the slide switch (S1) on and the display (D7) does not light. Turn S1 off and then press the press switch (S2) and still the display does not light. Turn S1 on and press the press switch down. Now, the LED and the letter “H” light.

Project #642

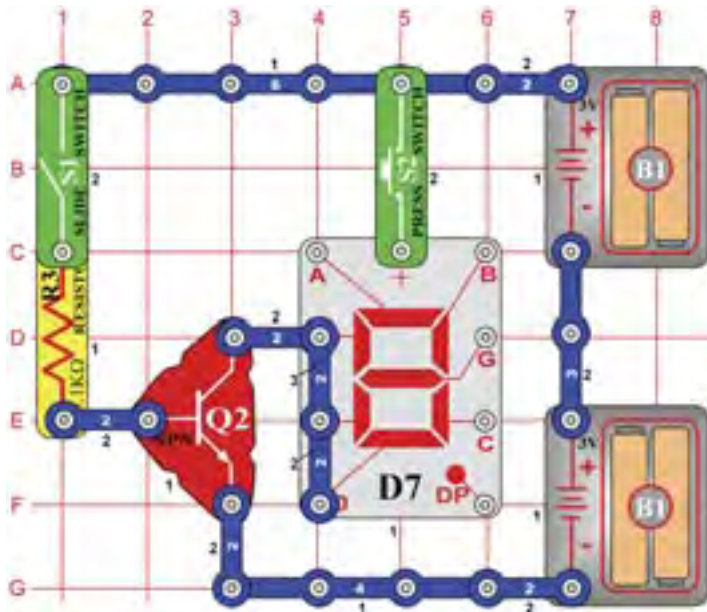

NAND Gate

OBJECTIVE: To demonstrate the operations of the NAND gate.

The NAND gate works the opposite of the AND as shown in the logic chart.

A	B	Q	D7
0	0	1	—
1	0	1	—
0	1	1	—
1	1	0	“L”

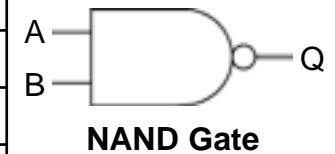

Using the chart set the switches (S1 & S2) to the different states. When you have logic “0” the display (D7) lights the letter “L”.

Project #643

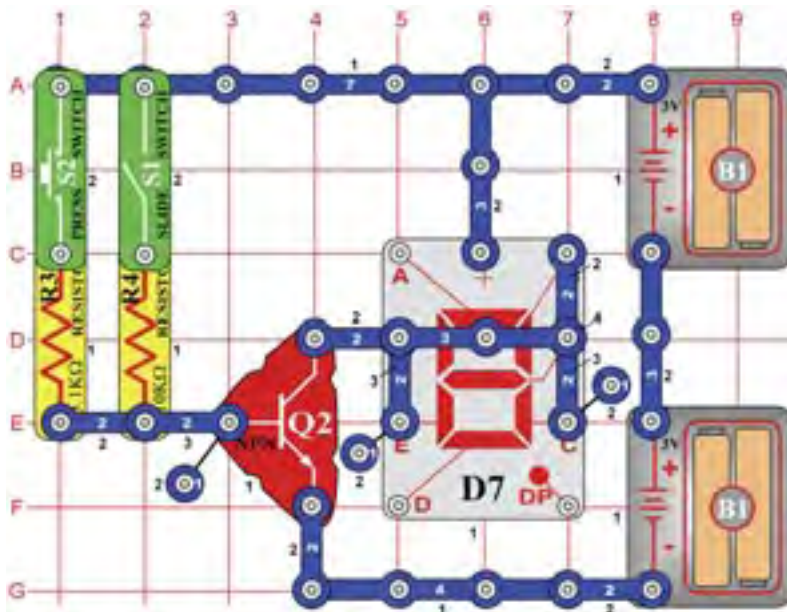

OR Gate

OBJECTIVE: To demonstrate the operations of the OR gate.

The basic idea of an OR gate is: If A OR B is 1 (or both are 1), then Q is 1.

A	B	Q	D7
0	0	0	—
1	0	1	“H”
0	1	1	“H”
1	1	1	“H”

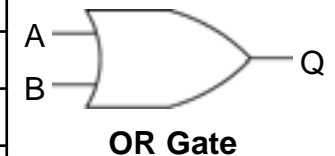

Using the chart, set the switches (S1 & S2) to the different states. Only when you have logic “0” the display (D7) does not light the “H”.

Project #644

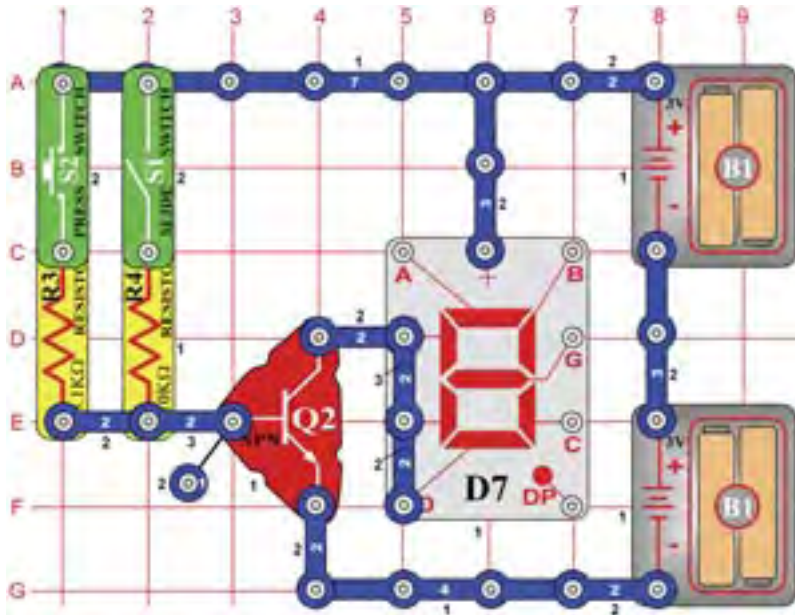

NOR Gate

OBJECTIVE: To demonstrate the operations of the NOR gate.

The NOR gate works the opposite of the OR. Using the chart, set the switches (S1 & S2) to the different states. The display (D7) lights the letter "L" when either switch is turned on.

A	B	Q	D7
0	0	1	—
1	0	0	"L"
0	1	0	"L"
1	1	0	"L"

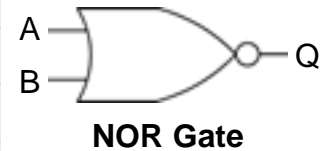

Project #645

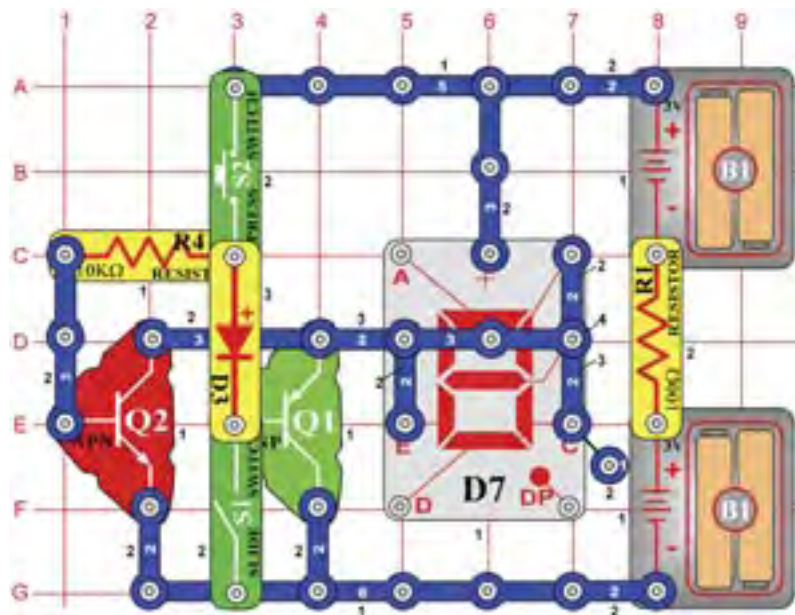

XOR Gate

OBJECTIVE: To demonstrate the operations of the "exclusive or" XOR gate.

In an XOR gate the output "Q" is only high when inputs "A" or "B" is set high (1).

Using the chart, set the switches (S1 & S2) to the different states. The display (D7) lights the letter "H" only when either switch is turned on.

A	B	Q	D7
0	0	0	—
1	0	1	"H"
0	1	1	"H"
1	1	0	—



Project #646

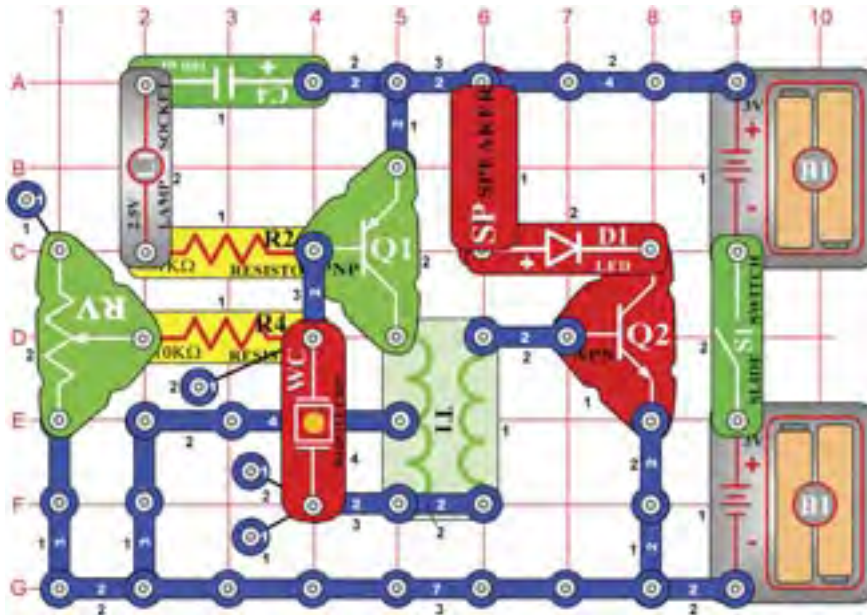

High Pitch Oscillator

OBJECTIVE: *To build a high pitch oscillator.*

Set the adjustable resistor (RV) to the top position and then turn the slide switch (S1) on. You hear a high pitch sound and the LED (D1) flashes at the same rate. Change the oscillator frequency by adjusting RV.

Project #647 Low Pitch Oscillator

OBJECTIVE: *To modify project #646.*

Replace the whistle chip (WC) with the 0.1µF capacitor (C2). Turn the slide switch (S1) on and now the circuit oscillates at a lower frequency.

Project #648 Low Pitch Oscillator (II)

OBJECTIVE: *To modify project #646.*

Replace the 0.1µF capacitor (C2) with the 10µF capacitor (C3) placing the "+" sign towards the top. Turn the slide switch (S1) on; now the circuit oscillates at a lower frequency.

Project #649 Low Pitch Oscillator (III)

OBJECTIVE: *To modify project #646.*

Replace the 10µF capacitor (C3) with the 470µF capacitor (C5) placing the "+" sign towards the top. Turn the slide switch (S1) on and the circuit oscillates at a lower frequency now.

Project #650

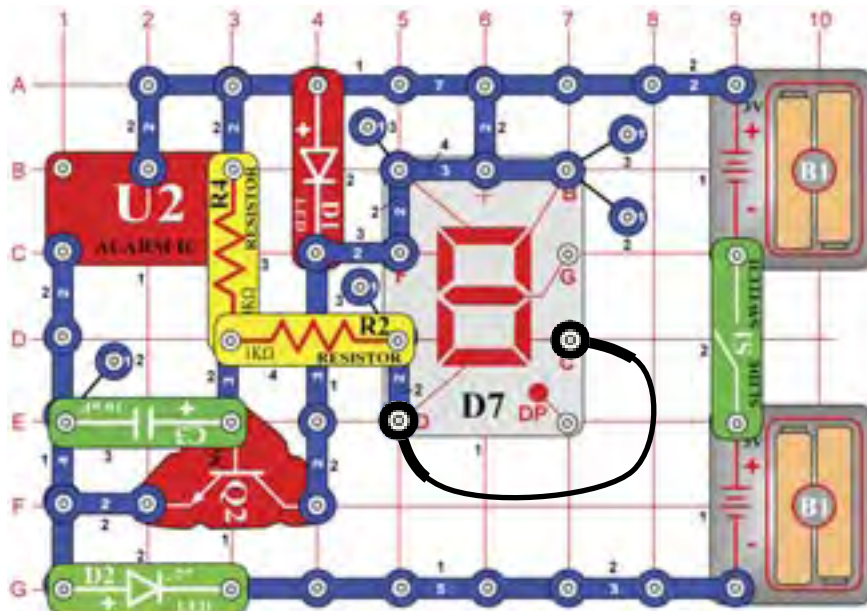

Segment Jumper

OBJECTIVE: To use the alarm IC with the 7-segment display.

Turn the slide switch (S1) on; segments A, B, and F light and then segments C, D, and E. The two groups of segments are connected to different voltages. As the voltage changes from high to low, the segments toggle back and forth.

Project #651

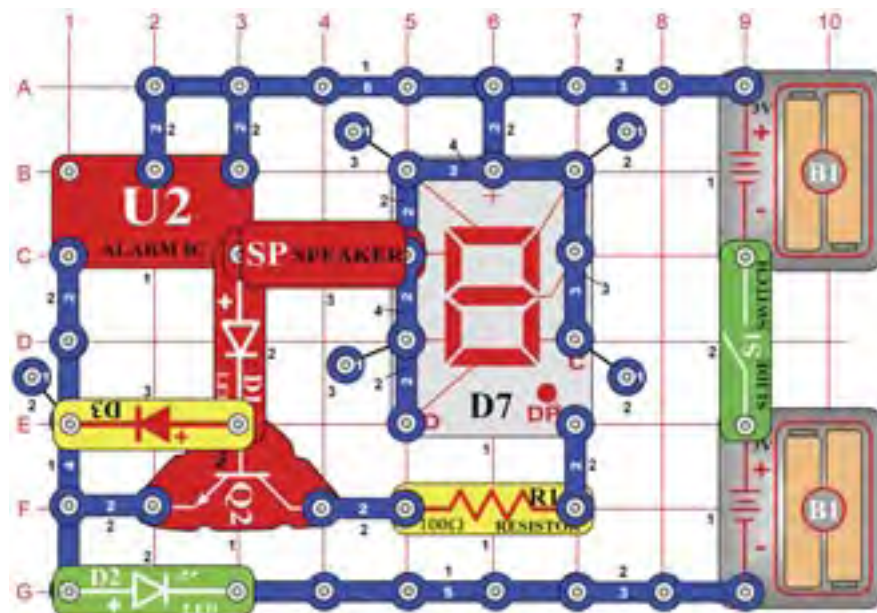

DP & Zero Flasher

OBJECTIVE: To use the alarm IC with the 7-segment display.

As in project #650, we use the alarm IC (U2) to flash segments and LED's. Turn the slide switch (S1) on and the number "0" and the green LED (D2) flash as the speaker (SP) sounds. When they turn off, the DP segment lights.

Project #652

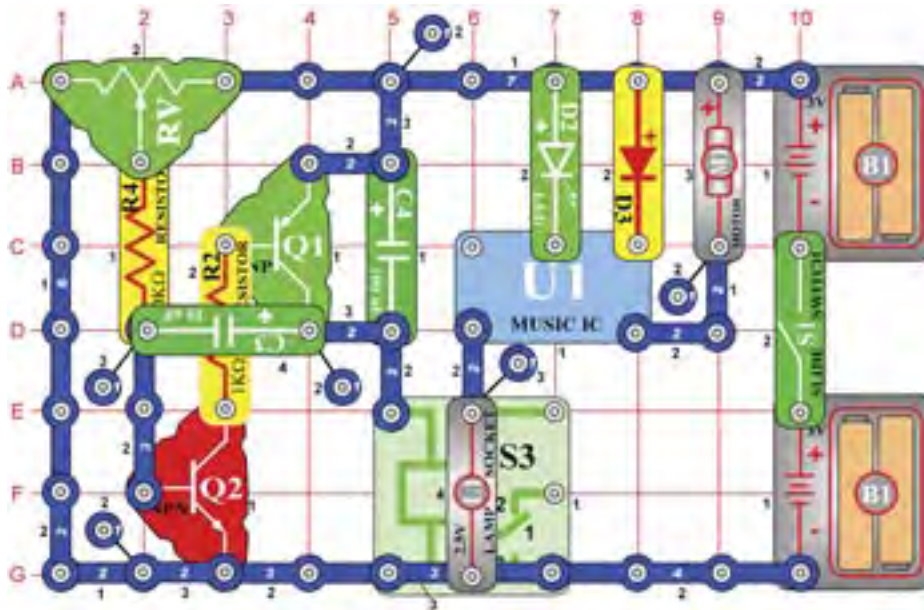

Stepper Motor with Lamp & LED's

OBJECTIVE: To add LED's to a stepper motor circuit.

The circuit works the same as project #631 except now the green LED (D2) lights when the motor (M1) and bulb (L1) are off. Set the adjustable resistor (RV) to the middle position. Turn the slide switch (S1) on, the motor spins, the bulb lights, and then turn off as the green LED lights. Even though the motor is connected to the LED, it will not spin because the series resistor limits the current.

Project #653

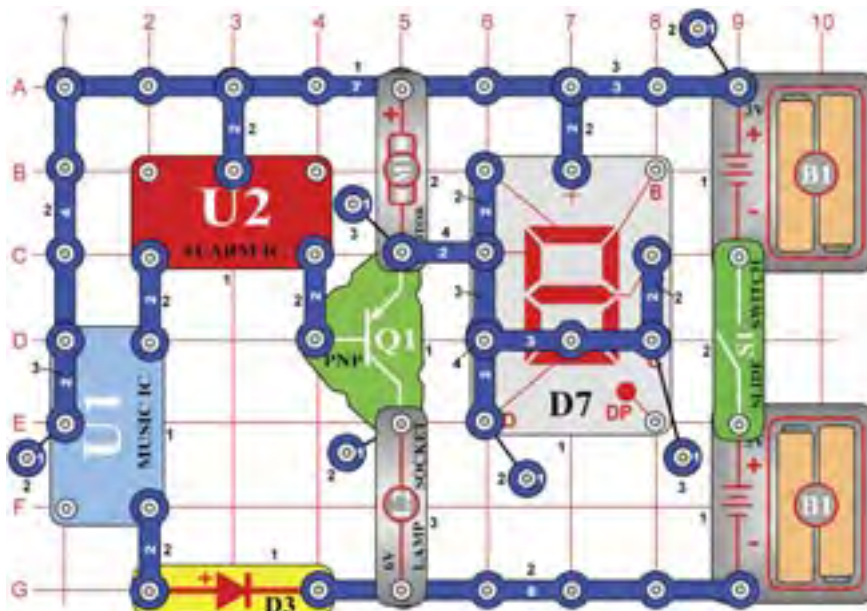

IC Start & Stop

OBJECTIVE: To drive the motor and display with two IC modules.

Turn the slide switch (S1) on. As the output from the IC (U2) drives the transistor (Q1), the motor (M1) spins and the display (D7) lights the letter "S" and then turns off.



WARNING: Moving parts. Do not touch the fan or motor during operation.

Project #654



OBJECTIVE: To modify project #653 so the motor slows down.

Turn the slide switch (S1) on. As the output from the IC (U2) drives the transistor (Q1), the motor (M1) spins and the display (D7) lights. Instead of turning off as in project #653, the motor slows down and the red LED (D1) lights.

Modify the circuit by placing a jumper wire across points A & B. Now the circuit pulses and then runs continuously for a short time.

WARNING: Moving parts. Do not touch the fan or motor during operation.

Project #655

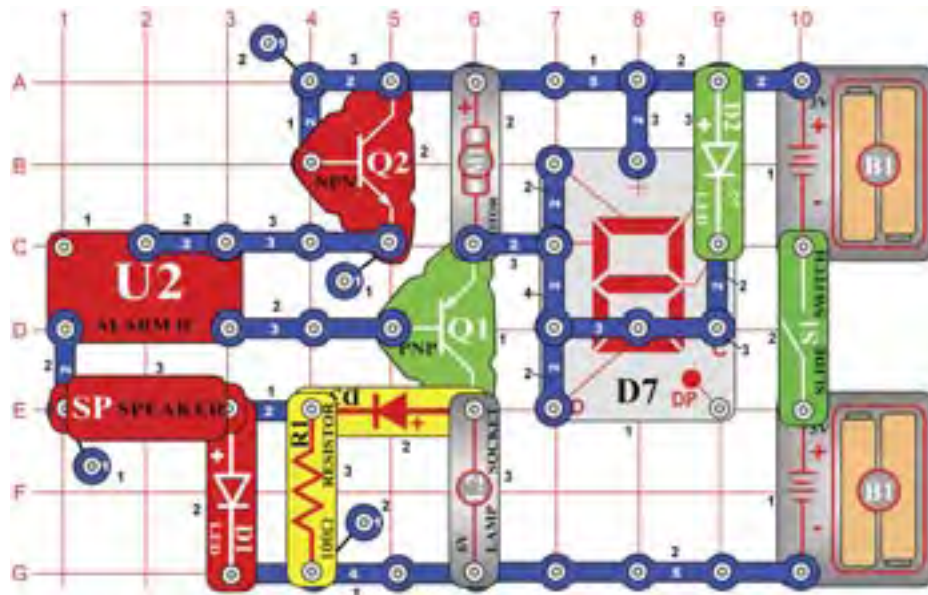

OBJECTIVE: To use the alarm IC to drive the motor, speaker, LED and bulb.

Turn the slide switch (S1) on and the speaker (SP) outputs the sounds from the alarm IC (U2). The IC also drives the transistor (Q1) causing the motor (M1) to spin and lights to flash.

WARNING: Moving parts. Do not touch the fan or motor during operation.

Project #656

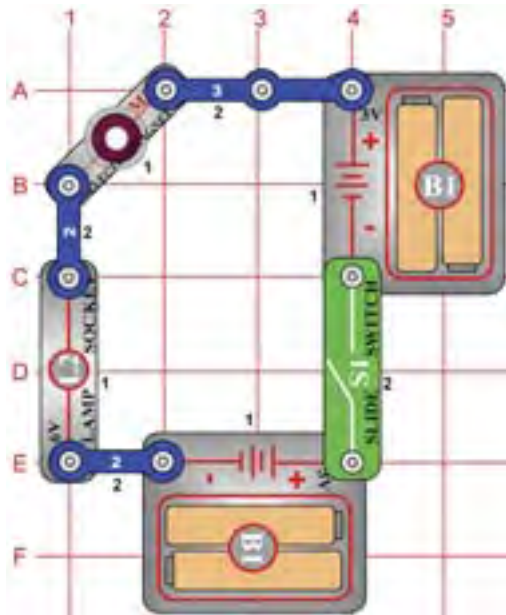

Electromagnet Delayer

OBJECTIVE: *To learn about the electromagnet.*

Build the circuit and turn it on. After a delay of about 2 seconds, the lamp (L2) will light, but be dim. Replace your batteries if it does not light at all.

Why does the electromagnet (M3) delay the lamp turn-on? The electromagnet (M3) contains a large coil of wire, and the batteries have to fill the coil with electricity before the lamp can turn on. This is like using a long hose to water your garden - when you turn on the water it takes a few seconds before water comes out the other end.

Once the lamp is on, the resistance of the wire in the coil keeps the lamp from getting bright. You can replace the 6V lamp with the 2.5V lamp (L1), because the coil will protect it from the full battery voltage.

Project #657

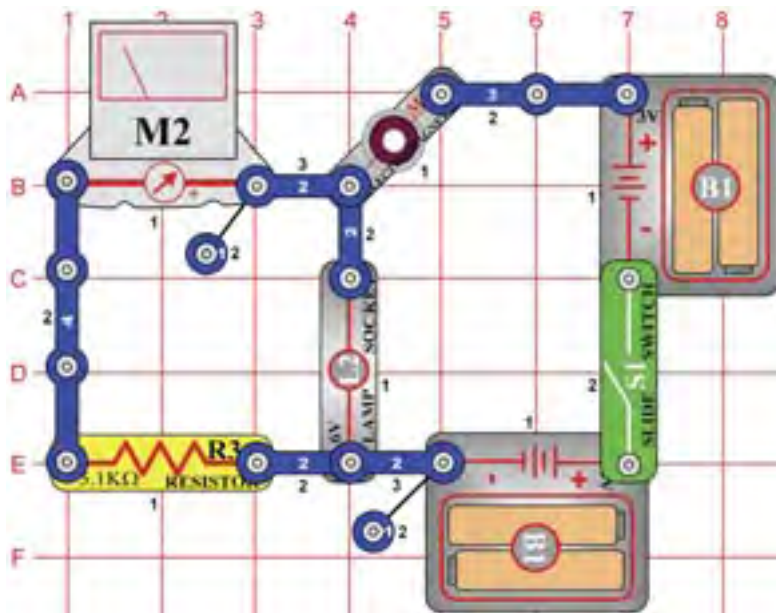

Electromagnet Delayer (II)

OBJECTIVE: *To learn about the electromagnet.*

Use the LOW (or 10mA) setting on the meter (M2) and turn on the slide switch (S1). The meter shows how the current slowly rises. After a delay of about 2 seconds, the lamp (L2) will light but be dim.

Project #658

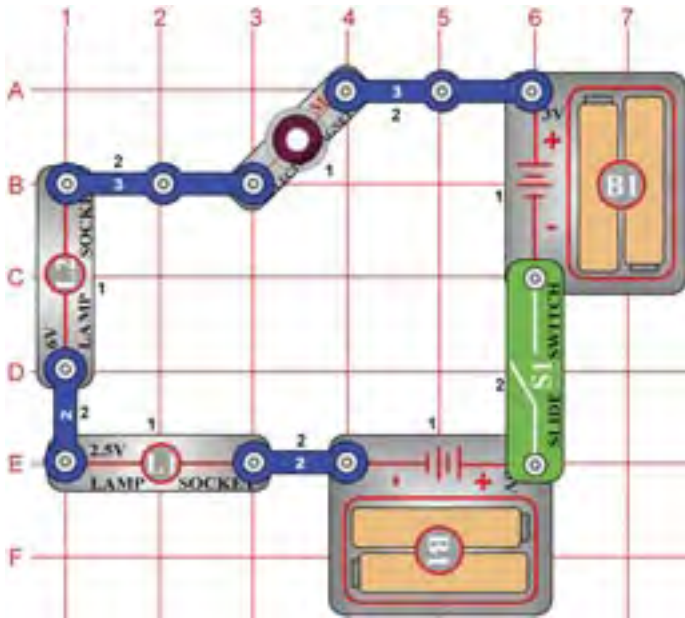

Two-Lamp Electromagnet Delayer

OBJECTIVE: *To learn about the electromagnet.*

Build the circuit and turn it on. First the 2.5V lamp (L1) turns on, and then the 6V lamp (L2) turns on. Both may be dim, replace your batteries if they do not light at all.

The electromagnet (M3) stores energy, and the batteries must fill it up before the lamps become bright. The smaller bulb turns on sooner because it needs less current to light.

Project #659

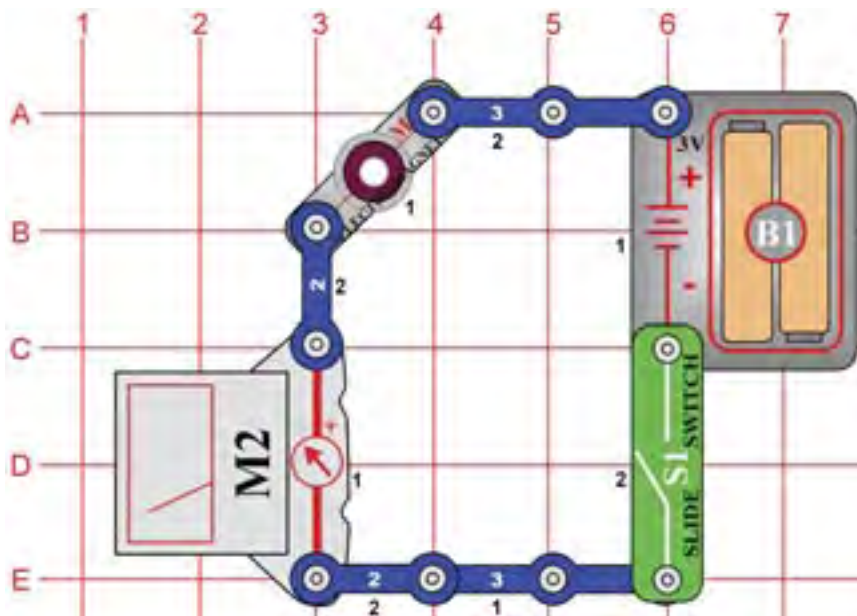

Electromagnet Current

OBJECTIVE: *To measure the electromagnet current.*

Use the HIGH (or 1A) setting on the meter (M2) to measure the electromagnet (M3) current. Compare the meter reading to that for the motor and lamp current in projects #544-546. Insert the iron core rod into the electromagnet and see if it changes the meter reading.



Project #660

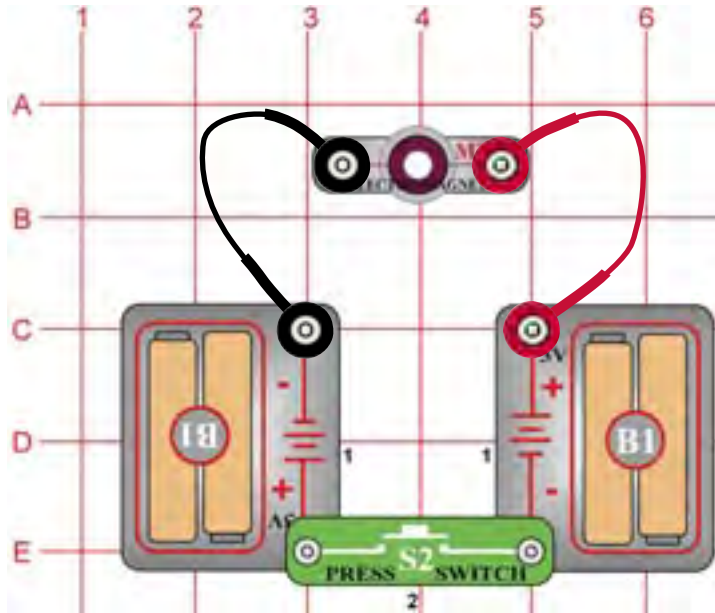

Electromagnetism

OBJECTIVE: *To learn how electricity and magnetism are related.*

Put the iron core rod into the electromagnet (M3). Press the press switch (S2) and place the electromagnet (M3) near some iron objects like a refrigerator or a hammer, it will be attracted to them. You can use it to pick up iron objects, such as nails.

Electricity and magnetism are closely related, and an electric current flowing in a coil of wire has a magnetic field just like a normal magnet. Placing an iron rod through the coil magnifies this magnetic field. Notice that when the electromagnet is attracted to an iron object, its attraction is strongest at the ends of the iron core rod. If you remove the iron core rod from the electromagnet then its magnetic properties are greatly reduced – try this:

If you place the electromagnet upside down under a large object like a table, you can suspend it there. Be careful though, since it will fall when you release the press switch.

You can use this circuit to see which things are made of iron. Other metals like copper or aluminum will not be attracted to the electromagnet.



Project #661



Compass

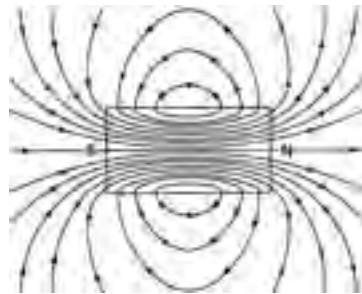

Magnetic Field

Electromagnetism & Compass

OBJECTIVE: *To learn how electricity and magnetism are related.*

You need a compass for this project (not included). Use the circuit from project #660, with the iron core rod in the electromagnet (M3). You may want to use the slide switch (S1) in place of the press switch (S2), but only turn it on as needed or you will quickly drain your batteries.

Turn on the slide switch and move the compass around near the edges of the electromagnet, it will point toward ends of the iron core rod. By slowly moving the compass around the electromagnet, you can see the flow of its magnetic field.

The earth has a similar magnetic field, due to its iron core. A compass points north because it is attracted to this magnetic field. The electromagnet creates its own magnetic field, and attracts the compass in a similar way.

□ Project #662 Electromagnetism & Paperclips

OBJECTIVE: *To learn how electricity and magnetism are related.*

Use the circuit from project #660, with the iron core rod in the electromagnet (M3). Press the press switch (S2) and use the electromagnet to pick up some paperclips, they will be attracted to both ends of the iron core rod. See how many paperclips you can lift at once.

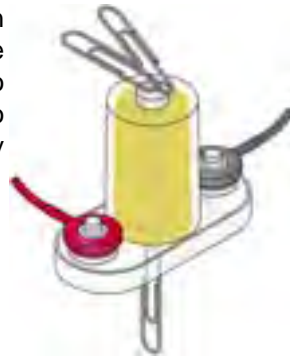

You can also use the paperclip to lift the iron core rod up from the electromagnet.



Snap two 2-snaps around a paperclip and lift them with the electromagnet, as shown here on the left.

See what other small objects you can pick up. You can only pick up things made of iron, not just any metal.

The magnetic field created by the electromagnet occurs in a loop, and is strongest in the iron core rod in the middle. You can see this loop with some paperclips:

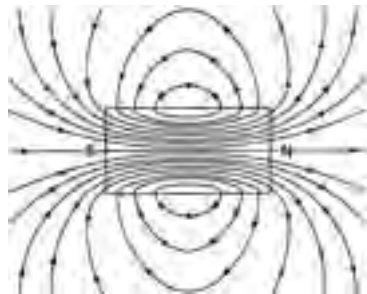

□ Project #663 Electromagnet Suction

OBJECTIVE: *To show how electricity can lift things using magnetism.*



An electric current flowing in a coil of wire has a magnetic field, which tries to suck iron objects into its center. You can see this using the circuit from project #660.

Lay the electromagnet (M3) on its side with the iron core rod sticking out about half way, and press the press switch (S2). The iron rod gets sucked into the center.

A lighter iron object will show this better. Take a paperclip and straighten it out, then bend it in half.

Place the bent paperclip next to the electromagnet and turn on the switch to see it get sucked in. Gently pull it out to feel how much suction the electromagnet has.

Try sucking up other thin iron objects, like nails.

Project #664

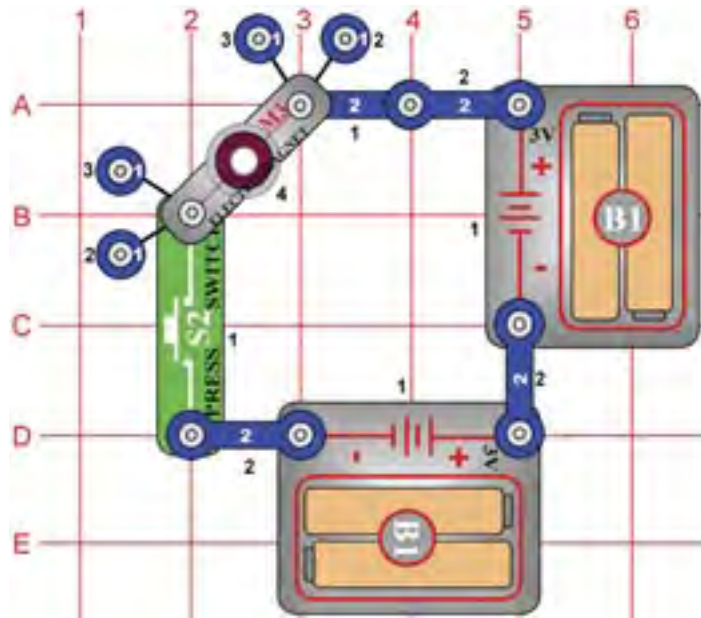

Electromagnet Tower

OBJECTIVE: *To show how electricity can lift things using magnetism.*

This circuit gives a dramatic demonstration of how the electromagnet (M3) can suck up a paperclip. Take a paperclip and straighten it out, then bend it in half. Drop it into the electromagnet center, and then press the press switch (S2) several times. The paperclip gets sucked into the center of the electromagnet and stays suspended there until you release the press switch.

Add two more 1-snaps under the electromagnet to make it higher, and try this again. Then try sucking up other thin iron objects, like nails.

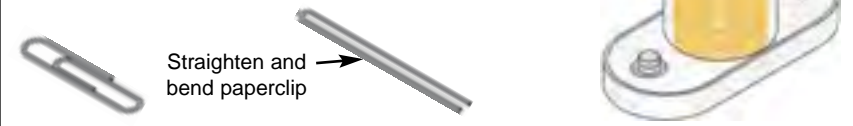

Project #665

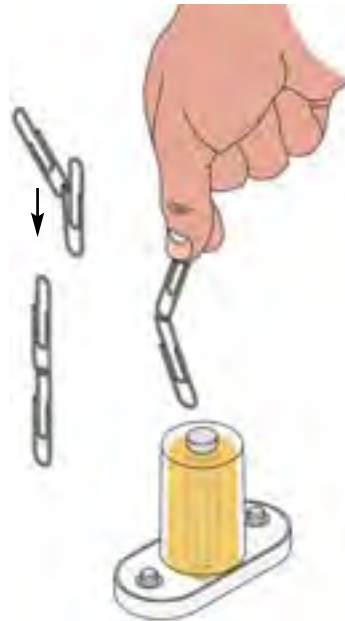

Paperclip Compass

OBJECTIVE: *To learn how electricity and magnetism are related.*

Use the circuit from project #664, but place the iron core rod in the electromagnet (M3). You may want to use the slide switch (S1) in place of the press switch (S2), but only turn it on as needed or you will quickly drain your batteries.

Slide two paperclips together, using their loops.

Turn on the switch and hold the paperclips just above the electromagnet, without them touching the iron core rod. Watch how the lower paperclip is drawn toward the iron core rod, and will point towards it just like a compass.

Project #666

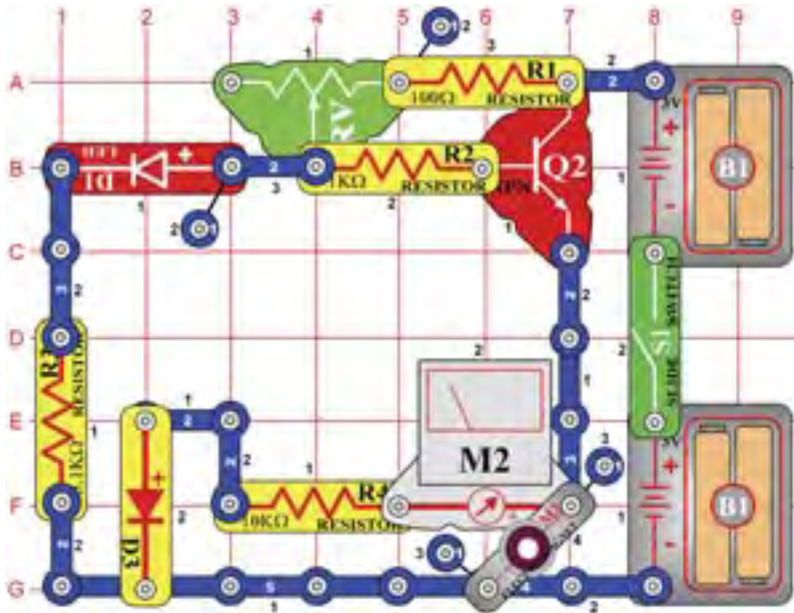

Adjustable Paperclip Suspension

OBJECTIVE: To show how electricity can lift things using magnetism.

Use the LOW (or 10mA) setting on the meter (M2). Take a paperclip and straighten it out, bend it in half, and drop it into the electromagnet (M3) center. Turn on the slide switch (S1) and set the adjustable resistor (RV) control lever all the way to the right. The paperclip gets sucked into the center of the electromagnet and stays suspended there.

Now very slowly move the adjustable resistor lever to the left, and watch the paperclip and the meter reading. The paperclip slowly gets lower, as the meter shows the current dropping. When the current is at zero, the paperclip is resting on the table.

Add two more 1-snaps under the electromagnet to make it higher, and try this again. Or try using a different iron object in place of the paperclip.

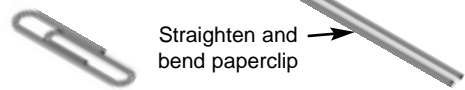
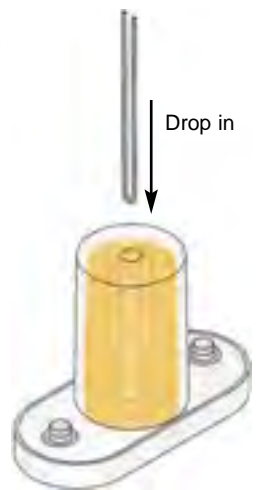

Project #667

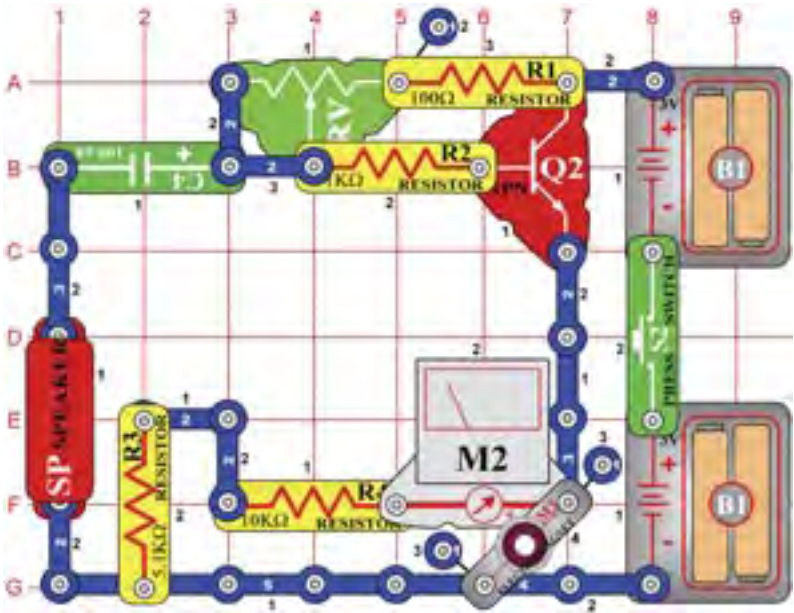

Adjustable Paperclip w/ Delay

OBJECTIVE: To show how electricity can lift things using magnetism.

Use the LOW (or 10mA) setting on the meter (M2). Take a paperclip and straighten it out, bend it in half, and place it into the electromagnet (M3) center. Turn on the press switch (S2) and set the adjustable resistor (RV) control lever all the way to the right. The paperclip gets sucked into the center of the electromagnet and stays suspended there.

Now quickly slide the adjustable resistor lever all the way to the left, and watch the paperclip and the meter reading. The paperclip slowly gets lower, as the meter shows the current dropping. This circuit is similar to project #666, but the capacitor delays the effect of changing the adjustable resistor setting.

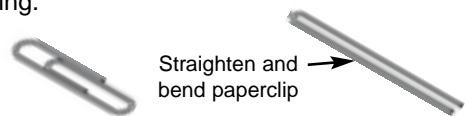
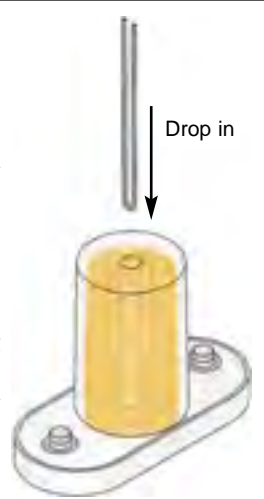

Project #668

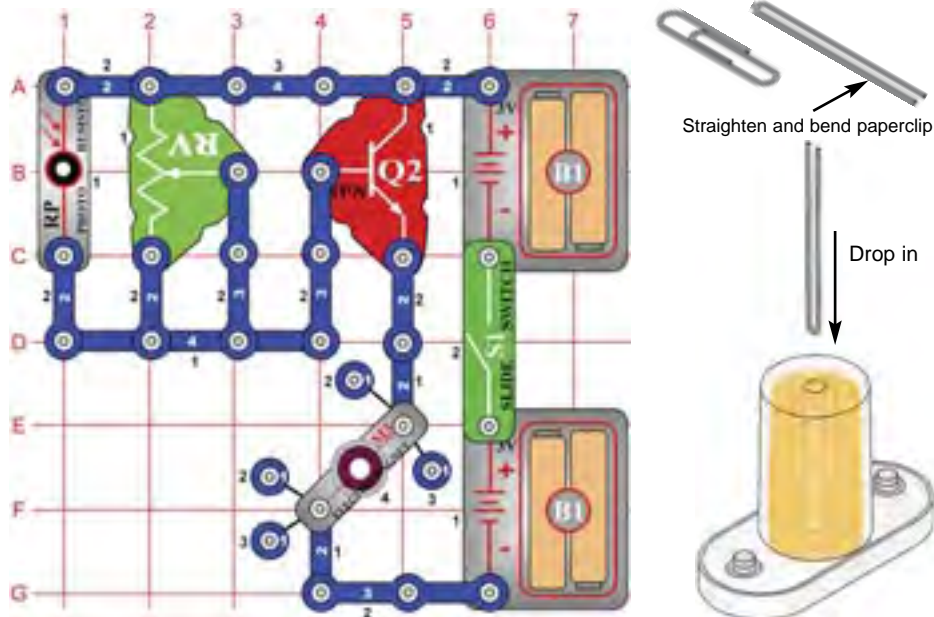

Photoresistor Paperclip Suspension

OBJECTIVE: To show how electricity can lift things using magnetism.

Take a paperclip and straighten it out, bend it in half, and place it into the electromagnet (M3) center. Turn on the slide switch (S1), the paperclip gets sucked into the center of the electromagnet and stays suspended there.

Now move the adjustable resistor (RV) control lever around while waving your hand over the photoresistor (RP). Depending on the adjustable resistor setting, sometimes covering the photoresistor causes the paperclip to fall and sometimes it doesn't. You can also adjust the light to set the paperclip to different heights.

Project #669

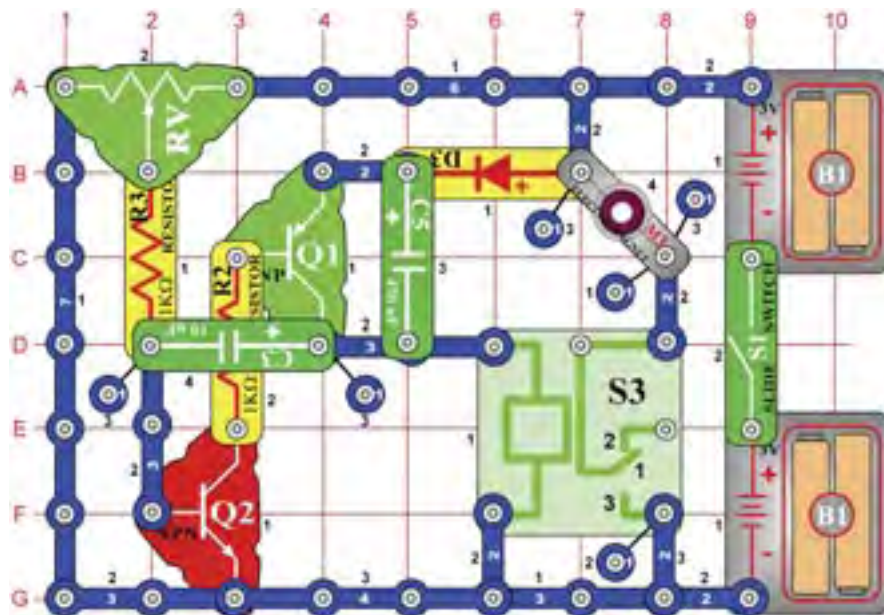

Paperclip Oscillator

OBJECTIVE: To show how electricity can lift things using magnetism.

Take a paperclip and straighten it out, bend it in half, and place it into the electromagnet (M3) center. Turn on the slide switch (S1), and set the adjustable resistor (RV) control lever to the right. The paperclip gets sucked into the center of the electromagnet and stays suspended there. Move the adjustable resistor lever to the left, and the paperclip falls.

Now for the fun part: Slowly slide the adjustable resistor lever until you find a spot where the paperclip is bouncing up and down. There will be a clicking sound from the relay (S3).

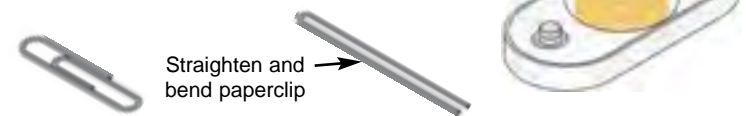

Project #670

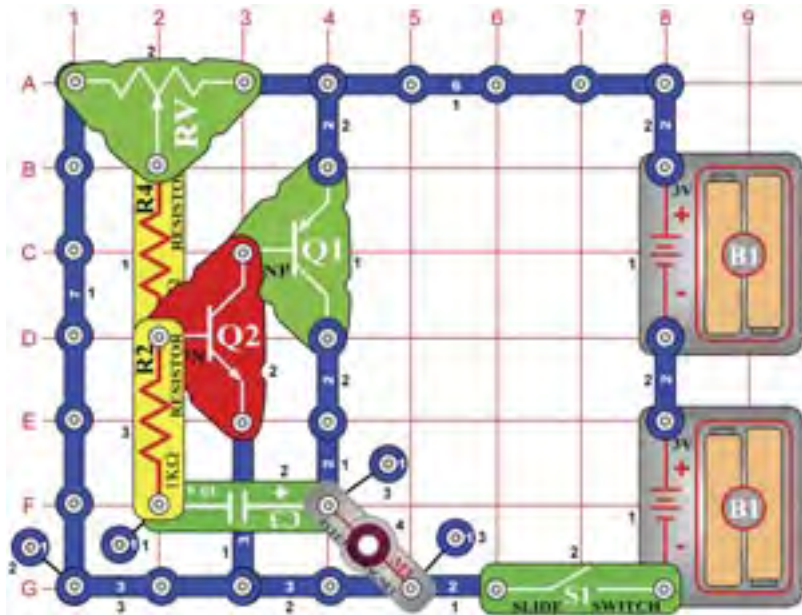

Paperclip Oscillator

OBJECTIVE: To show how electricity can lift things using magnetism.

Take a paperclip and straighten it out, bend it in half, and place it into the electromagnet (M3) center. Turn on the slide switch (S1), and set the adjustable resistor (RV) control lever to the right. The paperclip gets sucked into the center of the electromagnet and stays suspended there. Move the adjustable resistor lever to the left, and the paperclip falls.

Now for the fun part: Slowly slide the adjustable resistor lever until you find a spot where the paperclip is bouncing up and down.

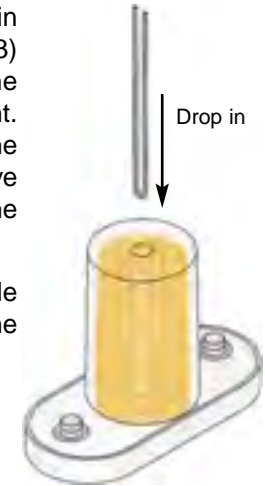
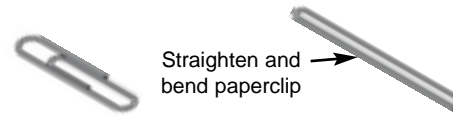

Project #671

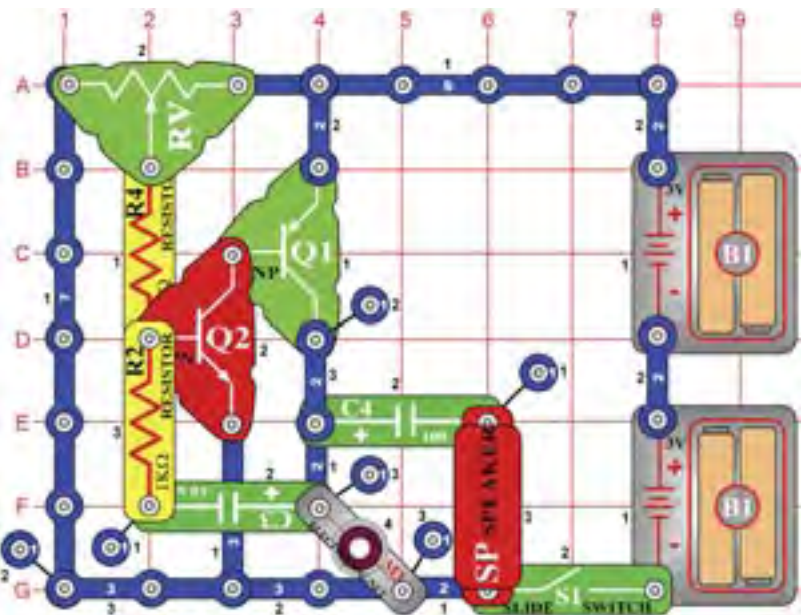

Paperclip Oscillator (III)

OBJECTIVE: To show how electricity can lift things using magnetism.

Take a paperclip and straighten it out, bend it in half, and place it into the electromagnet (M3) center. Turn on the slide switch (S1), and set the adjustable resistor (RV) control lever to the right. The paperclip gets sucked into the center of the electromagnet and stays suspended there. Move the adjustable resistor lever to the left, and the paperclip falls.

Now for the fun part: Slowly slide the adjustable resistor lever until you find a spot where the paperclip is bouncing up and down. The speaker (SP) makes a clicking sound.

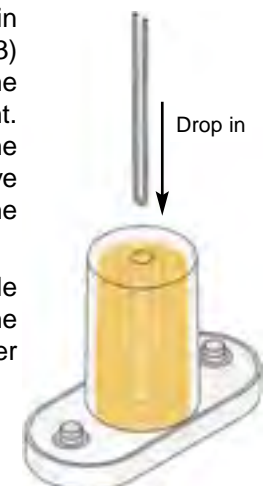
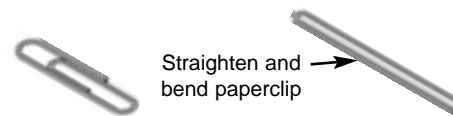

Project #672

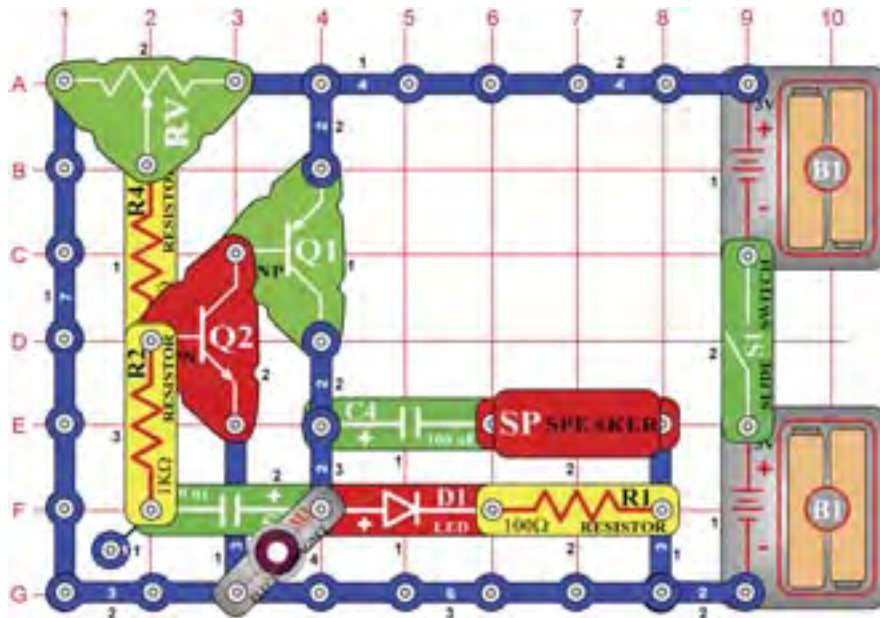

Paperclip Oscillator (IV)

OBJECTIVE: To show how electricity can lift things using magnetism.

Take a paperclip and straighten it out, bend it in half, and place it into the electromagnet (M3) center. Turn on the slide switch (S1), and set the adjustable resistor (RV) control lever to the right. The paperclip gets sucked into the center of the electromagnet and stays suspended there. Move the adjustable resistor lever to the left, and the paperclip falls.

Now for the fun part: slowly slide the adjustable resistor lever until you find a spot where the paperclip is bouncing up and down. The LED (D1) flashes and the speaker (SP) makes a clicking sound.



Straighten and bend paperclip

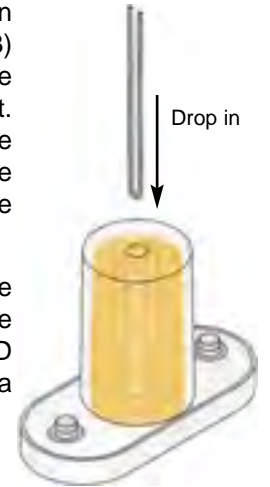

Project #673 Paperclip Oscillator (V)

OBJECTIVE: To show how electricity can lift things using magnetism.

Use the circuit from project #672, but replace the 100 μ F capacitor (C4) with a 3-snap wire and replace the speaker (SP) with the 6V lamp (L2). The circuit works the same way, but the lamp flashes like a strobe light.

Project #674

OBJECTIVE: To learn how electricity and magnetism are related.



Oscillating Compass

Use the circuit from project #672, but replace the 100 μ F capacitor (C4) with a 3-snap wire and replace the speaker (SP) with the 6V lamp (L2). Place the iron core rod in the electromagnet (M3) and don't use the bent paperclip. Slide two paperclips together, using their loops.

Turn on the slide switch (S1) and hold the paperclips just above the electromagnet, without them touching the iron core rod. Watch how the lower paperclip is drawn toward the iron core rod. Notice that the lower paperclip is vibrating, due to the changing magnetic field from this oscillator circuit. Compare this circuit to project #665 (Paperclip Compass).

Project #675

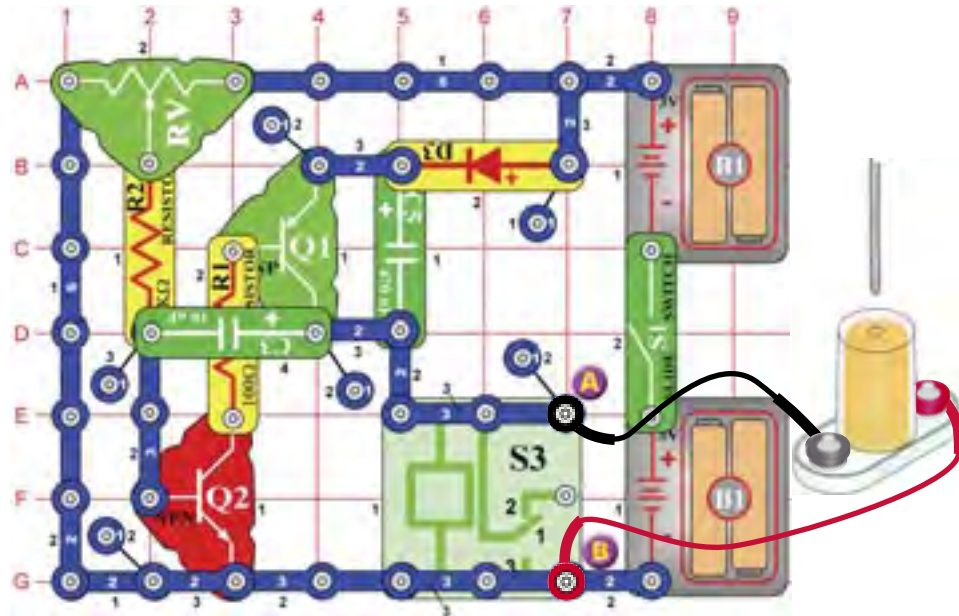

High Frequency Vibrator

OBJECTIVE: *To show how electricity can lift things using magnetism.*

Take a paperclip and straighten it out, bend it in half, and place it into the electromagnet (M3) center. Connect the electromagnet to points A & B with the jumper wires and hold it about 1 inch above the table. Slide the adjustable resistor (RV) control lever around slowly, you will hear a clicking sound from the relay (S3).

Adjust the electromagnet height and resistor control lever until the paperclip vibrates up and down on the table. It will vibrate at a fast rate but will not move very high. Usually this works best with the electromagnet about one inch above the table and the resistor control about mid-way to the right side, but your results may vary. See how high you can make the paperclip bounce.

Adjust the electromagnet height and resistor control lever to change the height and frequency of the vibration.

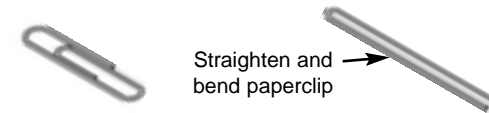

Project #676

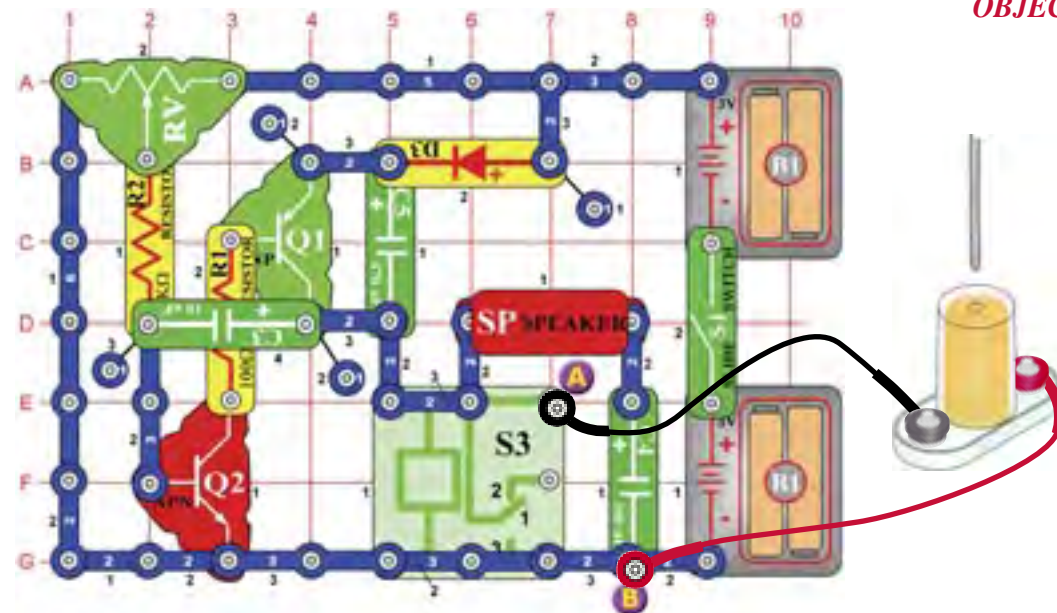

High Frequency Vibrator (II)

OBJECTIVE: *To show how electricity can lift things using magnetism.*

Take a paper clip and straighten it out, bend it in half, and place it into the electromagnet (M3) center. Connect the electromagnet to points A & B with the jumper wires and hold it about 1 inch above the table. Slide the adjustable resistor (RV) control lever around slowly, you will hear a clicking sound from the relay (S3) and speaker (SP).

Adjust the electromagnet height and resistor control lever until the paper clip vibrates up and down on the table. It will vibrate at a fast rate but will not move very high. Usually this works best with the electromagnet about one inch above the table and the resistor control about mid-way to the right side, but your results may vary. See how high you can make the paper clip bounce.

Adjust the electromagnet height and resistor control lever to change the height and frequency of the vibration.

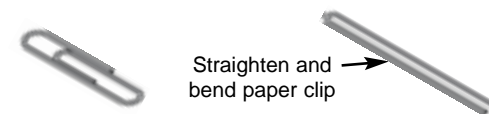

Project #677

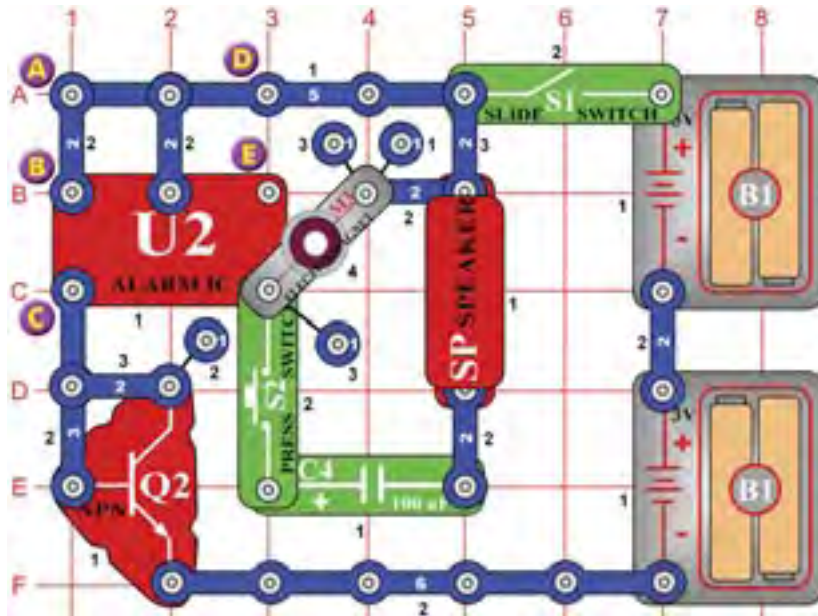

Siren Paperclip Vibrator

OBJECTIVE: To show how electricity can move things using magnetism.

Take a paperclip and straighten it out, bend it in half, and place it into the electromagnet (M3) center. Turn on the slide switch (S1), and the paperclip should vibrate.

Now press the press switch (S2), the paperclip is suspended in the air by the electromagnet and a siren alarm sounds.

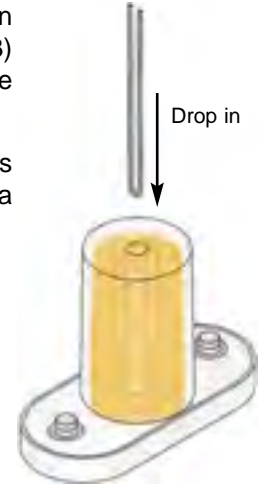
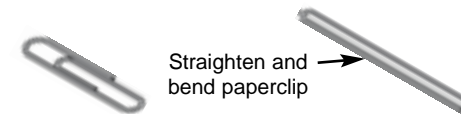

Project #678 Alarm Paperclip Vibrator

OBJECTIVE: To show how electricity can move things using magnetism.

Use the circuit from project #677, remove the connection between points A & B and make a connection between points B & C (using a spacer on point B). The sound and vibration are different now. Compare the vibration height and frequency to project #677.

Project #679 Machine Gun Paperclip Vibrator

OBJECTIVE: To show how electricity can move things using magnetism.

Now remove the connection between points B & C and make a connection between points D & E. The sound and vibration are different now. Compare the vibration height and frequency to projects #677 and #678.

Project #680

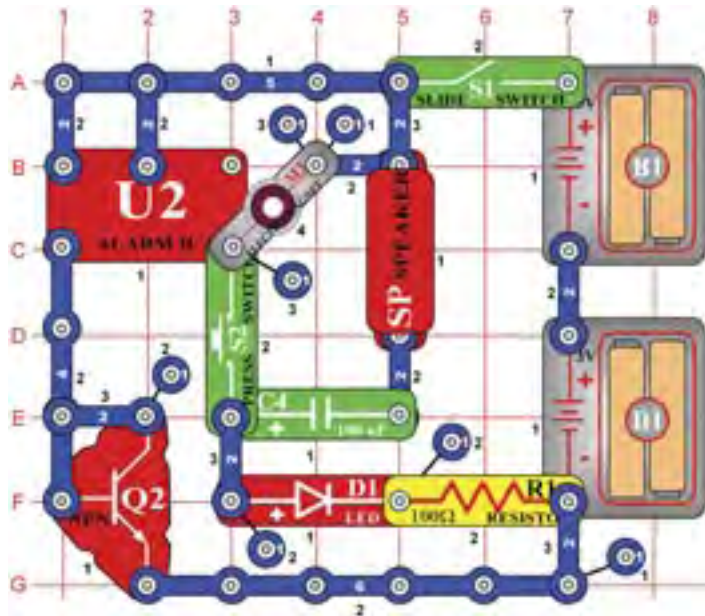

Alarm Vibrator w/ LED

OBJECTIVE: To show how electricity can move things using magnetism.

Take a paperclip and straighten it out, bend it in half, and place it into the electromagnet (M3) center. Turn on the slide switch (S1), and the paperclip should vibrate and LED (D1) flashes.

Now press the press switch (S2), the paperclip is sucked up by the electromagnet and a siren alarm sounds.

You can replace the speaker (SP) with the whistle chip (WC) to change the sound.



Straighten and bend paperclip

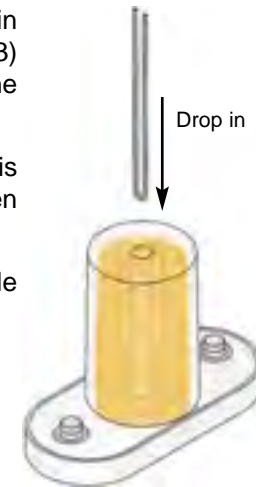
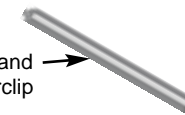

Project #681

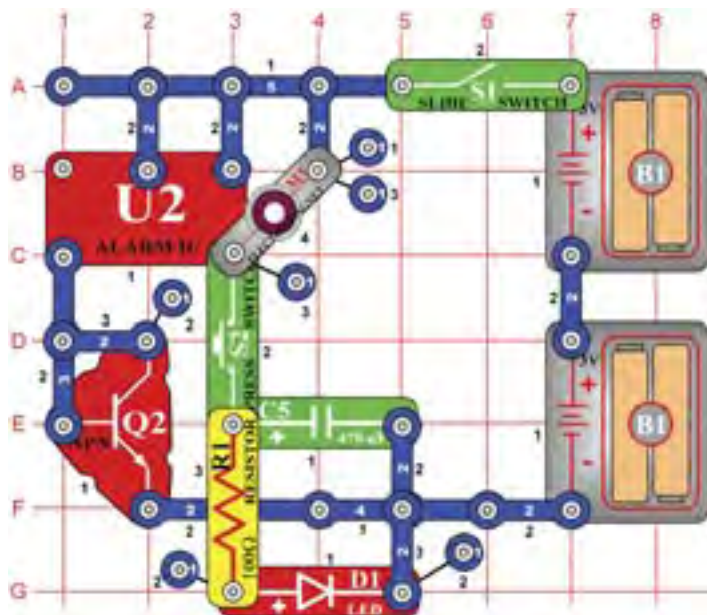

Alarm Vibrator w/ LED (II)

OBJECTIVE: To show how electricity can move things using magnetism.

Take a paperclip and straighten it out, bend it in half, and place it into the electromagnet (M3) center. Turn on the slide switch (S1), and the paperclip should vibrate.

Now press the press switch (S2), the paperclip is sucked up by the electromagnet and the LED (D1) flashes.



Straighten and bend paperclip

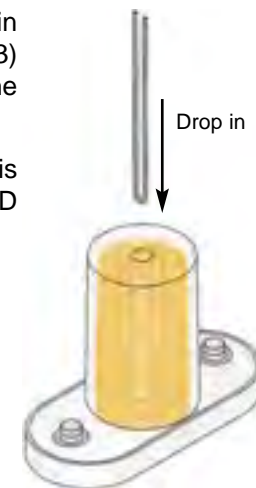
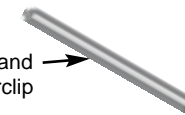

Project #682

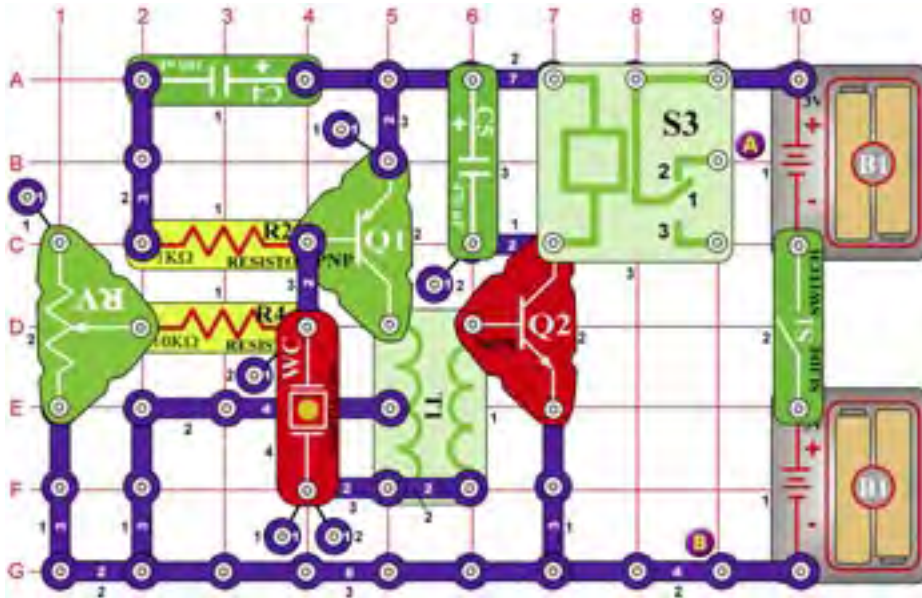

Relay-Whistle Vibrator

OBJECTIVE: To show how electricity can lift things using magnetism.

Take a paperclip and straighten it out, bend it in half, and place it into the electromagnet (M3) center. Connect the electromagnet to points A & B with the jumper wires and hold it about 1 inch above the table. Slide the adjustable resistor (RV) control lever around slowly, you will hear a clicking sound from the relay (S3) and buzzing from the whistle chip (WC).

Adjust the electromagnet height and resistor control lever until the paperclip vibrates up and down on the table. The vibration pattern may seem complex because it is due to two sources: the whistle chip and the relay.

Adjust the electromagnet height and resistor control lever to change the height and frequency of the vibration.

You can also replace the 10K Ω resistor (R4) with the photoresistor (RP). Waving your hand over it will start or stop the vibration.

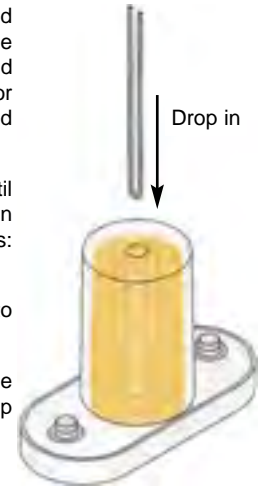
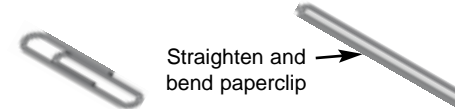

Project #683

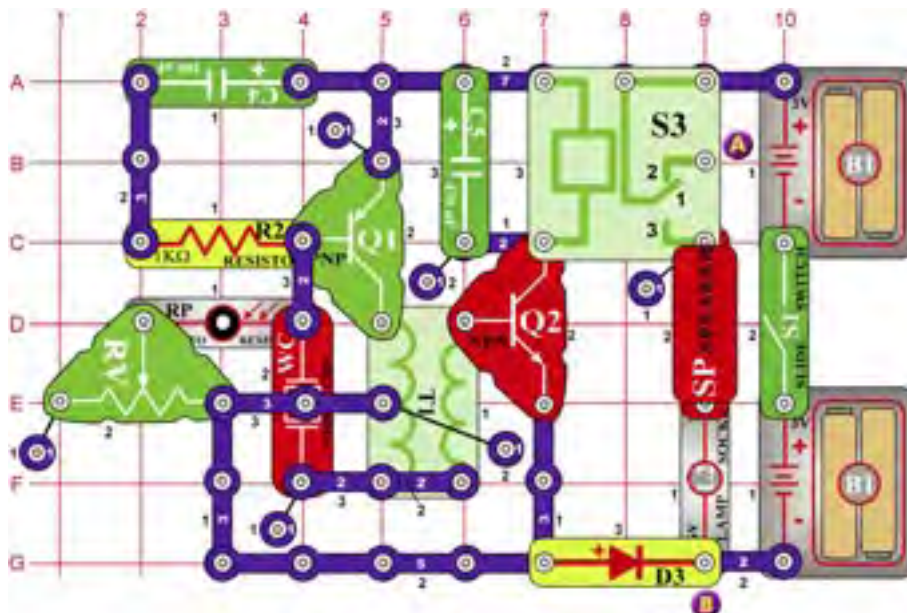

Relay-Whistle Photo Vibrator

OBJECTIVE: To show how electricity can lift things using magnetism.

Take a paperclip and straighten it out, bend it in half, and place it into the electromagnet (M3) center. Connect the electromagnet to points A & B with the jumper wires and hold it about 1 inch above the table. Slide the adjustable resistor (RV) control lever around slowly without covering the photoresistor (RP), you will hear a clicking sound from the relay (S3) and buzzing from the whistle chip (WC).

Adjust the electromagnet height and resistor control lever until the paperclip vibrates up and down on the table. Then wave your hand over the photoresistor. The vibration pattern may seem complex because it is due to three sources: the whistle chip, the relay, and the photoresistor.

Adjust the electromagnet height and resistor control lever to change the height and frequency of the vibration. Covering the photoresistor stops the vibration.

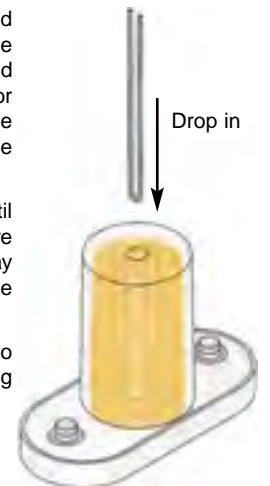
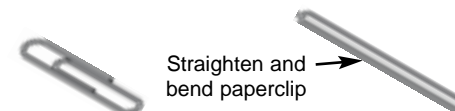

Project #684

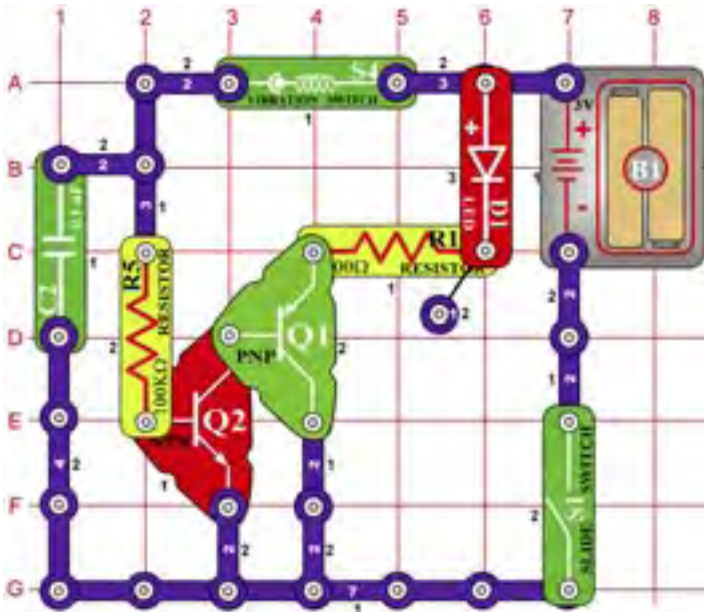

Vibration LED

OBJECTIVE: *Introduction to the vibration switch.*

The vibration switch (S4) contains two separate contacts; a spring is connected to one of the contacts. A vibration causes the spring to move briefly shorting the two contacts. This simple circuit demonstrates how the vibration switch works. Build the circuit and the LED (D1) does not light. Tap the vibration switch or table and the LED lights for every tap.

The 100K Ω resistor (R5) limits the current to protect the vibration switch while the transistors allow the vibration switch to control a large current.

Project #685

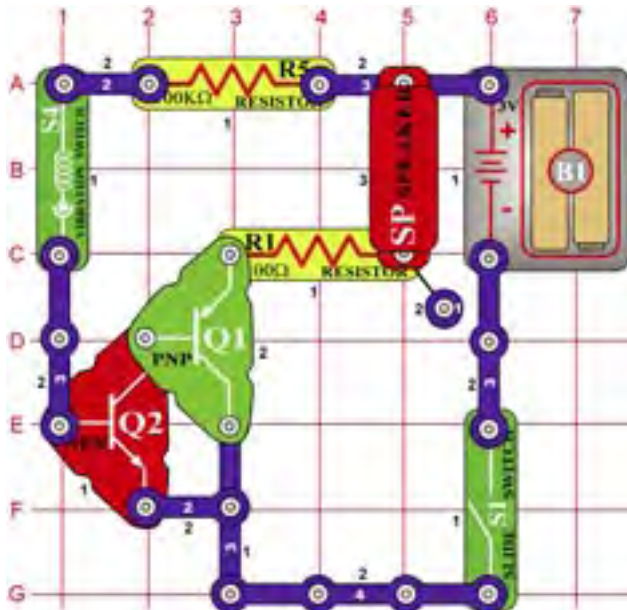

Vibration Speaker

OBJECTIVE: *To create sound with a tap of your finger.*

Build the circuit and turn on the slide switch (S1). When you tap on the vibration switch (S4), the speaker (SP) sounds. Listen closely because the sound may not be very loud.

Project #686 Measure the Vibration as You Tap the Switch

OBJECTIVE: *To use the meter with the vibration switch.*

Modify project #685 by replacing the speaker (SP) with the meter (M2). Place it with the "+" side towards R5 and use the LOW (or 10mA) setting. Tap the vibration switch (S4) and the meter deflects to the right. Tap harder on the switch; the switch closes longer and the meter deflects more to the right.

Project #687

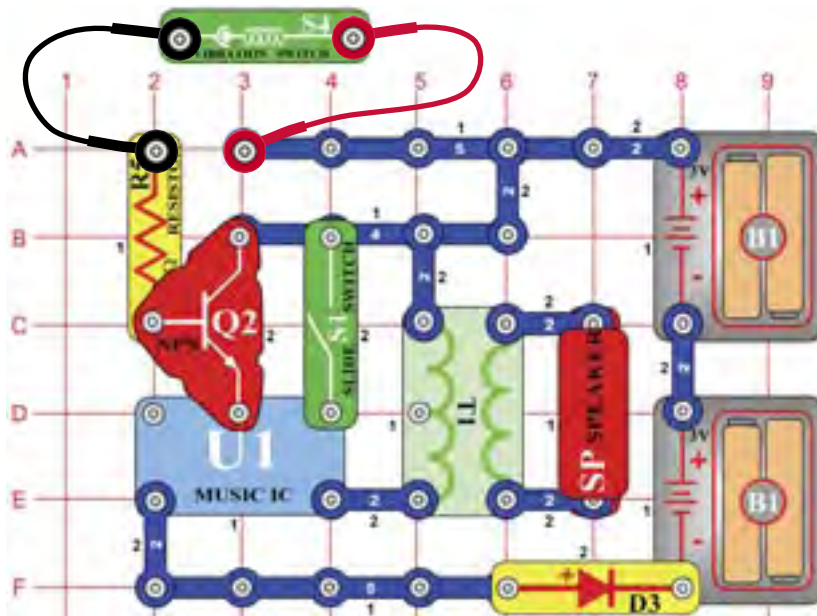

Shaky Birthday Song

OBJECTIVE: To turn the music IC on and off using the vibration switch.

Connect the vibration switch (S4) to the circuit using the red and black jumpers. Hold the vibration switch steady in your hand and the music should not play. Now move your hand, the music should briefly play. If you continuously shake the switch, the music keeps playing. Turn the slide switch (S1) on and the music plays. Change the sound by shaking the vibration switch.

Project #688

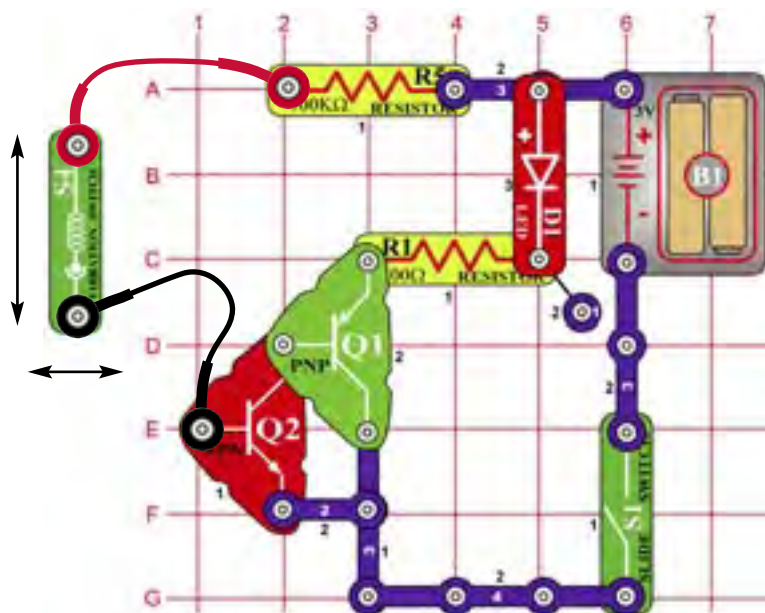

Vibration Detector

OBJECTIVE: To show the effects of horizontal and vertical direction.

Connect the vibration switch (S4) to the circuit using the black and red jumper wires. Place the switch horizontally on the table. Rapidly move the switch from left to right and notice that the LED (D1) does not light. There is not enough force to expand the internal spring to turn on the switch. Now move the switch up and down and see that the LED easily lights. It requires less force to move the spring back and forth.

You can replace the LED (D1) with the meter (M2), place it with the "+" side towards R5 and use the LOW (or 10mA) setting. The meter deflects more when you move the vibration switch up and down.

Project #689

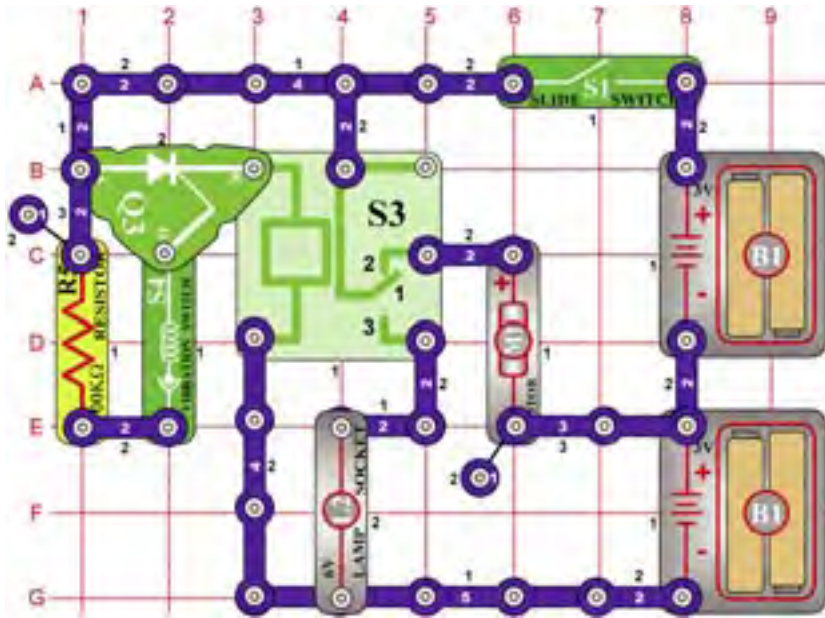

Out of Balance

OBJECTIVE: To build an out of balance turn off circuit.

The vibration switch (S4) triggers the SCR (Q3) connecting the relay's (S3) coil to the battery (B1). The relay's contacts switch, turning the motor (M1) off, and lighting the lamp (L2). The lamp will stay lit until the slide switch (S1) is turned off.

Turn the slide switch on; the motor starts to spin. If the motor generates enough vibration, the switch will trigger the SCR, turning off the motor and lighting the lamp. If the motor keeps spinning, tap on the table to trigger the vibration switch.

WARNING: Moving parts. Do not touch the fan or motor during operation.

Project #690

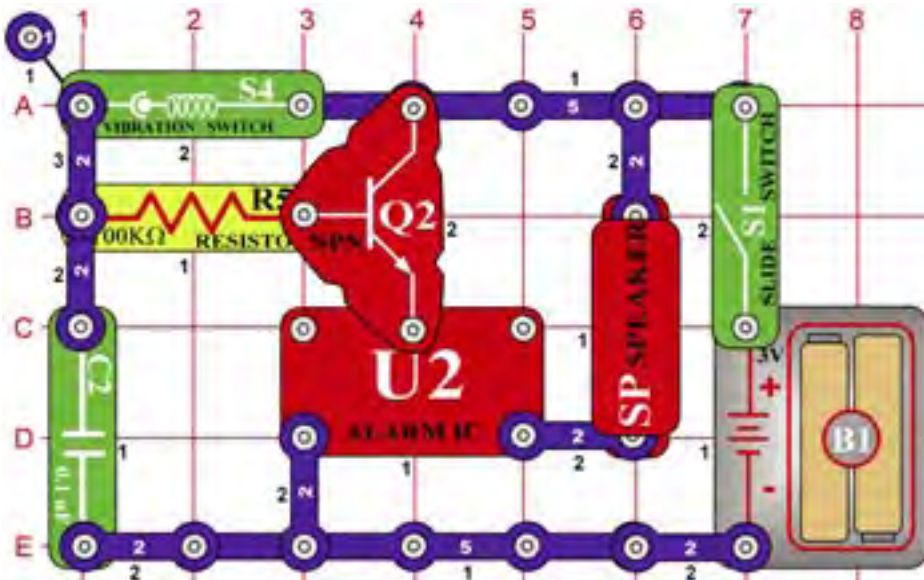

Vibration Alarm

OBJECTIVE: To sound an alarm when something is shaken.

Turn on the slide switch (S1) and shake the circuit or bang on the table; an alarm will sound. Try banging on the table in a regular pattern, and see if you can make the alarm sound continuously.

Project #691



Vibration Space War

OBJECTIVE: To make sounds when something is shaken.

Turn on the slide switch (S1) and shake the circuit or bang on the table, you will hear different sounds. Try banging on the table in a regular pattern, and see if you can make the sounds continuous.

When the vibration switch (S4) is shaken, the circuit plays out one of eight sounds.

Project #692

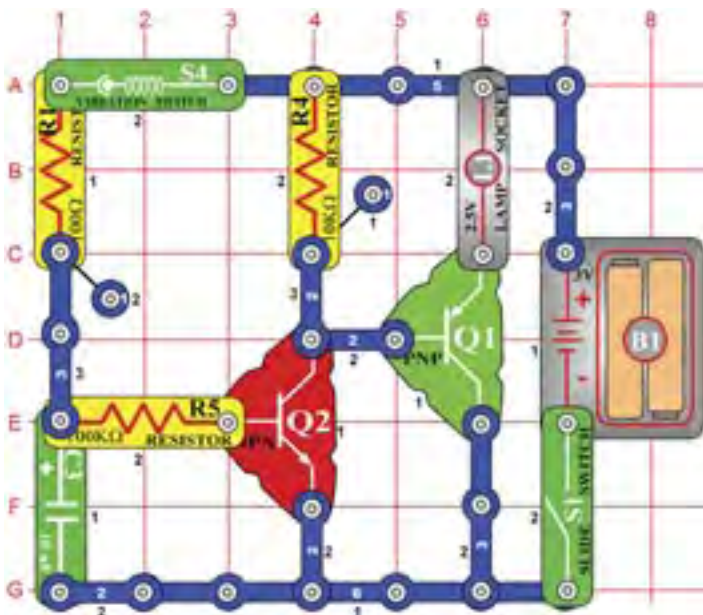

Vibration Light

OBJECTIVE: To build a lamp that stays on for a while.

Turn on the slide switch (S1) and shake the base grid or bang on the table. The lamp (L1) turns on when there is vibration, and stays on for a few seconds.

OTHER FUN ELENCO® PRODUCTS!

Elenco® has over 200 electronics and science kits, along with hundreds of other electronics products. To see the complete line of products and where to buy them, visit our website www.elenco.com or call us toll-free at (800) 533-2441. For Snap Circuits® upgrade kits and accessories, go to www.snapcircuits.net.

Snaptricity Model SCBE-75 Build Over 75 Projects

Learn how electricity and magnetism can be used to make each other, learn about magnetic fields, how the electricity in your home works, how switches control the electricity to the lights in your home, and how series and parallel circuits affect electricity.

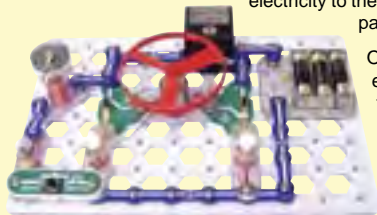

Over 40 parts including: Meter, electromagnet, motor, lamps, switches, fan, compass, and electrodes.

Educational Toy: Projects that relate to electricity in the home and magnetism and how it is used. Build over 75 projects.

Deluxe Telephone Kit Model FUN-755



- Fully Modular
- Last Number Redial
- Desk/Wall Mount
- Tone/Pulse Switchable
- Ringer with ON/OFF Switch
- Neon Lights Flash when Phone Rings
- Hearing Aid Compatible
- Full-color Assembly Manual
- Lighted Dial Keypad
- Transparent Blue Case
- FCC Approved

Custom Storage Case Model SNAPCASE7



Heavy duty plastic case with 2 custom foam inserts for housing your Snap Circuits® parts. Easy to identify missing components. Also includes a separate small case to hold the smaller loose parts.

(for use with SC-750)

Radio-Controlled Race Car Model FUN-875

The purpose of this project is to expand your understanding of basic transmitters, receivers and electronic switching theories. Your Turbo King Car will be built from the ground up. You'll learn all about gears, motors, printed circuit boards, and integrated circuits from our detailed assembly and training manual. You will construct each section, explore the circuitry and troubleshoot it.



Requires 1 9V and 4 "AA" batteries.

Talking Clock Kit Model FUN-225

This easy-to-build kit will teach you how electronic voices are made. No soldering is required and our full color assembly manual takes you step-by-step in putting it together. Features hourly reports and rooster crow for alarm.



Requires 2 "AA" batteries.

AC Power Supply Part # AC-SNAP

Replaces the batteries in Snap Circuits®.



Solar Deluxe Educational Kit Model SK-40

By solar power, harness the power of the sun with this environment-friendly D.I.Y. kit!

You can do a series of do-it-yourself experiments to acquire the basic knowledge of solar energy.

You can learn how to make an electrical circuit, make a solar circuit, how to increase voltage and current, and how to use solar power to produce energy for a radio, calculator, battery charger, a cassette player and more!



Cola Clock Kit Model FUN-285

Cola not only quenches your thirst, but can power a clock too! Build this kit and amaze your family and friends with this cola-powered clock.

Learn how batteries work when you use cola to make a chemical reaction that powers a clock. Completely safe and doesn't require batteries! Parts are easily identified and assembled with full color manual.

No batteries required!



Student Guide

Part #'s 753289, 753291, 753301

For use with SC-750.

Educational Series - teaches Basic Electricity & Electronics in the everyday world using our Learn By Doing® concept! 32 full-color pages, and written with the help of educators.

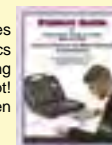

Elenco® provides a circuit designer so that you can make your own Snap Circuits® drawings. This Microsoft® Word document can be downloaded from www.snapcircuits.net/SnapDesigner.doc or through the www.snapcircuits.net web site.

OTHER FUN ELENCO® PRODUCTS!

Project Labs

No Soldering Required

500-in-1 Electronic Project Lab Model MX-909

Everything you need to build 500 exciting electronic projects. Learn the basics of electronics and put your knowledge to work creating projects that explore amplifiers, analog and digital circuits plus learn how to read schematic diagrams. Includes built-in breadboard for easy wiring and connection of components and an LCD (liquid crystal display) which indicates the information for the experiment in progress. Includes breadboard and spring hook-up methods.



Chem-Science Model EDU-7070

35+ fun activities with home science and kitchen chemistry. Investigate with safe and simple materials - discover basic scientific laws and phenomena.

Grow crystals; create a volcano; separate pigments; make your own gook, glue, perfume and plastic; split up water; learn about pH, colloids and emulsions; write magic messages; see gases expand and more!



My Senses Model EDU-7086

This kit is part of our Body Awareness Science Series, exploring the five senses: sight, hearing, smell, taste, and touch. Perform over 50 fascinating experiments. Use a genuine stethoscope, make a telescope with real lenses and create rainbows with a prism. Prepare perfume and stink bombs with chemistry lab equipment. Learn how to read and send messages in Braille. Also includes many activities suitable for party games.



Weather Model EDU-7074

Over 30 fascinating activities all about weather and climate. Build your own barometer, weather vane, rain gauge, and hydrometer. Observe the weather traits and see how they'll affect tomorrow's weather. Make a rainbow, produce clouds, lightning, rain, and even a thunderstorm!



Detectolab Model EDU-7080

Investigate, analyze, decipher and solve the crime! Over 65 activities with fingerprints, secret messages, chromatography, cipher codes, identity detection and more... Kit includes 30X microscope and necessary lab equipment.



iBOTZ Non-soldering

iBOTZ Soundtracker Kit

Model MR-1001 (Sound Sensor)

The Soundtracker will react to sound impulses and objects in its way. It will reverse away from a sound or obstruction, then move forward. Kit contains detailed instructions and educational background information on each component used and why. The kit will teach the fundamentals of sensor technology and show you how it all goes together.

No soldering required.



Movement: Three (3) wheels driven by a DC motor.
Control: Sound sensor including condenser microphone.
Dimensions: 3 3/4" (H) x 5 1/2" (W) x 4 15/16" (L)

Requires two (2) "AA" batteries (part # 590001).

iBOTZ Antoid Kit

Model MR-1002 (Infrared Sensor)

The Antoid will react to obstacles in its way by means of its electronic "eye". To build this educational robot requires only basic hand tools. Kit contains detailed instructions and educational background information on each component used and why. The kit will teach the fundamentals of sensor technology and show you how it all goes together.

No soldering required.

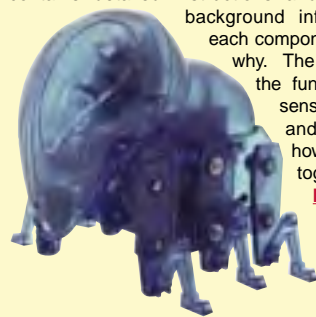

Movement: Six (6) legs driven by two (2) DC motors.
Control: Infrared sensor.
Dimensions: 6 1/8" (H) x 7 1/16" (W) x 5 29/32" (L)

Requires one (1) 9V (part # 590009) and two (2) "AA" batteries (part # 590001).

iBOTZ Hydrazoid Kit

Model MR-1004 (Sound Sensor)

Hydrazoid is a cool alien creature that is fun to build. Hydrazoid moves in a spellbinding way in response to sound. To build this educational robot requires only basic hand tools. Kit contains detailed instructions and educational background information on each component used and why.

The kit will teach the fundamentals of sensor technology and show you how it all goes together.

No soldering required.



Movement: Four (4) legs driven by a DC motor.
Control: Sound sensor including condenser microphone.
Dimensions: 2 3/4" (H) x 1 3/4" (W) x 2 5/32" (L)

Requires two (2) "AA" batteries (part # 590001).

iBOTZ TriBotz Kit

(Infrared, Sound & Touch Sensors) Model MR-1005

TriBotz is three robots in one package. It uses sensors to avoid objects, follow a line and respond to sound. The TriBotz will react to sound impulses and objects in its way. It will reverse away from a sound or obstruction, then move forward. Make a path with a black felt tip marker or black tape and watch how infrared sensors allow the TriBotz to make

corrections.
No soldering required.



Movement: Two (2) wheels driven by two (2) DC motors.
Control: Sound sensor including condenser microphone, infrared light sources and light detectors.
Dimensions: 3 15/16" (H) x 5 7/8" (W) x 5 1/2" (L)

Requires two (2) "AA" batteries (part # 590001).



99 Washington Street
Melrose, MA 02176
Phone 781-665-1400
Toll Free 1-800-517-8431

 Visit us at www.TestEquipmentDepot.com