

SNAP CIRCUITS®

SOUND



Projects 1-188



Project 47

AGES
8 & up

ELENCO®

Table of Contents

Basic Troubleshooting	1	DO's and DON'Ts of Building Circuits	15
Parts List	2, 3	Advanced Troubleshooting	16, 17
How to Use Snap Circuits®	4	Project Listings	18, 19
About Your Snap Circuits® SOUND Parts	5-7	Projects 1 - 188	20-85
Introduction to Electricity	8	Other Snap Circuits® Projects	86
Sound in Our World	9-14		



WARNING: SHOCK HAZARD - Never connect Snap Circuits® to the electrical outlets in your home in any way!



WARNING: CHOKING HAZARD - Small parts. Not for children under 3 years.

Conforms to all applicable U.S. government requirements.

Basic Troubleshooting

1. Most circuit problems are due to incorrect assembly, always double-check that your circuit exactly matches the drawing for it.
2. Be sure that parts with positive/negative markings are positioned as per the drawing.
3. Be sure that all connections are securely snapped.
4. Try replacing the batteries.
5. If the flexible sheet in the sound energy demo container is damaged, replace it with a spare (if one was included), or use household plastic wrap.
6. If the echo IC (U28) stops working, turn the circuit off and on to reset it.

ELENCO® is not responsible for parts damaged due to incorrect wiring.

Note: If you suspect you have damaged parts, you can follow the Advanced Troubleshooting procedure on pages 16 and 17 to determine which ones need replacing.

WARNING: Always check your wiring before turning on a circuit. Never leave a circuit unattended while the batteries are installed. Never connect additional batteries or any other power sources to your circuits. Discard any cracked or broken parts.

Adult Supervision: Because children's abilities vary so much, even with age groups, adults should exercise discretion as to which experiments are suitable and safe (the instructions should enable supervising adults to establish the experiment's suitability for

the child). Make sure your child reads and follows all of the relevant instructions and safety procedures, and keeps them at hand for reference.

This product is intended for use by adults and children who have attained sufficient maturity to read and follow directions and warnings.

Never modify your parts, as doing so may disable important safety features in them, and could put your child at risk of injury.











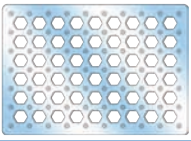





Batteries:

- Use only 1.5V "AA" type, alkaline batteries (not included).
- Insert batteries with correct polarity.
- Non-rechargeable batteries should not be recharged. Rechargeable batteries should only be charged under adult supervision, and should not be recharged while in the product.
- Do not mix old and new batteries.
- Do not connect batteries or battery holders in parallel.
- Do not mix alkaline, standard (carbon-zinc), or rechargeable (nickel-cadmium) batteries.
- Remove batteries when they are used up.
- Do not short circuit the battery terminals.
- Never throw batteries in a fire or attempt to open its outer casing.
- Batteries are harmful if swallowed, so keep away from small children.



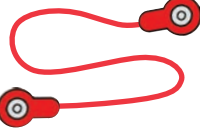













Parts List (Colors and styles may vary) Symbols and Numbers (page 1)

Important: If any parts are missing or damaged, **DO NOT RETURN TO RETAILER.** Call toll-free (800) 533-2441 or e-mail us at: help@elenco.com. Customer Service • 150 Carpenter Ave. • Wheeling, IL 60090 U.S.A.

Qty.	ID	Name	Symbol	Part #	Qty.	ID	Name	Symbol	Part #
1		Base Grid (11.0" x 7.7")		6SCBG	1	C2	0.1mF Capacitor		6SCC2
3	1	1-Snap Wire		6SC01	1	C5	470mF Capacitor		6SCC5
7	2	2-Snap Wire		6SC02	1	C7	1mF Capacitor		6SCC7
3	3	3-Snap Wire		6SC03	1	D8	Color Light Emitting Diode (LED)		6SCD8
1	4	4-Snap Wire		6SC04	1		Egg LED Attachment		6SCEGG
1	5	5-Snap Wire		6SC05	1		Jumper Wire (black)		6SCJ1
1	6	6-Snap Wire		6SC06	1		Jumper Wire (red)		6SCJ2
2	B1	Battery Holder - uses two (2) 1.5V type "AA" (not included)		6SCB1	1	JA	Audio Jack		6SCJA

Parts List (Colors and styles may vary) Symbols and Numbers (page 2)

Important: If any parts are missing or damaged, **DO NOT RETURN TO RETAILER.** Call toll-free (800) 533-2441 or e-mail us at: help@elenco.com. Customer Service • 150 Carpenter Ave. • Wheeling, IL 60090 U.S.A.

Qty.	ID	Name	Symbol	Part #	Qty.	ID	Name	Symbol	Part #
☐ 1	Q2	NPN Transistor		6SCQ2	☐ 1		Tube for Sound Energy Demo Container		6SCSEDCT
☐ 1	R1	100W Resistor		6SCR1	☐ 1		Flexible Sheet for Sound Energy Demo Container (may include spare)		6SCSEDCF
☐ 1	R3	5.1kW Resistor		6SCR3	☐ 1	SP2	Speaker		6SCSP2
☐ 1	RV	Adjustable Resistor		6SCRV	☐ 1	U26	Keyboard		6SCU26
☐ 1	RV3	500kW Adjustable Resistor		6SCRV3	☐ 1	U27	Voice Changer		6SCU27
☐ 1	RP	Photoresistor		6SCRP	☐ 1	U28	Echo IC		6SCU28
☐ 2	S1	Slide Switch		6SCS1	☐ 1	X1	Microphone		6SCX1
☐ 1	S2	Press Switch		6SCS2	☐ 1		Stereo Cable		9TLSCST
☐ 1		Base for Sound Energy Demo Container		6SCSEDCB					

How to Use Snap Circuits®

Snap Circuits® uses building blocks with snaps to build the different electrical and electronic circuits in the projects. Each block has a function: there are switch blocks, light blocks, battery blocks, different length wire blocks, etc. These blocks are different colors and have numbers on them so that you can easily identify them. The blocks you will be using are shown as color symbols with level numbers next to them, allowing you to easily snap them together to form a circuit.

For Example:

This is the switch block, which is green and has the marking **S2** on it. The part symbols in this booklet may not exactly match the appearance of the actual parts, but will clearly identify them.



This is a wire block, which is blue and comes in different wire lengths. This one has the number **2**, **3**, **4**, **5** or **6** on it depending on the length of the wire connection required.



There is also a 1-snap wire that is used as a spacer or for interconnection between different layers.



You need a power source to build each circuit. This is labeled **B1** and requires two (2) 1.5V "AA" batteries (not included).



A large clear plastic base grid is included with this kit to help keep the circuit blocks properly spaced. You will see evenly spaced posts that the different blocks snap into. The base has rows labeled A-G and columns labeled 1-10.

Next to each part in every circuit drawing is a small number in black. This tells you which level the component is placed at. Place all parts on level 1 first, then all of the parts on level 2, then all of the parts on level 3, etc.

Some circuits use the jumper wires to make unusual connections. Just clip them to the metal snaps or as indicated.



This set contains an egg LED attachment, which can be mounted on the color LED (D8) to enhance its light effects.



Egg



Egg LED attachment mounted to D8

Sound Energy Demonstration Container Assembly

(Adult supervision recommended)

This set contains a sound energy demonstration container, which will sometimes be placed over the speaker. Its use is explained in project 13.

To assemble it, lay the tube and flexible sheet over the base, and then push the tube into the base, as shown. Do not disassemble it except to repair it. This set may include a spare for the flexible sheet, and household plastic wrap also works.

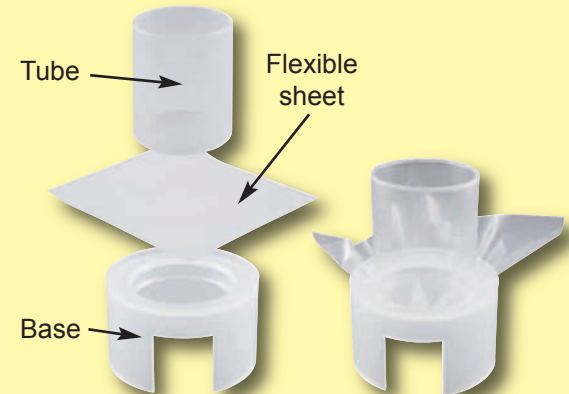

Note: While building the projects, be careful not to accidentally make a direct connection across the battery holder (a "short circuit"), as this may damage and/or quickly drain the batteries.

About Your Snap Circuits® SOUND Parts

(Part designs are subject to change without notice).

BASE GRID

The **base grid** is a platform for mounting parts and wires. It functions like the printed circuit boards used in most electronic products, or like how the walls are used for mounting the electrical wiring in your home.

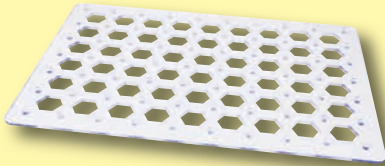

SNAP WIRES & JUMPER WIRES

The blue **snap wires** are wires used to connect components. They are used to transport electricity and do not affect circuit performance. They come in different lengths to allow orderly arrangement of connections on the base grid.

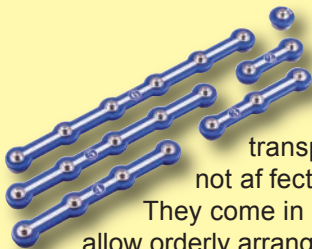

The red and black **jumper wires** make flexible connections for times when using the snap wires would be difficult. They also are used to make connections off the base grid.



Wires transport electricity just like pipes are used to transport water. The colorful plastic coating protects them and prevents electricity from getting in or out.

BATTERY HOLDER

The **batteries (B1)** produce an electrical **voltage** using a chemical reaction. This “voltage” can be thought of as electrical pressure, pushing electricity through a circuit just like a pump pushes water through pipes. This voltage is much lower and much safer than that used in your house wiring. Using more batteries increases the “pressure”, therefore, more electricity flows.

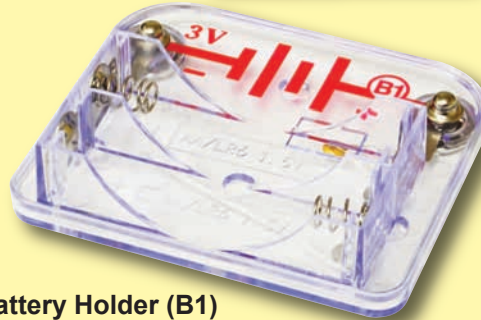
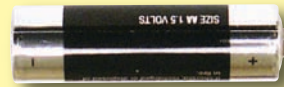

Battery Holder (B1)

SLIDE & PRESS SWITCHES

The **slide & press switches (S1 & S2)** connect (pressed or “ON”) or disconnect (not pressed or “OFF”) the wires in a circuit. When ON they have no effect on circuit performance. Switches turn on electricity just like a faucet turns on water from a pipe.

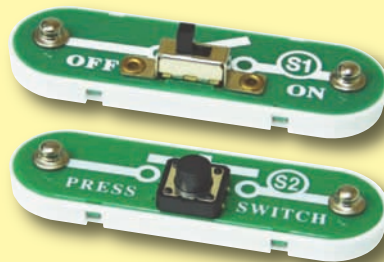

Slide & Press Switches (S1 & S2)

RESISTORS

Resistors “resist” the flow of electricity and are used to control or limit the current in a circuit. Snap Circuits® SOUND includes **100W (R1)** and **5.1kW (R3)** resistors (“k” symbolizes 1,000, so R3 is really 5,100 W). Materials like metal have very low resistance (<1 W), while materials like paper, plastic, and air have near-infinite resistance. Increasing circuit resistance reduces the flow of electricity.



Resistors (R1 & R3)

The **adjustable resistor (RV)** is a 50kW resistor but with a center tap that can be adjusted between 200W and 50kW.



Adjustable Resistor (RV)

The **500kW adjustable resistor (RV3)** is a 500kW resistor that can be adjusted between 200W and 500kW.



500kW Adjustable Resistor (RV3)

About Your Snap Circuits® SOUND Parts

The **photoresistor (RP)** is a light-sensitive resistor, its value changes from nearly infinite in total darkness to about 1000Ω when a bright light shines on it.



Photoresistor (RP)

SPEAKER

The **speaker (SP)** converts electricity into sound by making mechanical vibrations. These vibrations create variations in air pressure, which travel across the room. You "hear" sound when your ears feel these air pressure variations.



Speaker (SP2)

MICROPHONE

The **microphone (X1)** is actually a resistor that changes in value when changes in air pressure (sounds) apply pressure to its surface.

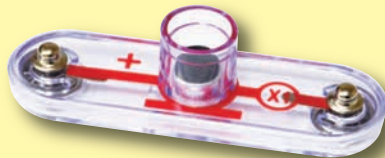

Microphone (X1)

LED

The **color LED (D8)** is a light emitting diode, and may be thought of as a special one-way light bulb. In the "forward" direction, (indicated by the "arrow" in the symbol) electricity flows if the voltage exceeds a turn-on threshold (about 1.5V for red, about 2.0V for green, and about 3.0V for blue); brightness then increases. The color LED contains red, green, and blue LEDs, with a micro-circuit controlling them. A high current will burn out an LED, so the current must be limited by other components in the circuit. LEDs block electricity in the "reverse" direction.

Color LED (D8)



CAPACITOR

The **0.1mF, 1mF, and 470mF capacitors (C2, C7, & C5)** can store electrical pressure (voltage) for periods of time. This storage ability allows them to block stable voltage signals and pass changing ones. Capacitors are used for filtering and delay circuits.

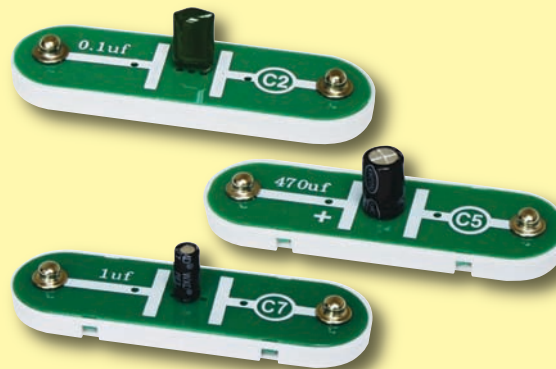

Capacitors (C2, C5, & C7)

TRANSISTORS

The **NPN transistor (Q2)** is a component that uses a small electric current to control a large current, and is used in switching, amplifier, and buffering applications. Transistors are easy to miniaturize, and are the main building blocks of integrated circuits including the microprocessor and memory circuits in computers.



NPN Transistor (Q2)

ELECTRONIC MODULES

The **keyboard (U26)** contains resistors, capacitors, switches, and an integrated circuit. It can produce two adjustable audio tones at the same time. The tones approximate musical notes, and may not be exact. The tone of the green keys can be adjusted with the tune knob or using external resistors and capacitors. A schematic for it is available at www.snapcircuits.net/faq.



Connections:

- (+) - power from batteries
- RES - resistor freq adjust
- CAP - capacitor freq adjust
- OUT - output connection
- (-) - power return to batteries

Keyboard (U26)

See projects 1, 6, & 25 for example of proper connections.

About Your Snap Circuits® SOUND Parts

The **echo IC (U28)** contains resistors, capacitors, and integrated circuits that are needed to add echo effects to a sound. A schematic for it is available at www.snapcircuits.net/faq.



Connections:

(+) - power from batteries
G+ - gain control
G- - gain control
ADJ - echo adjust
INP - input connection
OUT - output connection
(-) - power return to batteries

See projects 10 & 41 for examples of proper connections.

The **voice changer (U27)** contains resistors, capacitors, and an integrated circuit that are needed to record and play back sound at different speeds. A schematic for it is available at www.snapcircuits.net/faq.



Connections:

(+) - power from batteries
SPD - speed adjust
SP+ - speaker (+)
SP- - speaker (-)
MIC+ - microphone (+)
MIC- - microphone (-)
REC - record
PLY - play
(-) - power return to batteries

See project 7 for example of proper connections.

OTHER PARTS

The egg LED attachment can be used with the color LED (D8) to enhance the light effects.



Egg

The stereo cable is used to connect the audio jack (JA) to your music device or external speaker.



The sound energy demonstration container is used to show that sound waves have energy, and can move things around. See project 13.

The **audio jack (JA)** is a connector mounted on snaps, and is used for interfacing your music device or external speaker to Snap Circuits®.



Audio Jack (JA)



Introduction to Electricity

What is electricity? Nobody really knows. We only know how to produce it, understand its properties, and how to control it. Electricity is the movement of sub-atomic charged particles (called **electrons**) through a material due to electrical pressure across the material, such as from a battery.

Power sources, such as batteries, push electricity through a circuit, like a pump pushes water through pipes. Wires carry electricity like pipes carry water. Devices like LEDs, motors, and speakers use the energy in electricity to do things. Switches and transistors control the flow of electricity like valves and faucets control water. Resistors limit the flow of electricity.

The electrical pressure exerted by a battery or other power source is called **voltage** and is measured in **volts** (V). Notice the “+” and “-” signs on the battery; these indicate which direction the battery will “pump” the electricity.

The **electric current** is a measure of how fast electricity is flowing in a wire, just as the water current describes how fast water is flowing in a pipe. It is expressed in **amperes** (A) or **milliamps** (mA, 1/1,000 of an ampere).

The “**power**” of electricity is a measure of how fast energy is moving through a wire. It is a combination of the voltage and current (Power = Voltage x Current). It is expressed in **watts** (W).

The **resistance** of a component or circuit represents how much it resists the electrical pressure (voltage) and limits the flow of electric current. The relationship is Voltage = Current x Resistance. When the resistance increases, less current flows. Resistance is measured in **ohms** (W), or **kilo ohms** (kW, 1,000 ohms).

Nearly all of the electricity used in our world is produced at enormous generators driven by steam or water pressure. Wires are used to efficiently transport this energy to homes and businesses where it is used. Motors convert the electricity back into mechanical form to drive machinery and appliances. The most important aspect of electricity in our society is that it allows energy to be easily transported over distances.

Note that “distances” includes not just large distances but also tiny distances. Try to imagine a plumbing structure of the same complexity as the circuitry inside a portable radio - it would have to be large because we can't make water pipes so small. Electricity allows complex designs to be made very small.

There are two ways of arranging parts in a circuit, in series or in parallel. Here are examples:

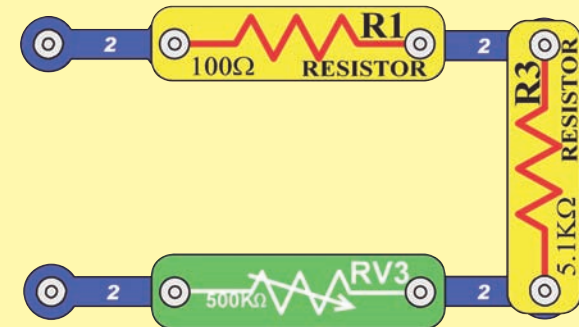

Series Circuit

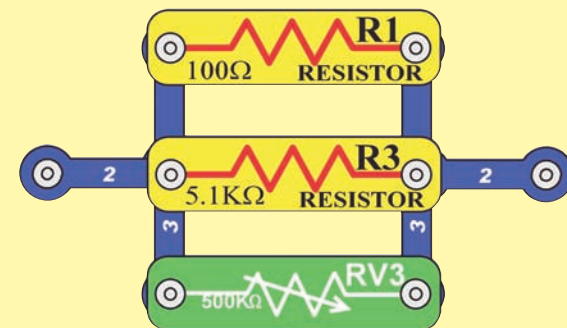

Parallel Circuit

Placing components in series increases the resistance; highest value dominates. Placing components in parallel decreases the resistance; lower value dominates.

The parts within these series and parallel sub-circuits may be arranged in different ways without changing what the circuit does. Large circuits are made of combinations of smaller series and parallel circuits.

Sound in Our World

Sound is a variation in air pressure created by a mechanical vibration. See projects 13 & 51 for a demonstration of this. These air pressure variations travel across the room like waves, so we call them **sound waves**. You “hear” sound when your ears feel these air pressure variations, and convert them to nerve pulses that your brain interprets. Eventually the energy of a sound wave is absorbed, and becomes heat.

Sound waves can also be thought of as waves of temporary compression that travel through materials. Notice that at a loud concert you can sometimes feel the pressure waves, in addition to hearing them. Sound waves can travel through liquids and solids but their speed may change and their energy may be reduced, depending on the characteristics of the material. Sound waves can only travel through a compressible material, and so cannot travel through a vacuum. Outer space is silent, because there is no air or other material for sound waves to travel through.

The “hearing” part of your ear is inside your skull; the flaps you see are just funnels to collect the sound and pass it along to your eardrum inside. When you were young your brain learned to interpret the difference in the information collected from your two ears, and use it to know which direction a sound came from. If one of your ears is clogged, then it is difficult to determine a sound’s direction.

You can compare sound waves from your voice to waves in a pond. When you speak, the movements in your mouth create sound waves just as tossing a rock into the pond creates water waves. Sound waves travel through air as water waves travel across the pond. If someone is nearby, then their ears will feel the air pressure variations caused by your

sound waves just as a small boat at the other side of the pond will feel the water waves.



If the mechanical vibration causing the sound wave occurs at a constant rate, then the sound wave will repeat itself at the same rate; we refer to this as the frequency of the sound wave. Nearly all sound waves have their energy spread unevenly across a range of frequencies. When you say a word, you create a sound wave with energy at various frequencies, just as tossing a handful of various-sized rocks into the pond will create a complicated water wave pattern.

Frequency measures how many times something occurs per second, expressed in units called hertz (Hz). The metric prefixes can be used, so 1,000 repetitions per second is 1 kilohertz (kHz) and 1,000,000 repetitions per second is 1 megahertz (MHz). The range of frequencies that can be heard by the human ear is approximately 20 to 20,000 Hz and is referred to as the audio range.

Just as there are sound waves caused by mechanical vibrations, there are also electrical waves caused by electrical variations. Just as sound waves travel through air, electrical waves travel through wires. A microphone senses pressure variations from sound waves and creates electrical waves at the same frequencies. A speaker converts electricity into

sound, by using the energy in electrical waves to create mechanical vibrations (sound waves) at the same frequencies.

How does the speaker make sound? An electric current flowing through a wire has a very, very tiny magnetic field. Inside the speaker is a coil of wire and a magnet. The coil of wire concentrates the magnetic field from the flowing electric current, enough to make the magnet move slightly, like a vibration. The magnet’s vibration creates the air pressure variations that travel to your ears.

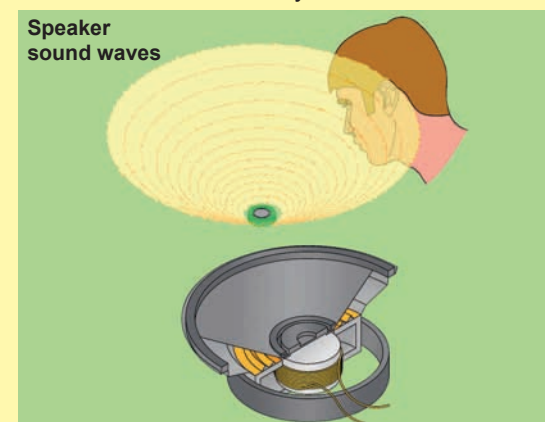

Your speaker can only create sound from a **CHANGING** electrical signal, for unchanging electrical signals it acts like a 32 ohm resistor. (An unchanging signal does not cause the magnet in the speaker to move, so no sound waves are created). Electrical variations at high frequencies (referred to as radio frequencies) cannot be heard by your ears, but can be used to create **electromagnetic radio waves**, which travel through air and are used for many forms of communication. In AM and FM radio, voice or music is superimposed on radio waves, allowing it to be transmitted over great distances, to later be decoded and listened to.

Sound in Our World

In stereo, sound is produced on several speakers (or earphones) with varying frequencies/loudness on each. This gives the impression that the sound is coming from different directions, and is more pleasing to listen to. **Mono** sound is the same on all speakers, and is easier to produce. Note that a “stereo speaker” can be several speakers (possibly of different sizes) in one package. Your Snap Circuits® speaker (SP2) is a mono speaker. **Surround sound** is a technique for placing several speakers (with different sounds from each) around the listener, to create a more interesting listening experience.

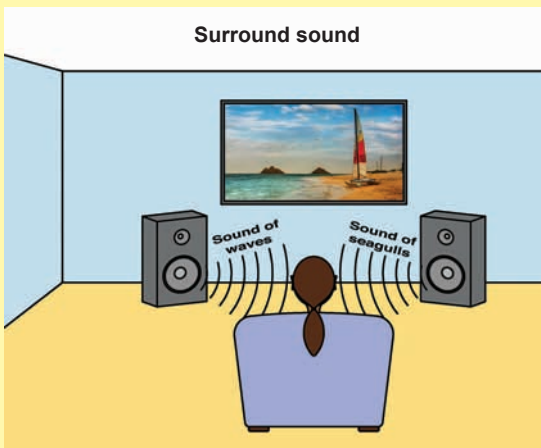

The loudness of sound waves is a measure of the pressure level, and is expressed in decibels (dB, a logarithmic scale). Long-term exposure to loud sounds can lead to hearing loss. Here are some examples of sound levels:

Sound Source	Level
Threshold of pain	130dB
Chain saw	110dB
Normal conversation	50dB
Calm breathing	10dB
Hearing threshold	0dB

Sound waves travel very fast, but sometimes you can perceive the effects of their speed. Ever notice how sometimes you see lightning before you hear the thunder? The reason is because light travels at about 186,000 miles per second, while sound travels at only about 1,100 feet per second in air. Sound can travel through liquids and solids, but with increased speed (the speed depends on the material's compressibility and density). Sound travels 4.3 times faster in water than in air; this difference in speed confuses our ears, making it difficult to perceive the direction of sound while underwater.

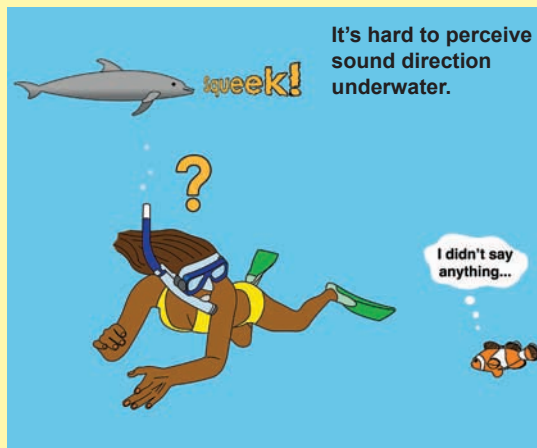

A sonic boom is a shock wave that occurs when an object travels through air at supersonic speeds (faster than the speed of sound). These sonic shock waves are similar to how the bow of a boat produces waves in the water. Sonic shock waves can carry a lot of sound energy and can be very unpleasant to hear, like an explosion. Aircraft can fly at supersonic speeds, and the sonic boom produced is so unpleasant that aircraft are rarely permitted to fly at supersonic speeds over populated areas.

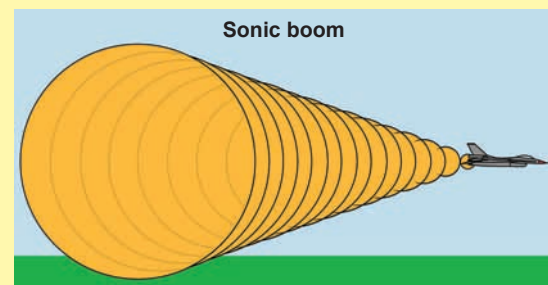

Sound waves can reflect off walls and go around corners, though their energy may be reduced depending on the angle and the roughness of the surface. Sometimes sound waves can be channeled to focus in a certain direction. As an example, get a long tube, like the ones for wrapping paper. Use one of the projects that make a continuous tone, such as projects 6 or 92. Hold one end of the tube next to the speaker (use the yellow side with the grating) and the other end near your ear, then remove the tube and compare the sound volume at the same distance from the speaker. The long tube should make the sound reaching your ear louder, because sound waves reflect off the tube walls and stay concentrated, instead of spreading out across the room.

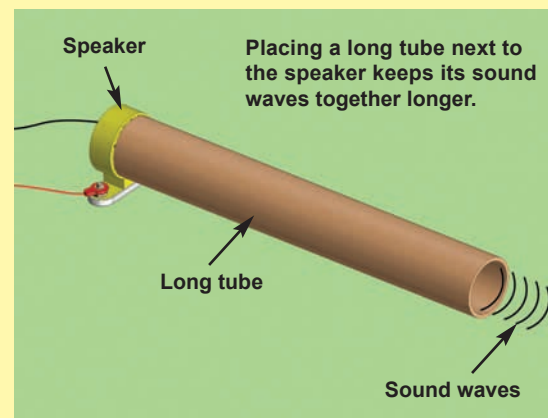

Sound in Our World

Some of a sound wave's energy can reflect off walls or objects and come back to you. Normally you don't notice these reflections when you are speaking because not all of the energy is reflected, and the delay is so short that your ears can't distinguish it from the original sound, but sometimes (such as in a very large open room) you can hear them - these are echoes! You hear an **echo** when a lot of the energy of your voice is reflected back to you after a noticeable delay. The delay time is the distance (to the reflection point and back) divided by the speed of sound. Most people cannot distinguish reflected sound waves with delays of less than 1/15 of a second, and perceive them as being part of the original sound. Echoes can be simulated electronically by replaying a recorded sound with a small delay and at reduced volume. See project 10 and others for examples.

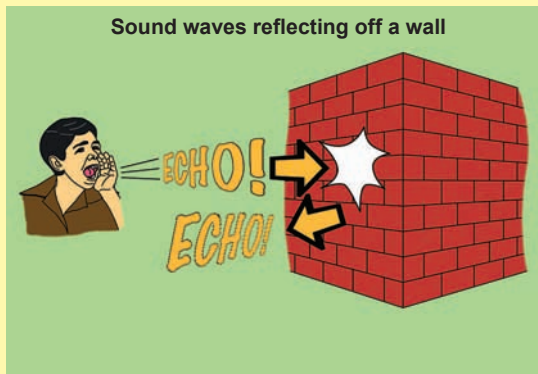

In project 10, if your speaker is too close to your microphone then the echo sound can be picked up by the microphone and echoed again and again until you can't hear anything else. The same thing can occur in telephone systems, and these systems sometimes have echo-cancelling circuitry to prevent problems (especially in overseas calls, where the transmission delay times may be longer).

Engineers developing sensitive audio equipment need to make very accurate sound measurements. They need rooms that are sealed from outside sounds, and need to minimize the measured signal's reflections off the walls/ceiling/floor. Specialized rooms have been designed for this, called **anechoic chambers**. These chambers are virtually soundproof and have specially shaped materials (usually made of foam) on the walls to absorb sound waves without producing any echoes. These chambers simulate a quiet, open space, allowing the engineers to accurately measure the equipment being tested.

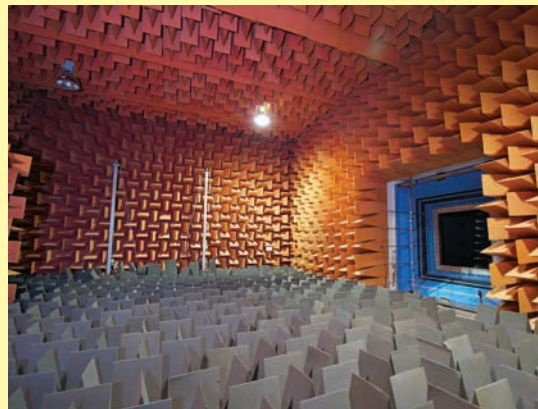

Anechoic chamber

Everything has a natural frequency, its **resonance frequency**, at which it will vibrate more easily. When sound waves strike an object at its natural frequency, the object can absorb and store significantly more energy from the sound waves, as vibration. To help understand this concept, think of a playground swing, which tends to always swing back and forth at the same rate. If you push the swing at the ideal moment, it will absorb energy from you and swing higher. You don't need to push the swing very hard to make it go high, you just

need to keep adding energy at the right moment. In project 13 (Sound Energy Demonstration), the frequency is tuned to the speaker's natural frequency, making it vibrate noticeably.

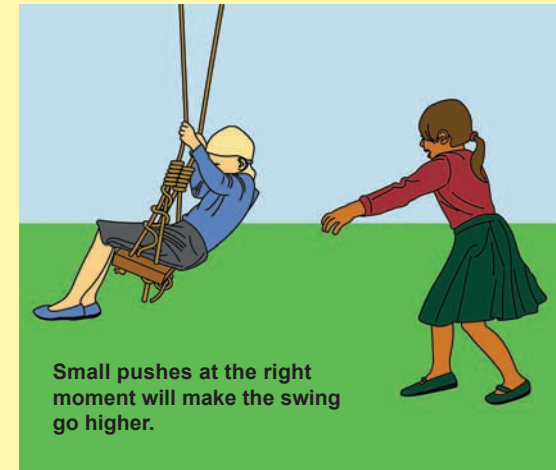

Resonance is an important consideration in the design of musical instruments, and also in construction. If high winds blow on a tall building or a bridge at the structure's resonant frequency, vibrations can slowly increase until the structure is torn apart and collapses.

A cone can help you project your voice. A **cone** keeps the sound waves (air pressure variations) together longer, so they don't spread out so quickly. Long ago, people who had trouble hearing used an **ear trumpet**, which helps collect sound waves. A person would speak into the wide end of the ear trumpet, and the trumpet makes the sound louder at the listening person's ear. Electronic hearing aids have replaced ear trumpets. Doctors use a **stethoscope** to hear inside patient's bodies. A stethoscope uses a cone-like structure to collect sound waves; then passes them into the doctor's ear.

Sound in Our World

Electronically we amplify sound by converting the sound waves into an electrical signal, amplify the electrical signal, and then convert that back to sound waves.



There are many other applications for sound waves. Here are some examples:

In **SONAR** (short for **S**ound **N**avigation **A**nd **R**anging), sound waves are sent out underwater at various frequencies and the echoes are measured; the distance to any objects can be determined using the time for the echoes to arrive, and the speed of sound. SONAR is used for navigating around underwater obstacles and for detecting other ships, especially submarines. SONAR is also used by the fishing industry to help find and harvest fish. Sound waves can also be used to determine the depth of an oil well. **RADAR** (**R**adio **D**etection **A**nd **R**anging) is similar to SONAR but uses radio waves instead of sound waves.

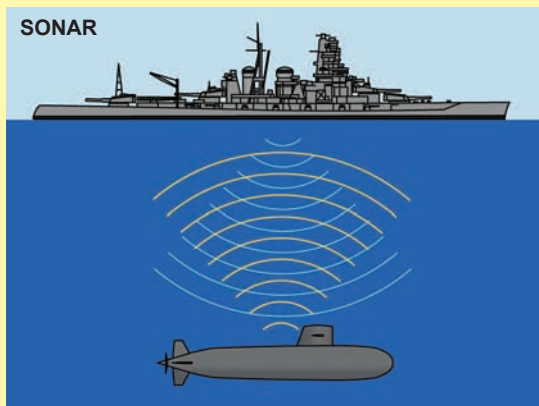

Ultrasound waves are above 20 kHz, beyond the range of human hearing. Bats use ultrasound waves to effectively “see” in the dark. Ultrasound waves are also used in medical imaging, to create pictures of muscles and organs in the human body. Ultrasound waves are sometimes used in cleaning items like jewelry.

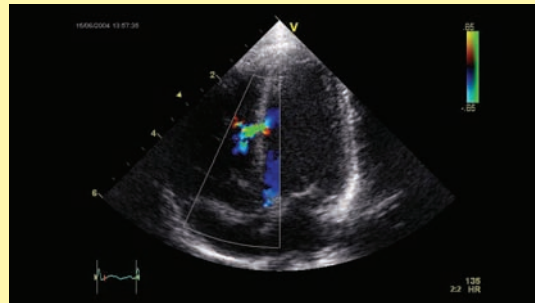

Ultrasound photo of a heart (echocardiogram)

Ultrasonic welding is used in industry to bond materials (usually plastics) together using high frequency sound waves. The energy of the sound waves is concentrated at the points to be bonded, and basically melts the material at the contact points. This can create a strong bond, without using glue or nails. Ultrasonic welding has been used to bond the bottoms of Snap Circuits® parts in the past, and might still be used for the speaker (SP2) and microphone (X1).

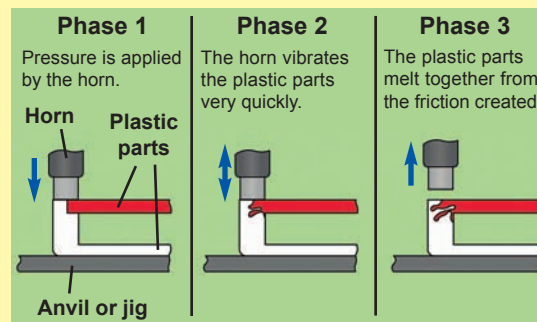

Ultrasonic welding

Earthquakes are compression waves, similar to sound waves but with enormous power. Using triangulation from several measurement points, and knowing how fast these waves can travel across the earth's surface, scientists can determine where the earthquake began (called the epicenter).

Music

The subject of music is one where the worlds of art and science come together. Unfortunately, the artistic/musician field works with qualities that depend on our feelings and so are difficult to express using numbers while science/engineering works with the opposite - clearly defined, measurable qualities. As a result, some of the terms used may seem confusing at first, but you will get used to them.

Music is when vibrations (creating sound waves) occur in an orderly and controlled manner forming a pattern with their energy concentrated at specific frequencies, usually pleasant to listen to. **Noise** is when the vibrations occur in an irregular manner with their energy spread across a wide range of frequencies, usually annoying to hear (static on a radio is a good example). Notice how some people refer to music that they don't like as noise. In electrical systems, noise is undesired interference that can obscure the signal of interest.

Another way to think of this is that the ear tries to estimate the next sounds it will hear. Music with a beat, a rhythm, and familiar instruments can be thought of as very predictable, so we find it pleasant to listen to. Notice also that we always prefer familiar songs to music that we are hearing for the first time. Sudden, loud, unpredictable sounds (such as gunfire, a glass breaking, or an alarm clock) are very

Sound in Our World

unnerving and unpleasant. Most electronic speech processing systems being developed use some form of speech prediction filters.

Take a piece of string or rope roughly 4 feet long and tie one end of it to a chair or other piece of furniture. Swing the other end up and down so that you have a cyclic pattern, as shown:

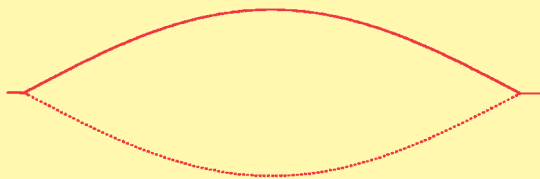

Now swing it three times as fast (three times the frequency), to produce this pattern:

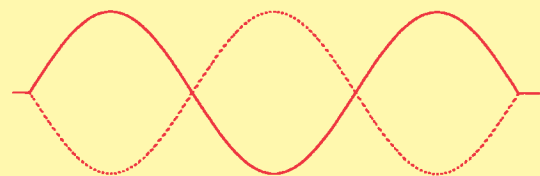

Now try to swing it five times as fast (five times the frequency), to produce this pattern:

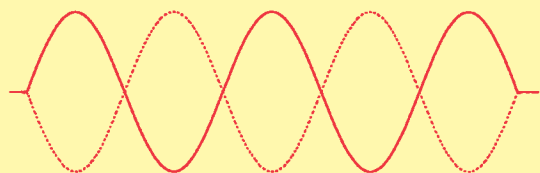

Since the later patterns are frequency multiples of the first, we refer to them as overtones (the music term) or harmonics (the electronics term) and the original pattern is called the fundamental. If you could combine all three of the above patterns onto the string then you would get a pattern, which looks like this:

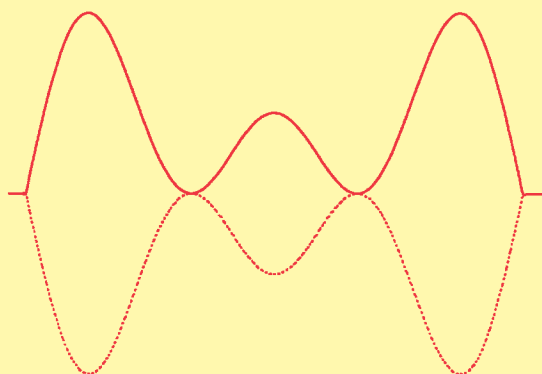

This combined pattern (a single fundamental with overtones) is called a tone (and a pure tone is a single fundamental with no overtones). Notice that each pattern is more difficult to produce than the one before it, with the combined pattern being quite complicated. And also notice that the more complicated patterns are much more interesting and pleasing to look at than the simpler ones. Well the same thing applies to sound waves. Complex patterns that have many overtones for each fundamental are more pleasant to listen to than simple patterns. If many overtones were combined together, the results would approximate a square wave shape.

All traditional music instruments use this principle, with the instrument shapes and materials perfected through the years to produce many overtones for each fundamental chord or key that is played by the user. Grand pianos sound better than upright pianos since their larger shape enables them to produce more overtones, especially at lower frequencies. Concert halls sound better than small rooms because they are designed for best overtone performance and to take advantage of the fact that sound waves can reflect off walls to produce different overtone

relationships between both of your ears. The same thing applies to stereo sound. You may have heard the term acoustics; this is the science of designing rooms for best sound effects.

A commonly used musical scale (which measures pitch) will now be introduced. This scale is called the equal temperament scale, expressed in hertz. You might think of this as a conversion table between the artistic and scientific worlds since it expresses pitch in terms of frequency. Each overtone (overtone 0 being the fundamental) is divided into 12 semitones: C, C# ("C-flat"), D, D#, E, F, F#, G, G#, A, A#, and B. The semitones increase by the ratio 12:2, or 1.05946. Musical notes (tones) are the measure of pitch and are expressed using both the semitone and the overtone, such as A3, G#4, D6, A#1, and E2.

(frequency in hertz and rounded off)

Overtone	C	C#	D	D#	E	F
0	16.4	17.3	18.4	19.4	20.6	21.8
1	32.7	34.6	36.7	38.9	41.2	45.7
2	65.4	69.3	73.4	77.8	82.4	87.3
3	130	139	147	156	165	175
4	262	278	294	311	330	349
5	523	554	587	622	659	698
6	1047	1109	1174	1245	1319	1397
7	2093	2217	2344	2489	2637	2794
8	4186	4435	4698	4978	5274	5588
9	8372	8870	9397	9956	10548	11175
Overtone	F#	G	G#	A	A#	B
0	23.1	24.5	26.0	27.5	29.1	30.9
1	46.2	49.0	51.9	55.0	58.3	61.7
2	92.5	98.0	104	110	117	123
3	185	196	208	220	233	247
4	370	392	415	440	466	494
5	740	784	831	880	932	988
6	1480	1568	1661	1760	1865	1976
7	2960	3136	3322	3520	3729	3951
8	5920	6271	6645	7040	7459	7902
9	11840	12542	13290	14080	14917	15804

Sound in Our World

On your U26 keyboard, the blue keys approximate the 5th overtone notes, and the green keys approximate the 6th overtone notes; actual frequency may vary from the musical scale. The tone of the green keys can be adjusted with the tune knob, allowing them to be in tune with the blue keys, or out of tune with them. The tone of the green keys may also be adjusted using external resistors and capacitors, which can change the frequency range dramatically (and even beyond the hearing range of your ears), and can create an optical theremin. Your keyboard can play one blue note and one green note at the same time; if you press two keys of the same color at the same time, only the higher note will be played. Projects 1-4 and 25-27 demonstrate the capabilities of the U26 keyboard.

On most instruments, when you play a note the sound produced is initially loud and then decreases with time. On your U26 keyboard, a note ends when you release the key, unless you connected external resistors to produce a continuous tone. More complex electronic instruments can simulate more notes at the same time, have more advanced techniques for producing overtones, and continue to play the note with decreasing loudness after the key has been released.

The musical world's equivalent to frequency is pitch. The higher the frequency, the higher the pitch of the sound. Frequencies above 2,000 Hz can be considered to provide treble tone. Frequencies about 300 Hz and below provide bass tone.

Up to now, the musical measures of pitch and loudness have been discussed. But many musical sounds have the same pitch and loudness and yet sound very different. For

example, the sound of a guitar compared to that of a piano for the same musical note. The difference is a quality known as timbre. Timbre describes how a sound is perceived, its roughness. Scientifically it is due to differences in the levels of the various overtones, and so cannot be expressed using a single number.

Now consider the following two tones, which differ slightly in frequency:

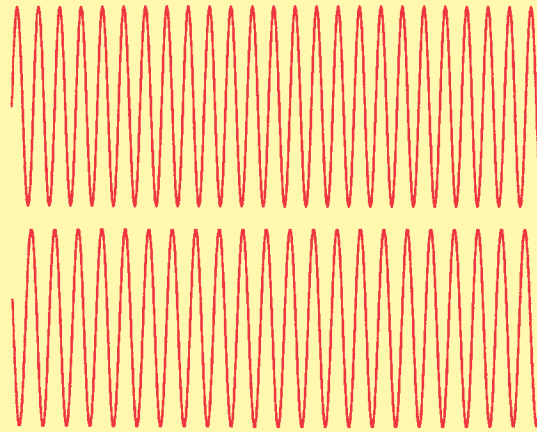

If they are played at the same time then their sound waves would be added together to produce:

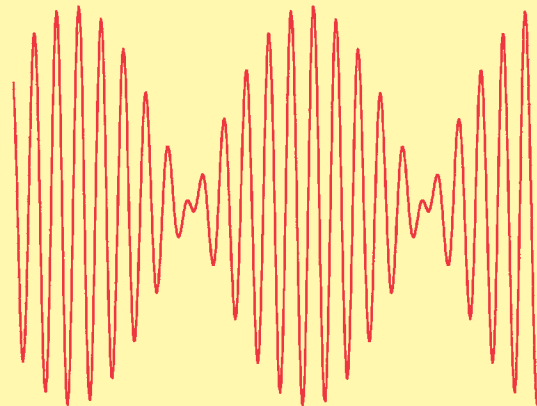

Notice that the combined wave has a regular pattern of where the two tones add together and where they cancel each other out. This is the effect that produces the beat you hear in music. Two tones (that are close in frequency and have similar amplitude for their fundamental and for each of their overtones) will beat at the rate of their frequency difference. Rhythm is the pattern of regular beat that a song has.

Now observe this tone:

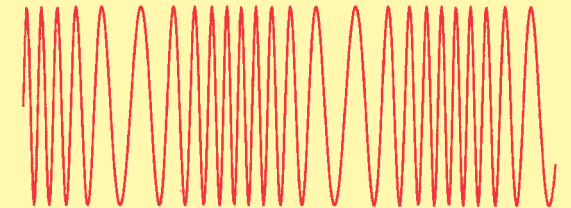

The frequency is slowly increasing and decreasing in a regular pattern. This is an example of vibrato. If the frequency is changing slowly then it will sound like a varying pitch; a fast vibrato (several times a second) produces an interesting sound effect. The alarm IC (U2, included in Snap Circuits[®] models SC-100, 300, 500, or 750) produces sounds using the vibrato effect.

Tempo is a musical term, which simply describes how quickly a song is played.

DO's and DON'Ts of Building Circuits

After building the circuits given in this booklet, you may wish to experiment on your own. Use the projects in this booklet as a guide, as many important design concepts are introduced throughout them. Every circuit will include a power source (the batteries), a resistance (which might be a resistor, capacitor, speaker, integrated circuit, etc.), and wiring paths between them and back. **You must be careful not to create "short circuits" (very low-resistance paths across the batteries, see examples at right) as this will damage components and/or quickly drain your batteries.** Only connect the keyboard (U26), voice changer (U27), and echo IC (U28) using configurations given in the projects, incorrectly doing so may damage them. **ELENCO® is not responsible for parts damaged due to incorrect wiring.**

Here are some important guidelines:

- ALWAYS** USE EYE PROTECTION WHEN EXPERIMENTING ON YOUR OWN.
- ALWAYS** include at least one component that will limit the current through a circuit, such as the speaker, capacitors, ICs (which must be connected properly), microphone, or resistors.
- ALWAYS** use LEDs, transistors, and switches in conjunction with other components that will limit the current through them. Failure to do so will create a short circuit and/or damage those parts.
- ALWAYS** connect capacitors so that the "+" side gets the higher voltage.
- ALWAYS** disconnect your batteries immediately and check your wiring if something appears to be getting hot.
- ALWAYS** check your wiring before turning on a circuit.
- ALWAYS** connect the keyboard (U26), voice changer (U27), and echo IC (U28) using configurations given in the projects or as per the connection description on pages 6 and 7.
- NEVER** connect to an electrical outlet in your home in any way.
- NEVER** leave a circuit unattended when it is turned on.
- NEVER** use headphones at high sound levels.

For all of the projects given in this book, the parts may be arranged in different ways without changing the circuit. For example, the order of parts connected in series or in parallel does not matter — what matters is how combinations of these sub-circuits are arranged together.

You are encouraged to tell us about new programs and circuits you create. If they are unique, we will post them with your name and state on our website at:

www.snapcircuits.net/learning_center/kids_creation
Send your suggestions to ELENCO®: elenco@elenco.com.

ELENCO® provides a circuit designer so that you can make your own Snap Circuits® drawings. This Microsoft® Word document can be downloaded from:

www.snapcircuits.net/learning_center/kids_creation
or through the www.snapcircuits.net website.

Examples of SHORT CIRCUITS - NEVER DO THESE!!!

Placing a 3-snap wire directly across the batteries is a SHORT CIRCUIT.

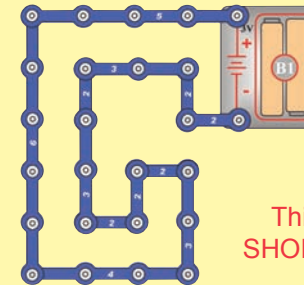
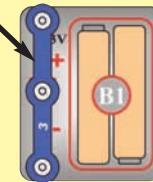

This is also a SHORT CIRCUIT.

When the slide switch (S1) is turned on, this large circuit has a SHORT CIRCUIT path (as shown by the arrows). The short circuit prevents any other portions of the circuit from ever working.

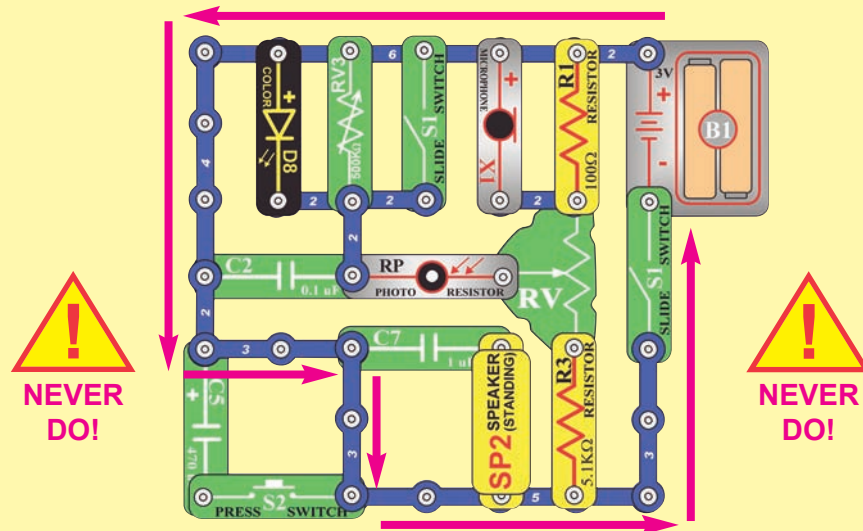

WARNING: SHOCK HAZARD - Never connect Snap Circuits® to the electrical outlets in your home in any way!



Warning to Snap Circuits® owners: Do not connect additional voltage sources from other sets, or you may damage your parts. Contact Elenco® if you have questions or need guidance.

Advanced Troubleshooting (Adult supervision recommended)

ELENCO® is not responsible for parts damaged due to incorrect wiring.

If you suspect you have damaged parts, you can follow this procedure to systematically determine which ones need replacing:

(Note: Some of these tests connect an LED directly across the batteries without another component to limit the current. Normally this might damage the LED, however Snap Circuits® LEDs have internal resistors added to protect them from incorrect wiring, and will not be damaged.)

- 1. Color LED (D8), speaker (SP2), and battery holder (B1):** Place batteries in holder. Place the color LED directly across the battery holder (LED + to battery +), it should light and be changing colors. “Tap” the speaker across the battery holder contacts; you should hear static as it touches. If neither works, then replace your batteries and repeat. If still bad, then the battery holder is damaged. Test both battery holders.
- 2. Red & black jumper wires:** Use this mini-circuit to test each jumper wire; the LED should light.

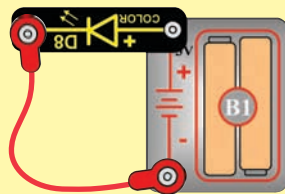

- 3. Snap wires:** Use this mini-circuit to test each of the snap wires, one at a time. The LED should light.

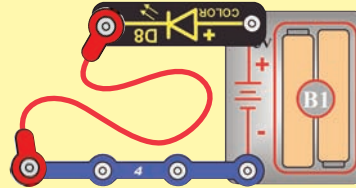

- 4. Slide switch (S1) and Press switch (S2):** Use this mini-circuit; if the LED doesn't light then the slide switch is bad. Replace the slide switch with the press switch to test it.

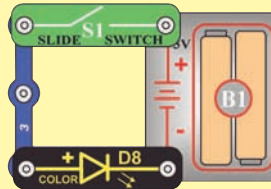

- 5. 100W (R1) and 5.1kW (R3) resistors, and microphone (X1):** Use this mini-circuit; the LED will be bright if the R1 resistor is good. Next use the 5.1kW resistor in place of the 100 W resistor; the LED should be much dimmer but still light. Next, replace 5.1kW resistor with the microphone (“+” to right); the LED should flicker dimly but still light.

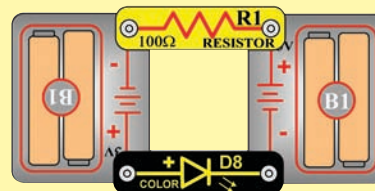

- 6. 500kW adjustable resistor (R V3) and Photoresistor (RP):** Use the mini-circuit from test 5 but replace the 100 W resistor with RV3. Turning RV3's knob all the way to the left (counter-clockwise) should make the color LED bright and most other settings should make the LED dim or off; otherwise RV3 is bad. Next, replace R V3 with the photoresistor, and shine a bright light on it. Waving your hand over the phototransistor (changing the light that shines on it) should change the brightness of the color LED; otherwise the photoresistor is bad.
- 7. Adjustable resistor (RV):** Build project 98. Move the resistor control lever to both sides. The color LED (D8) should be bright if the lever is to the far left or far right, and dim if the lever is in the middle.
- 8. NPN transistor (Q2):** Build the mini-circuit shown here. The color LED (D8) should only be on if the press switch (S2) is pressed. If otherwise, then Q2 is damaged.

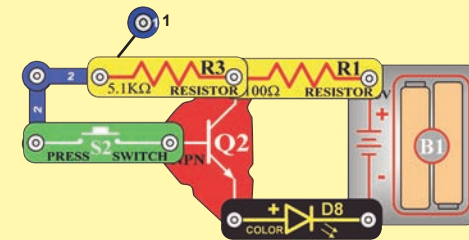

Advanced Troubleshooting (Adult supervision recommended)

9. **Keyboard (U26):** Build project 92, but omit the 0.1 mF capacitor (C2) and the 5.1kW resistor (R3). You should hear a tone when you press any key. Turning the TUNE knob while pressing any green key should change the tone slightly. Now add R3 to the circuit, and you should hear a continuous tone. If any of this does not work then the keyboard is damaged.

10. **0.1mF (C2), 1 mF (C7), and 470 mF (C5) capacitors:** Build project 92; removing C2 from it should change the tone, or C2 is damaged. Next, replace C2 with C7; the pitch of the tone should be lower now, or C7 is damaged. Next, replace C7 with C5; you should hear a click every few seconds, or C5 is damaged.

11. **Voice changer (U27):** Build project 7. Follow the project's instructions to confirm that you can make a recording and play it back at different speeds.

12. **Echo IC (U28):** Build the circuit shown at right, turn it on, and set the knob on the 500kW adjustable resistor (R V3) to the right. Press any keys on the keyboard; you should hear tones with echo, and be able to adjust echo level using the lever on the adjustable resistor (R V). Removing the 1mF capacitor (C7) should reduce the volume a little. Sometimes an echo IC problem can be fixed by turning the circuit off and back on to reset it.

12. **Audio Jack (JA) and stereo cable:** If you have headphones, use them to test the audio jack using project 14. If you have a music device, use it to test the audio jack using project 66. Use project 66 to test your stereo cable.

13. **Sound energy demonstration container:** If the flexible sheet is damaged, disassemble the container and replace the flexible sheet; this set may have included a spare for it, or you can use household plastic wrap.

ELENCO®
 150 Carpenter Avenue
 Wheeling, IL 60090 U.S.A.
 Phone: (847) 541-3800
 Fax: (847) 520-0085
 e-mail: help@elenco.com
 Website: www.elenco.com

You may order additional / replacement parts at: www.snapcircuits.net

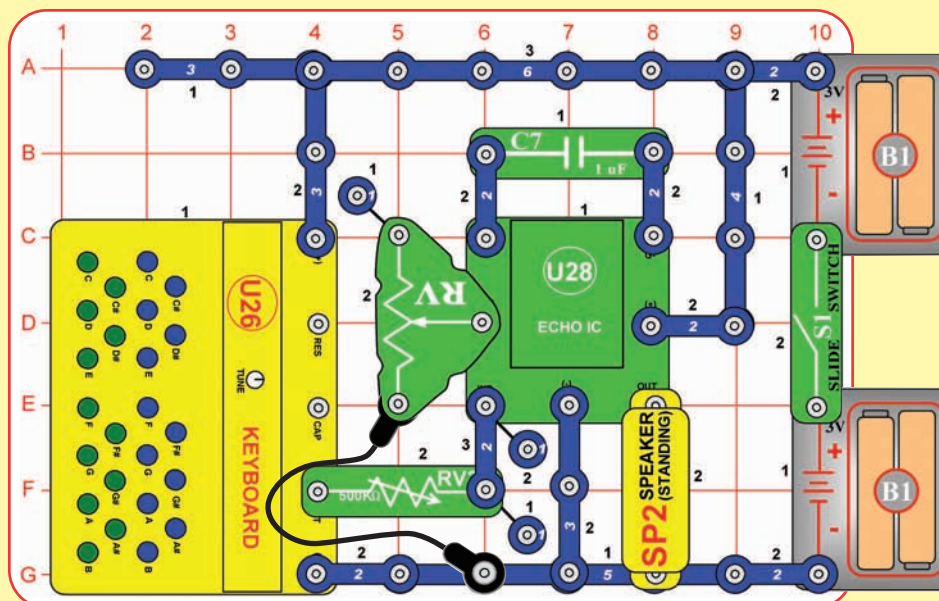

Project Listings

Project #	Description	Page #	Project #	Description	Page #	Project #	Description	Page #
1	Electronic Keyboard	20	32	Low Pitch Optical Keyboard Echo	33	63	Your Music without Echo	46
2	Aligning the Keyboard	20	33	Keyboard Echo with Stereo Effects	34	64	Low Power Your Music without Echo	46
3	Be a Musician	21	34	Optical Echo in Stereo	35	65	Adjustable Music without Echo	46
4	Be a Musician (II)	21	35	Color Short Light	35	66	L/R Music Amplifier	47
5	Optical Theremin	22	36	Keyboard with Optical Theremin	36	67	Another Transistor Amplifier	47
6	Keyboard Slider	22	37	Keyboard with Optical Theremin (II)	36	68	Microphone Resistance - LED	48
7	Voice Changer	23	38	Adjustable Dual Range Keyboard	36	69	Microphone Resistance - Audio	48
8	Voice Changer & Light	23	39	Adjustable Dual Range Keyboard (II)	36	70	Time Light	49
9	Color Light	23	40	Adjustable Dual Range Keyboard (III)	36	71	Time Light (II)	49
10	Echo	24	41	Your Music with Echo	37	72	Easier Adjust Time Light	49
11	Echo with Headphones	24	42	Your Music with Echo and Light	37	73	Small Adjust Time Light	49
12	Louder Echo with Headphones	24	43	Your Music Speed Changer	38	74	Day Light	50
13	Sound Energy Demonstration	25,26	44	Your Music Speed Changer (II)	38	75	Lower Day Light	50
14	Keyboard in Stereo	27	45	Your Music Speed Changer (III)	38	76	Dark Light	50
15	Optical Theremin in Stereo	27	46	Sound On Light	38	77	Blow Noise	50
16	Light & Sound	28	47	Super Optical Keyboard Echo	39	78	Listen to the Light Change	51
17	See Saw	28	48	Softer Optical Keyboard Echo	39	79	Adjustable Listen to the Light Change	51
18	Light, Sound, & Motion	29	49	Reflection Detector	39	80	Bright or Loud?	51
19	Brighter Light, Sound, & Motion	29	50	Super Optical Keyboard Echo for Headphones	40	81	LED Keyboard Control	52
20	Keyboard with Voice Changer	30	51	Sound is Air Pressure	41	82	LED Keyboard Control (II)	52
21	Optical Keyboard with Voice Changer	30	52	Sound is Air Pressure - Keyboard	41	83	Photo LED Keyboard Control	52
22	Keyboard Voice Changer & Light	30	53	Brightness Adjuster	42	84	Adjustable LED Keyboard Control	52
23	Voice Changer with Echo	31	54	Brightness Limiters	42	85	Capacitor Keyboard Control	53
24	Sound Controlled Light	31	55	Big Brightness Adjuster	42	86	Capacitor Keyboard Control (II)	53
25	Low Pitch Keyboard	32	56	Photo Brightness Adjuster	43	87	Voice & Keyboard Echo	53
26	Lower Pitch Keyboard	32	57	Amplified Photo Brightness Adjuster	43	88	LED Voice & Keyboard Echo	54
27	Very Low Pitch Keyboard	32	58	Amplified Big Brightness Adjuster	43	89	Photo LED Keyboard Echo	54
28	Echo Speed Changer	32	59	Cup & String Communication	44	90	Photo LED Keyboard	54
29	Keyboard Echo	33	60	Audio Amplifier	45	91	Audio Dark Light	54
30	Lower Pitch Keyboard Echo	33	61	Low Power Audio Amplifier	45	92	Oscillator	55
31	Optical Keyboard Echo	33	62	Audio Amplifier with L/R Control	45	93	Oscillator (II)	55

Project Listings

Project #	Description	Page #	Project #	Description	Page #	Project #	Description	Page #
94	Oscillator (III)	55	126	Daylight Voice Echo	63	158	Continuity Tester	73
95	Oscillator (IV)	55	127	Dark Voice Echo	64	159	High Low Light	73
96	Oscillator (V)	55	128	Dark Echo Light	64	160	Flicker Clicker	74
97	Oscillator (VI)	55	129	Dark Echo Variants	64	161	Fast Flicker Clicker	74
98	Left Right Bright Light	55	130	Day Echo Light	65	162	Slow Flicker Clicker	74
99	Adjustable Oscillator	56	131	Day Echo Variants	65	163	Timer Tone	74
100	Adjustable Oscillator (II)	56	132	Photo Light Timer	65	164	Little Battery	75
101	Adjustable Oscillator (III)	56	133	Adjustable Photo Light Timer	65	165	Tiny Battery	75
102	Adjustable Oscillator (IV)	56	134	Tone Stoppers	66	166	Little Battery Beep	75
103	Water Detector	56	135	Tone Stoppers (II)	66	167	Capacitors in Series	76
104	Clicker	57	136	Tone Stoppers (III)	66	168	Capacitors in Series (II)	76
105	Clicker with Echo	57	137	Tone Stoppers (IV)	66	169	Capacitors in Series (III)	76
106	3V Audio Amplifier	58	138	Tone Stoppers (V)	67	170	More Capacitors in Series	76
107	Mini Music Player	58	139	Alarm Light	67	171	Capacitors in Parallel	77
108	Voice Echo with Light	58	140	Voice Changer with Headphones	67	172	Capacitors in Parallel (II)	77
109	Color Sound	59	141	Day Keyboard	68	173	Capacitors in Parallel (III)	77
110	Color Sound (II)	59	142	Night Keyboard	68	174	More Capacitors in Parallel	77
111	Color Sound (III)	59	143	Color Keyboard	69	175	Resistors in Series	78
112	Backwards Color Sound	59	144	Color Keyboard (II)	69	176	Resistors in Parallel	78
113	White Light	60	145	Color Keyboard (III)	69	177	Lots of Resistors in Series	79
114	Red to White	60	146	Color Keyboard (IV)	69	178	Lots of Resistors in Parallel	79
115	Alarm	60	147	Color Keyboard (V)	70	179	Be a Loud Musician	80
116	Super Voice Echo with Light	61	148	Color Keyboard (VI)	70	180	Be a Loud Musician (II)	80
117	Press Echo	61	149	Adjustable Voice Changer & Light	70	181	Morse Code	81
118	Photo Echo	61	150	Adjustable Voice Changer & Light (II)	70	182	Transistor Audio Amplifier	82
119	Loud Press Photo Echo	61	151	Play Fast	71	183	Transistor Audio Amplifier (II)	82
120	Knob Echo	61	152	Red First	71	184	Make Your Own Parts	83
121	Echo Light Headphone	62	153	Adjustable Timer Tone	72	185	Color Touch Light	83
122	Echo Light Headphone Variants	62	154	Photo Timer Tone	72	186	Test Your Hearing	84
123	Press Echo Light	62	155	Delay Lamp	72	187	See the Sound	84
124	Photo Echo Light	62	156	Adjustable Delay Lamp	72	188	See the Spectrum	85
125	Another Voice Echo Light	63	157	Water Alarm	73			



Project 1

Electronic Keyboard

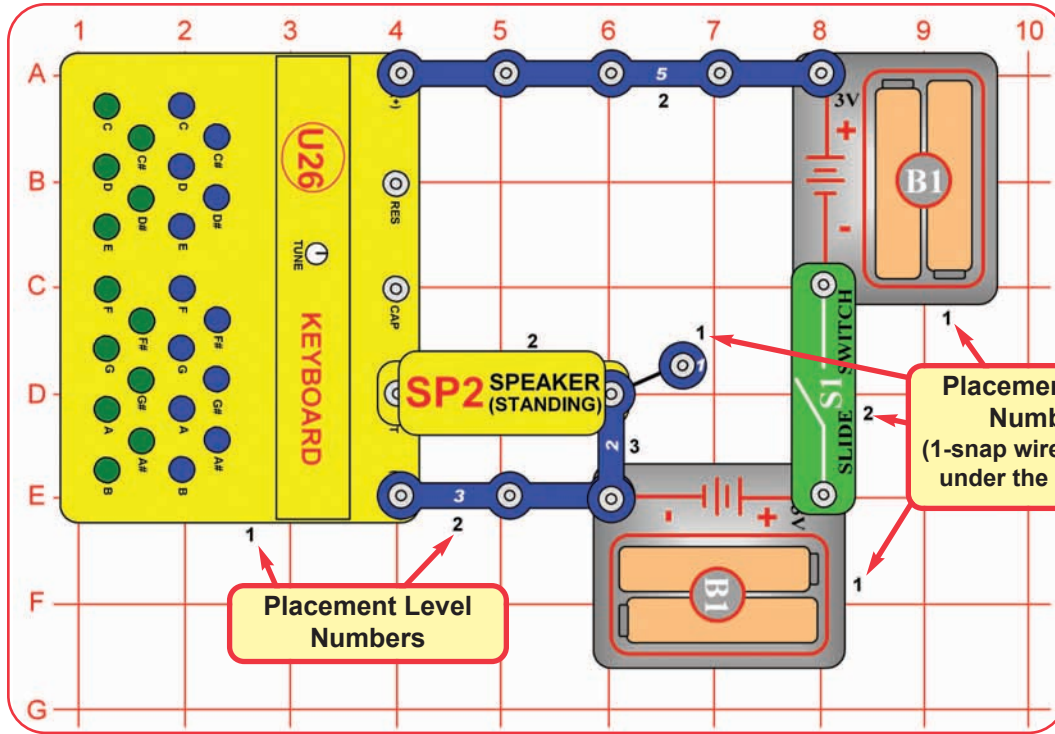

Snap Circuits® uses electronic blocks that snap onto a clear plastic grid to build different circuits. These blocks have different colors and numbers on them so that you can easily identify them.

Build the circuit shown on the left by placing all the parts with a black 1 next to them on the board first. Then, assemble parts marked with a 2. Then, assemble the part marked with a 3. Note that the 1-snap wire is placed beneath the speaker (SP). Install two (2) “AA” batteries (not included) into each of the battery holders (B1) if you have not done so already.

Turn on the slide switch (S1), and press any of the keys on the keyboard (U26) to hear tones. Two tones may be played at the same time, one tone from the blue keys and one tone from the green keys. If you press two keys of the same color then the higher pitch one will be played.



Project 2

Aligning the Keyboard

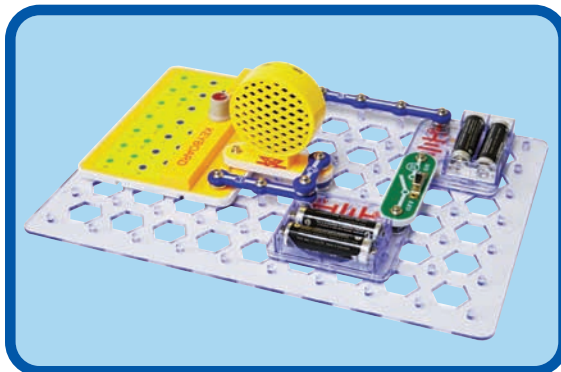

Use the preceding circuit. Press one of the green keys and turn the TUNE knob on the keyboard to adjust the pitch of the tone. The TUNE knob will not affect the blue keys.

Now turn the TUNE knob while pressing the blue C key and the green C key at the same time. Slowly turn the knob across its entire range, and see how the sound varies. At most TUNE knob positions you will notice separate tones from the blue and green keys, but there will be a knob position where the blue and green tones blend together and seem like a single musical note - this is the best TUNE setting to play songs with. The blue and green keys are now aligned together.

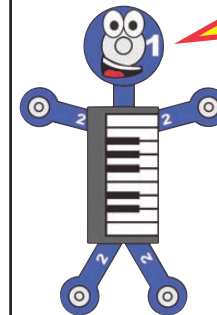

Snappy says the green keys have approximately double the pitch (frequency) of the blue keys. When the blue and green keys have been aligned using the TUNE knob, then they have (almost) exactly double the pitch, and sound good together because they are in harmony.



Project 3

Be a Musician

To play a song, just press the key corresponding with the letter shown. If there is a "-" after a letter, press the key longer than usual.

Mary Had a Little Lamb

E D C D E E E- D D D- E G G-

Ma-ry had a lit-tle lamb, Lit-tle lamb, lit-tle lamb.

E D C D E E E E D D E D C-

Ma-ry had a lit-tle lamb, Whose fleece was white as snow.

Row, Row, Row Your Boat

C- C- C D E- E D E F G-

Row, row, row your boat, Gen-tly down the stream.

C C C G G G E E E C C C G F E D C-

Mer-ri-ly, mer-ri-ly, mer-ri-ly, mer-ri-ly, Life is but a dream.

The Farmer in the Dell

-G C C C C C-D E E E E

The far-mer in the dell, The far-mer in the

E- G- GA G E C D E E D D C-

dell, Heigh-ho the der-ry-oh, the far-mer in the dell.

Muffin Man

D G G A B C G F# E A A G F# D D

Do you know the muf-fin man, The muf-fin man, the muf-fin man?

D G G A B G G G A A D D G-

Do you know the muf-fin man Who lives on Dru-ry Lane?

Twinkle, Twinkle, Little Star

C C G G A A G F F E E D D C-

Twin-kle, twin-kle, lit-tle star, How I won-der what you are.

G G F F E E D- G G F F E E D-

Up a-bove the world so high, Like a dia-mond in the sky.

C C G G A A G F F E E D D C-

Twin-kle, twin-kle, lit-tle star, How I won-der what you are.

Rain, Rain, Go Away

G E G G E G G E A G G E

Rain, rain, go a-way. Come a-gain some o-ther day.

F F D D D F F D G F E D E C C-

We want to go out-side and play. Rain, rain, go a-way.

For He's a Jolly Good Fellow

-C E E E D E F E E D D D C D

For he's a jol-ly good fel-low, For he's a jol-ly good

E C D E E E D E F-A A G G G F D C-

-

fel-low, For he's a jol-ly good fel-low, Which no-bo-dy can de-ny

Ring Around the Rosy

G G E A G E F G G E A G E

Ring a-round the ro-sy, A poc-ket full of pos-ies,

F D F D F G G C-

Ash-es, ash-es, We all fall down!

Mystery song (see if you recognize it)

C C D C F E-

C C D C G F-

C C A F F E

A# A# A F G F-

Some songs have been modified to make them easier to play on your keyboard.



Project 4 Be a Musician (II)

Use the preceding circuit and songs, but press both the blue and green keys for each note, at the same time. Try this with the blue and green keys aligned (as per project 2), but also try them at different TUNE knob settings (so the keys are out of alignment).



Project 5

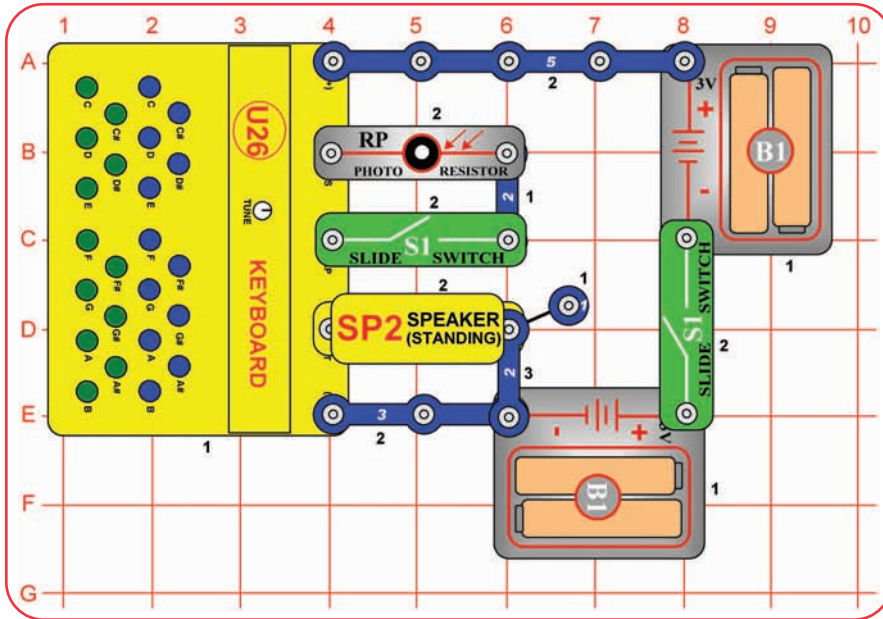

Optical Theremin

Build the circuit as shown. Turn on both slide switches (S1), and move your hand over the photoresistor (RP). You can adjust the sound just by moving your hand around. See what range of sounds you can produce, then change the amount of light in the room, and see how sound the range of sounds has changed. There may not be any sound if there is too much or too little light on the photoresistor.

You can play the keyboard (U26) keys while adjusting the sound using the photoresistor, to get a combination of sound effects. Turn off the left slide switch to disable the photoresistor sound effects.

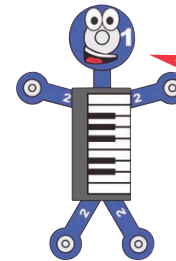

A theremin is an electronic musical instrument where you change the sound by moving your hands around near it (without touching it); using the tiny changes your hands have on the electromagnetic field of an antenna. This circuit is an optical theremin because instead you adjust the sound by changing the amount of light reaching a photosensor (the photoresistor).



Project 6

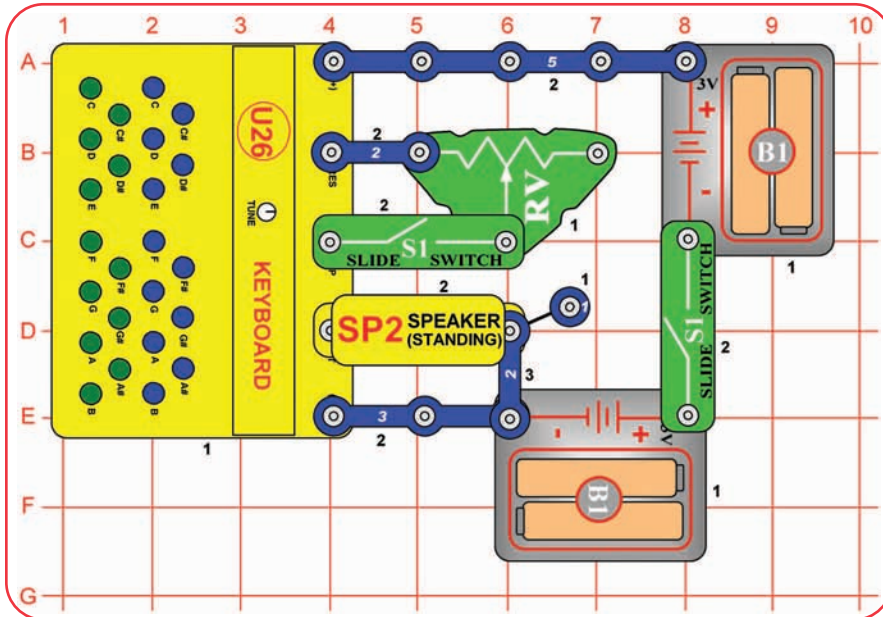

Keyboard Slider

Modify the preceding circuit to match this one. Turn on both slide switches (S1), and move the lever on the adjustable resistor (RV) around to change the sound. At some settings there may not be any sound.

You can play the keyboard (U26) keys while changing the sound with the adjustable resistor, to get a combination of sound effects. Turn off the left slide switch to disable the adjustable resistor sound effects.



Project 7

Voice Changer

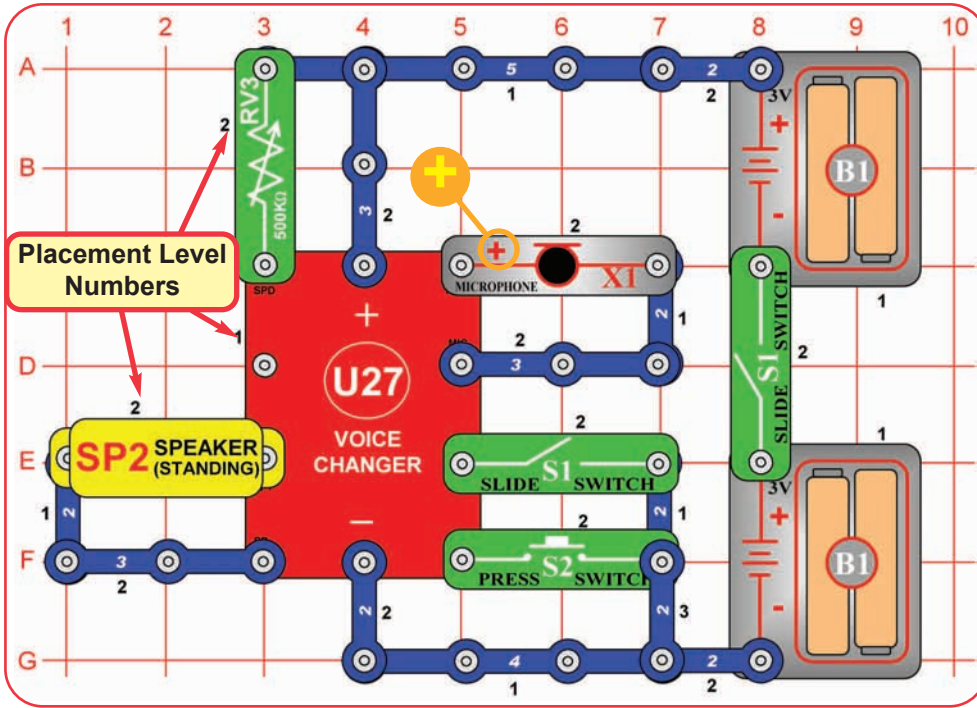

Build the circuit shown on the left by placing all the parts with a black **1** next to them on the board first. Then, assemble parts marked with a **2**. Then, assemble the part marked with a **3**. Install two (2) "AA" batteries (not included) into each of the battery holders (B1) if you have not done so already. Be sure to install the microphone (X1) with its "+" side positioned as shown.

Set the 500kΩ adjustable resistor (RV3) to mid-range, turn OFF the left slide switch (S1), and then turn on the right slide switch. Now turn on the left slide switch, you hear a beep signaling that you may begin recording. Talk into the microphone until you hear a beep (signaling that recording time is over), then turn off the left slide switch to exit recording mode. Push the press switch (S2) to play back the recording, and turn the knob on R V3 to change the playback speed. You can play your recording faster or slower by changing the setting on RV3.

Recording time is 6 seconds at normal speed, but this can be changed depending on the setting of RV3 when you are making the recording.



Project 8 Voice Changer & Light

Use the preceding circuit, but replace the 3-snap wire that is next to the speaker (SP2) with the color LED (D8, "+" to the left). Now when you press S2 to play the recording, the sound will not be as sound, but the color LED will be flashing.

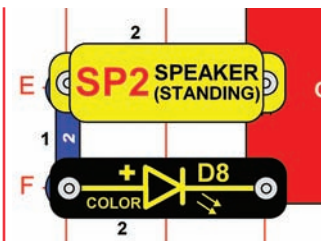

Project 9

Color Light

Build the circuit as shown. Turn on the slide switch (S1), and enjoy the light show from the color LED (D8). For best effects, place the egg LED attachment on the color LED, and dim the room lights.

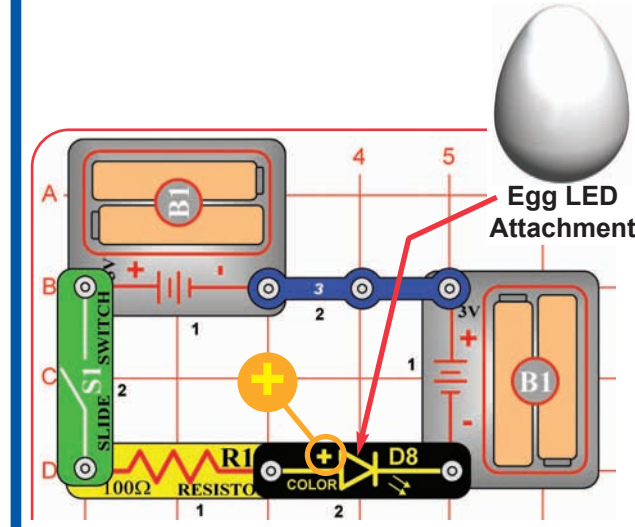

LEDs (Light Emitting Diodes) convert electrical energy into light; the color of the light emitted depends on the characteristics of the material used in them. The color LED actually contains separate red, green, and blue lights, with a micro-circuit controlling them.

Project 10

Echo

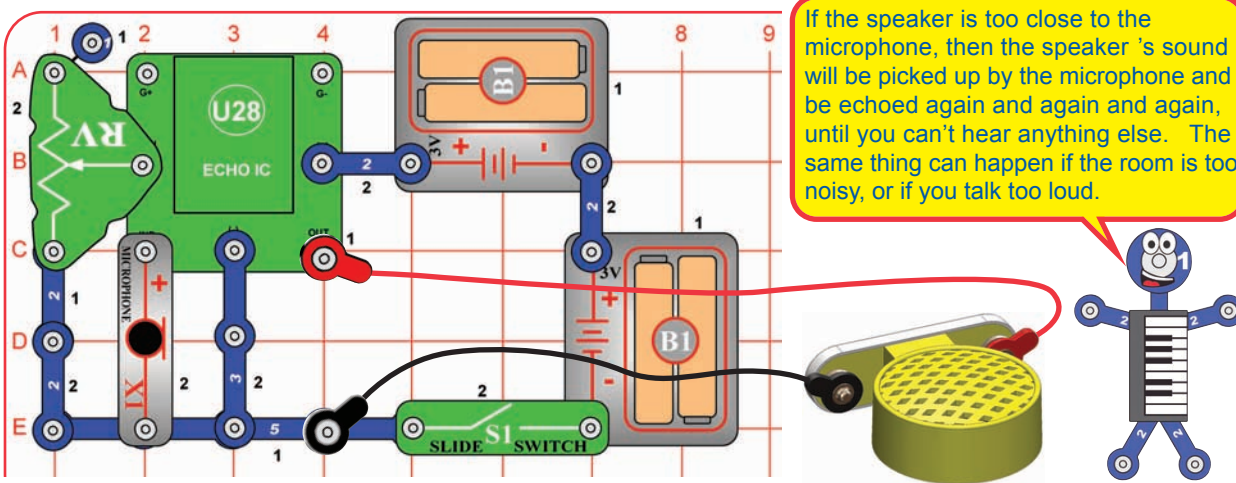

If the speaker is too close to the microphone, then the speaker's sound will be picked up by the microphone and be echoed again and again and again, until you can't hear anything else. The same thing can happen if the room is too noisy, or if you talk too loud.

Build the circuit as shown, and place it in a quiet room. Connect the speaker (SP2) using the red & black jumper wires, and then hold it away from the microphone (X1). Turn on the slide switch (S1). Talk into the microphone, and listen the echo on the speaker. Adjust the amount of echo using the lever on the adjustable resistor (RV); move the lever up for more echo or down for less echo. Try this at different RV settings, because the effects are very interesting with both high and low echo amounts. Also try it while saying different words/sounds.

Note: you must hold the speaker away from the microphone or the circuit may self-oscillate due to feedback. You also need a quiet room, with low background noise.

Project 11 Echo with Headphones

Project 12 Louder Echo with Headphones

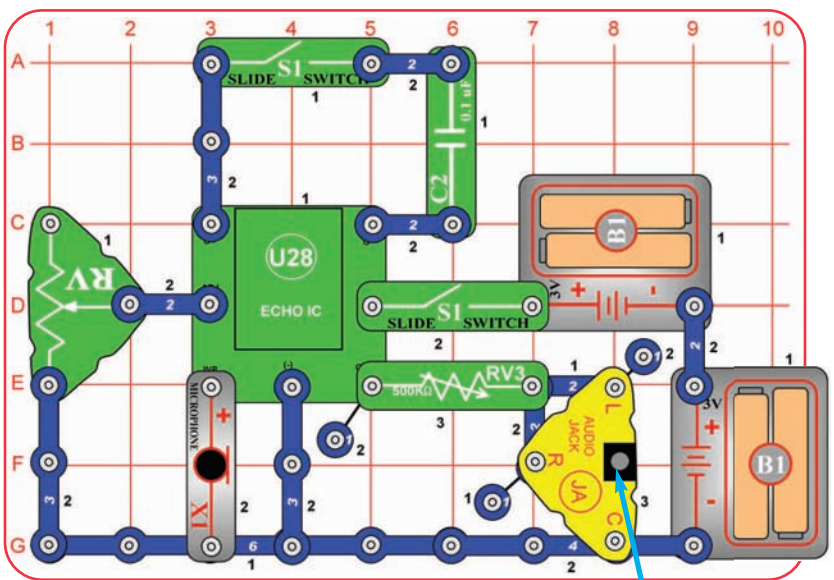

Build the circuit as shown, and connect your own headphones (not included in this set) to the audio jack (JA). Turn on the bottom slide switch (S1). Talk into the microphone, and listen the echo on your headphones. Set the 500kΩ adjustable resistor (RV3) for most comfortable sound level (turn to the left for higher volume, most of RV3's range will be very low volume), then adjust the amount of echo using the lever on the adjustable resistor (RV); move the lever up for more echo or down for less echo. Try this at different RV settings, because the effects are very interesting with both high and low echo amounts. Also try it while saying different words/sounds.

Turn on the top slide switch to make the sound louder, or turn it off to make the sound softer.

WARNING: Headphones performance varies, so use caution. Start with low volume, and then carefully increase to a comfortable level. Permanent hearing loss may result from long-term exposure to sound at high volumes.

Headphones (not included)

Turning on the top slide switch adds the 0.1mF capacitor (C2) to the circuit, which increases the amplification in the echo IC. With headphones, the sound can be made louder because the microphone does not pick it up easily.

Use the preceding circuit, but replace the 0.1 mF capacitor (C2) with the 1 mF capacitor (C7). The sound is louder now when both slide switches (S1) are on.

If you hold your headphones next to the microphone (X1), you may hear a whining sound, because the headphones sound might be picked up by the microphone and be echoed again and again and again.

Project 13

Sound Energy Demonstration

Assemble the Sound energy demonstration container (as per page 4, or shown on next page) if you have not done so already. Build the circuit as shown. Turn off the left slide switch (S1) and turn on the right slide switch. Lay the speaker (SP2) down on the unused 3-snap and 6-snap wires (to elevate it slightly off the table); be sure it is lying flat, and place the sound energy demonstration container over it. Pour some salt, glitter, small foam or candy balls of 0.1 inch diameter or less (not included) or similar into the container, but not enough to cover the bottom.

Press the keys on the keyboard to make sound. For some keys the salt/glitter/balls will vibrate and bounce or dance around in the container, find the key that gives the best effects. Most keys will create little or no vibration. For the best key, adjust the TUNE knob on the keyboard for best effects.

Now turn on the left slide switch and move the lever on the adjustable resistor (RV) around. At some positions the salt/glitter/balls will vibrate and bounce or dance around in the container; find the setting that gives the best effects. Press some keyboard keys to add more sound effects.

Experiment with different materials in the container and see which give the most impressive results. Our engineers found that nonpareils (round decorative candy sprinkles) of up to 0.1" work best.

Try lifting the container a little higher above the speaker with your hands, and see how much this affects the bounce height; see where you get the best effects. Try it at best key or R V setting, and at other keys/settings. Also, placing the speaker directly on the table (without the 3-snap and 6-snap under it) should reduce the vibration a little, but you can try it to see the difference.

Try removing the 0.1 mF capacitor (C2), and see how the sounds and bounce effects change. Next, remove the sound energy demonstration container from the speaker and instead lay your hand on it for the best setting, you can feel the speaker vibrate.

Don't eat anything you placed into the sound energy demonstration container.

The bouncing salt/glitter/balls show that sound has energy! Typically the E keys and the keys near them give the best effects, but your results may vary.

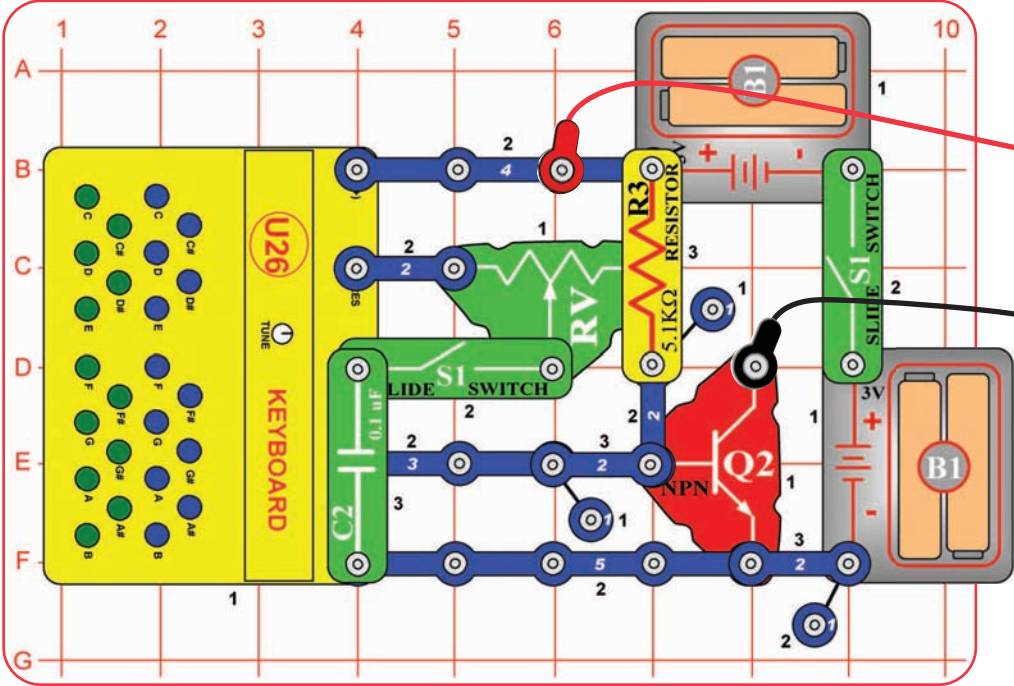
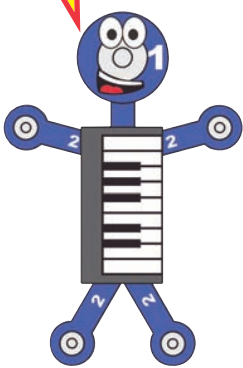

Pour salt, glitter, or small foam/candy balls (not included) into the container, but do not cover the bottom.

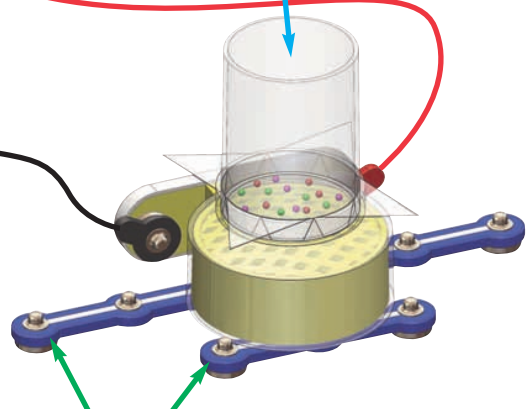

Lay the speaker on the extra 3-snap and 6-snap wires, to elevate it. Be sure speaker lays flat.

Part B: Optical Version

Modify the circuit to be this one, which has the photoresistor (RP) instead of the adjustable resistor (RV).

Turn on both slide switches and wave your hand over the photoresistor (RP), to change how much light shines into it. The sound changes as your hand adjusts the light. At some hand positions the salt/glitter/balls will vibrate and bounce or dance around in the container; find the hand position that gives the best effects. Press some keyboard keys to combine their sounds with the photoresistor sound. Try moving to an area with more or less light, and wave your hand over the photoresistor again.

Don't eat anything you placed into the sound energy demonstration container.

How does this work? There is a small range of frequency at which the sound waves resonate with the mechanical construction characteristics of the speaker, and cause the speaker to vibrate noticeably. The speaker's vibration creates changes in air pressure. The sound energy demonstration container covers the speaker and traps the air pressure changes, which then push/pull the flexible sheet up/down quickly, making the salt/glitter/balls bounce. Raising the speaker and container by placing them on the snap wires (or holding them) makes the vibrations more noticeable, because otherwise the table can dampen the vibrations.



Sound Energy Demonstration Container Assembly

(Adult supervision recommended)

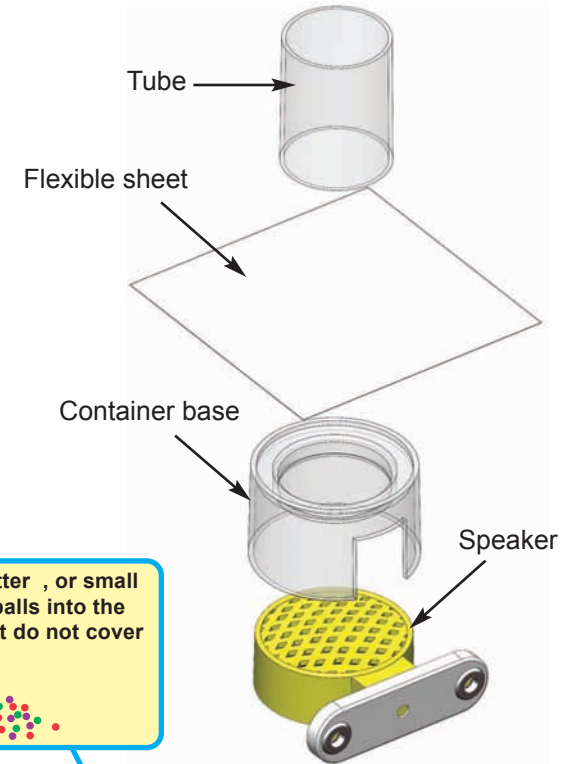

Pour salt, glitter, or small foam/candy balls into the container, but do not cover the bottom.

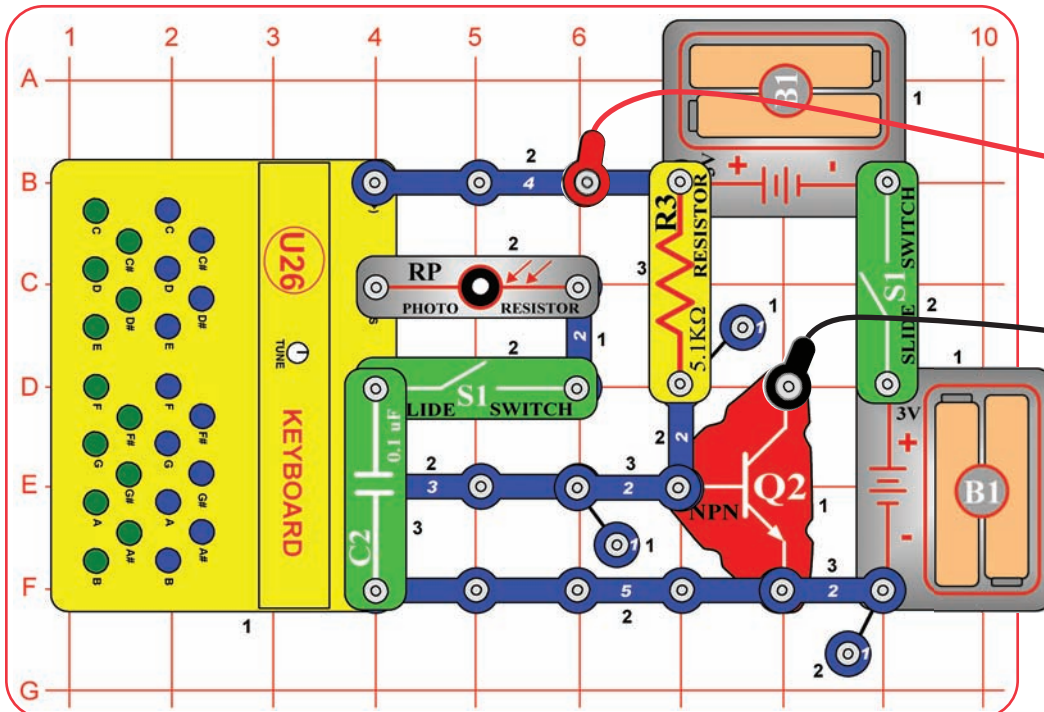

Lay the speaker on the extra 3-snap and 6-snap wires, to elevate it. Be sure speaker lays flat.



Project 14

Keyboard in Stereo

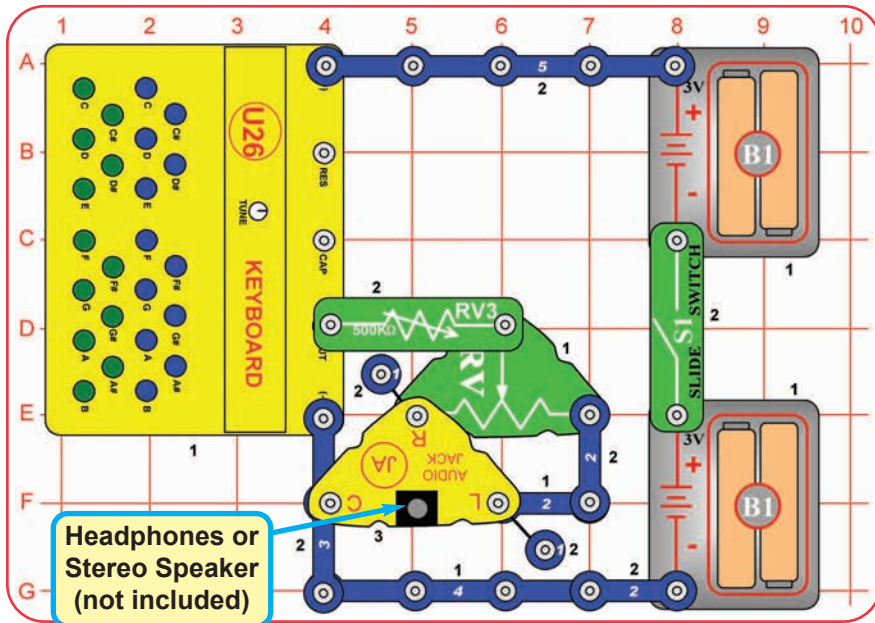

This project requires stereo headphones or a stereo speaker; neither is included with this set, but this set does include a stereo cable to facilitate connection to your stereo speaker.

Build the circuit as shown. Connect your own headphones or stereo speaker to the audio jack (JA). Turn on the slide switch (S1).

Press keys on the keyboard (U26) and listen to the sound on your headphones or stereo speaker. Set the 500kΩ adjustable resistor (RV3) for most comfortable sound level (turn to the left for higher volume, most of RV3's range will be very low volume), and then move the lever on the adjustable resistor (R V) to vary the amplitude to each ear.

WARNING: Headphones performance varies, so use caution. Start with low volume, then carefully increase to a comfortable level. Permanent hearing loss may result from long-term exposure to sound at high volumes.

In stereo, sound is produced on several speakers with varying amplitude on each. This gives the impression that the sound is coming from different directions.



Project 15

Optical Theremin in Stereo

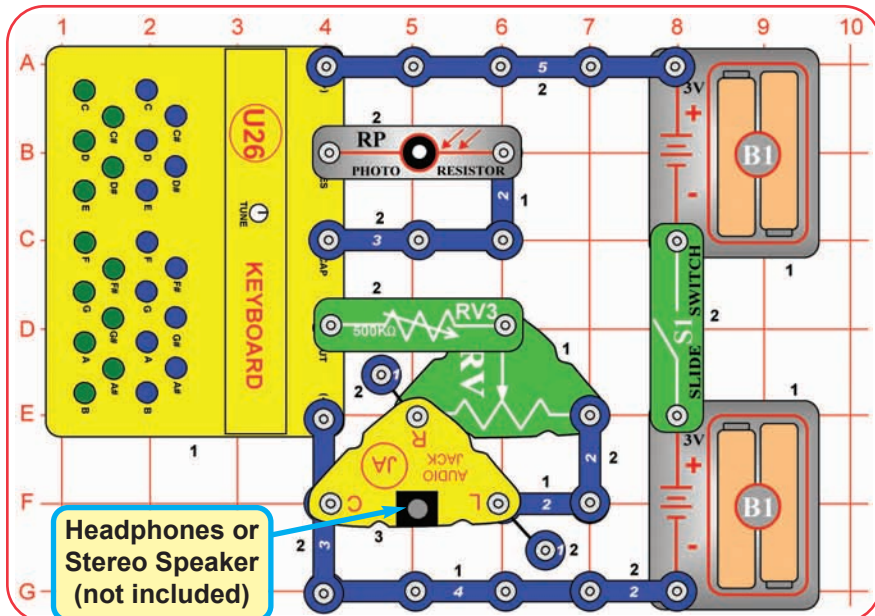

Use the preceding circuit, but modify it by adding the photoresistor (RP) and the parts next to it.

Press keys on the keyboard (U26) and wave your hand over the photoresistor (to adjust the amount of light shining on it) while listening to the sound on your headphones or stereo speaker. Set the 500kΩ adjustable resistor (RV3) for most comfortable sound level (turn to the left for higher volume, most of RV3's range will be very low volume), and move the lever on the adjustable resistor (RV) to vary the amplitude to each ear. There may not be any sound if there is too much or too little light on the photoresistor.

Close your eyes and have a friend vary the light to the photoresistor and moving the lever on the adjustable resistor. See if you get an impression of the sound changing direction.

WARNING: Headphones performance varies, so use caution. Start with low volume, then carefully increase to a comfortable level. Permanent hearing loss may result from long-term exposure to sound at high volumes.



Project 16

Light & Sound

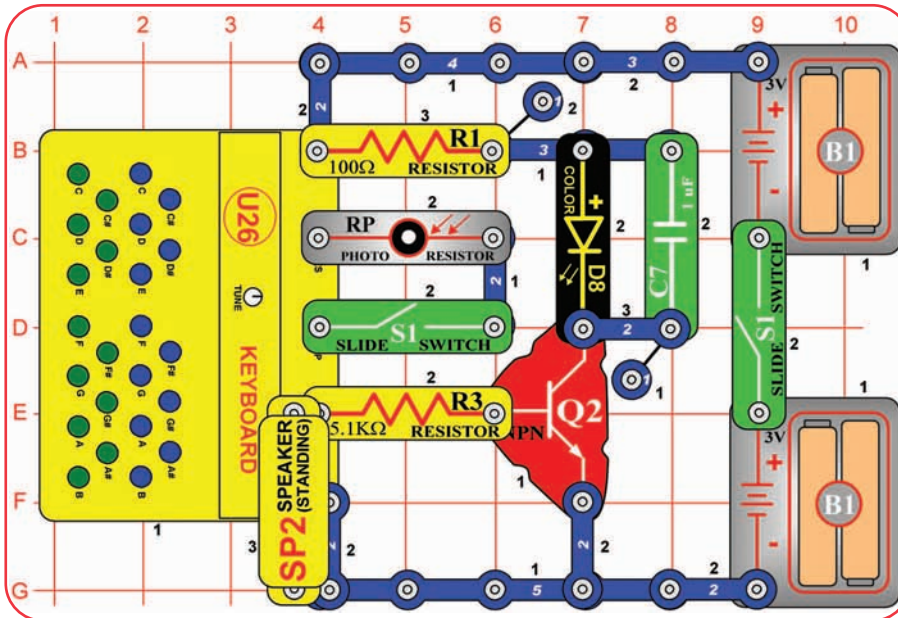

Build the circuit as shown; note that a 2-snap wire is placed directly under the speaker (SP2). Turn off the left slide switch (S1) and turn on the right slide switch. Press keys on the keyboard (U26) to make sound on the speaker (SP2) and light on the color LED (D8). If you hold a key down then the color LED will change colors.

Now turn on the left slide switch. If there is light on the photoresistor (RP), or if you press keys on the keyboard, then there will be sound from the speaker and light from the color LED. Wave your hand over the photoresistor to change the sound, or turn off left S1 to disable photoresistor control. Holding a key down will also make the color LED change colors.



Project 17

See Saw

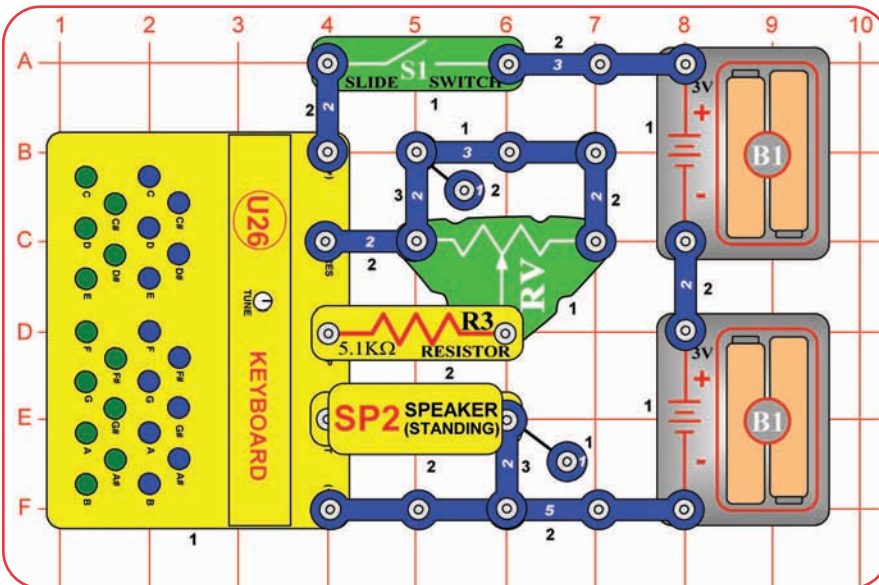

Turn on the slide switch (S1), and move the lever on the adjustable resistor (RV) around. The pitch of the sound will be lowest with the lever in the middle position, and higher with it set to the left or right.

You can replace the 5.1kΩ resistor (R3) with the 100kΩ resistor (R1) or 500kΩ adjustable resistor (RV3), but there may be no sound at some settings.



Project 18

Light, Sound, & Motion

Let's add motion to the preceding circuit. Modify the circuit to match this one. Turn off the left slide switch (S1) and turn on the right slide switch. Lay the speaker (SP2) down on unused 2-snap and 6-snap wires (to elevate it slightly off the table), be sure it is laying flat, and place the sound energy demonstration container over it (the container should have been assembled as per instructions on page 4). Pour some salt, glitter, small foam or candy balls of 0.1 inch diameter or less (not included) or similar into the container, but not enough to cover the bottom.

Press the keys on the keyboard to make sound and light the color LED (D8). For some keys the salt/glitter/balls will vibrate and bounce or dance around in the container, find the key that gives the best effects. Most keys will create little or no vibration. For the best key adjust the TUNE knob on the keyboard for best effects. The color LED will not be very bright.

Now turn on the left slide switch and wave your hand over the photoresistor (RP), to change how much light shines into it. The sound changes as your hand adjusts the light, and the color LED will light if there is bright light on the photoresistor. At some hand positions the salt/glitter/balls will vibrate

and bounce or dance around in the container; find the hand position that gives the best effects. Press some keyboard keys to combine their sounds with the photoresistor sound. Try moving to an area with more or less light, and wave your hand over the photoresistor again.

Experiment with different materials in the container and see which give the most impressive results. Our engineers found that 0.1" round non pareils (decorative candy sprinkles) work best.

Try lifting the container a little higher above the speaker with your hands, and see how much this affects the bounce height; see where you get the best effects. Try it at best key or R V setting, and at other keys/settings. Also, placing the speaker directly on the table (without the 3-snap and 6-snap under it) should reduce the vibration a little, but you can try it to see the difference.

Add the 0.1 mF capacitor (C2) over the keyboard (U26) at base grid locations D4-F4 (on level 3) and see how the circuit changed, especially when pressing the green keys.

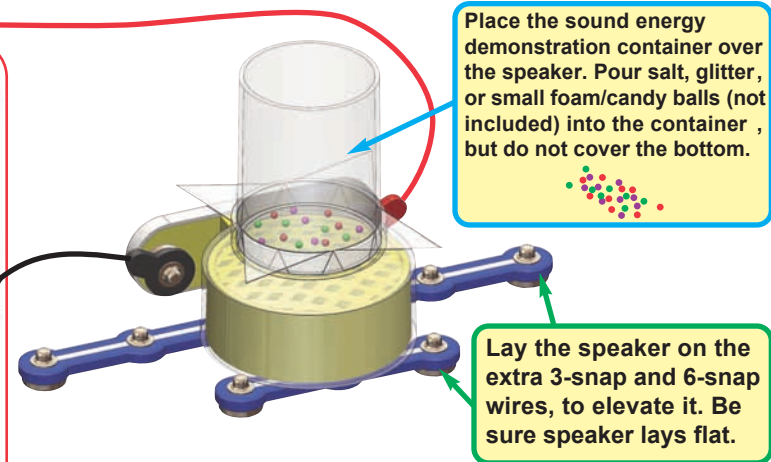
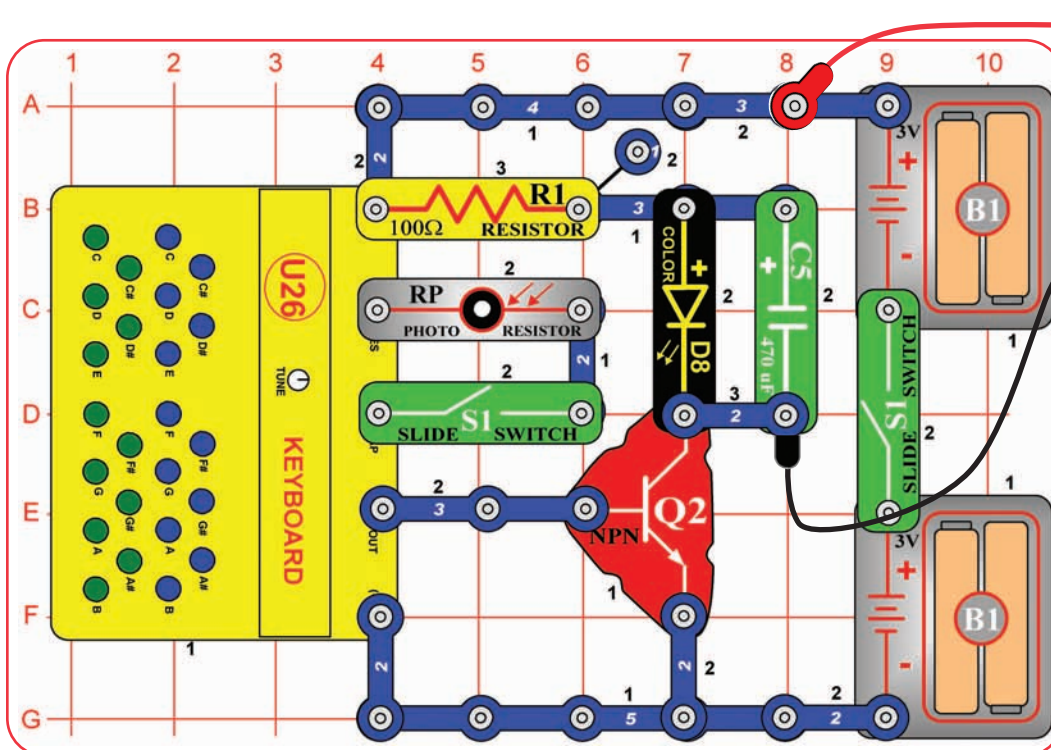

Project 19 Brighter Light, Sound, & Motion

Use the preceding circuit, but replace the 470 mF capacitor (C5) with the 1 mF capacitor (C7). The color LED (D8) is brighter now, but may not be changing colors.



Project 20

Keyboard with Voice Changer

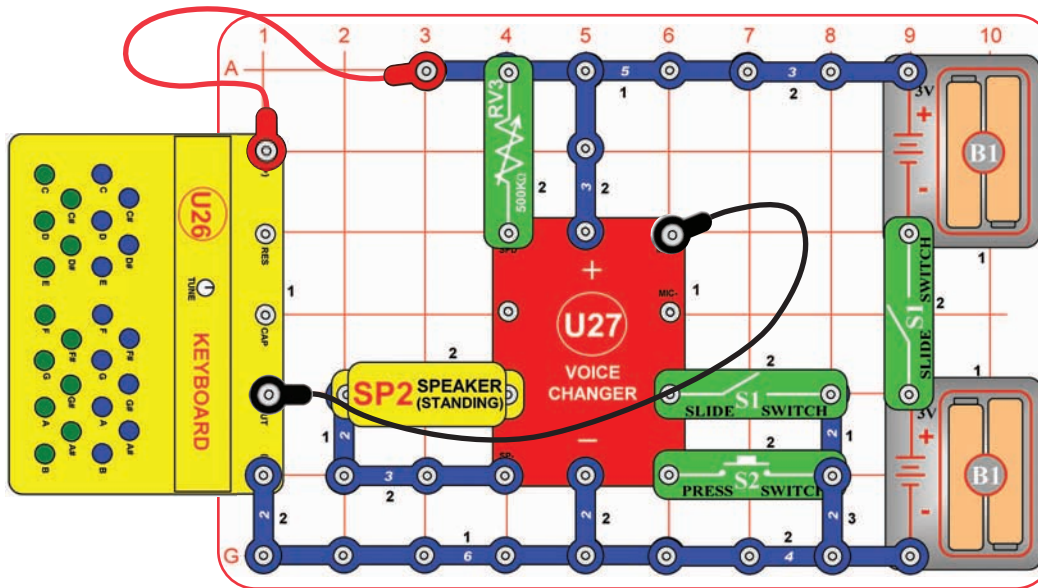

Set the 500kΩ adjustable resistor (RV3) to mid-range, turn OFF the left slide switch (S1), and then turn on the right slide switch. Now turn on the left slide switch, you hear a beep signaling that you are recording. Press keys on the keyboard (U26) until you hear a beep (signaling that recording time is over), then turn off the left slide switch to exit recording mode. Push the press switch (S2) to play back the recording, and turn the knob on RV3 to change the playback speed. You can play your recording faster or slower by changing the setting on RV3.

The keyboard overhangs the base grid, so be sure the connections to it stay secure as you are pressing keys.

Recording time is 6 seconds at normal speed, but this can be changed depending on the setting of RV3 when you are making the recording. You won't hear the notes when you are pressing the keys during recording; you only hear them during playback.



Project 21

Optical Keyboard with Voice Changer

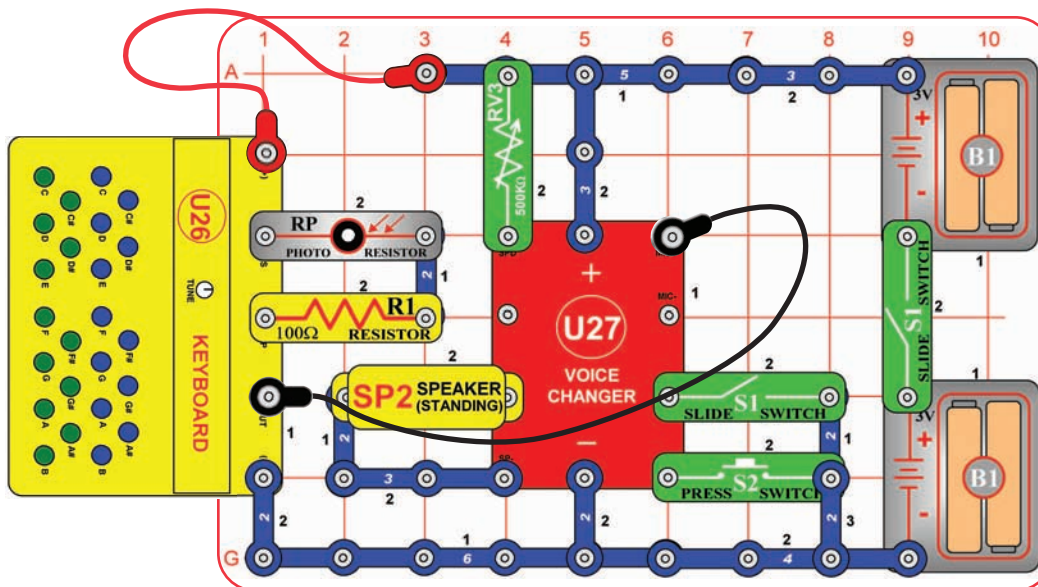

This circuit is similar to the preceding one, but adds optical control. Modify the preceding circuit by adding the photoresistor (RP) and the parts next to it.

When making your recording, wave your hand over the photoresistor to change the sound recorded, in addition to pressing keys. The photoresistor may have no effect if there is too much or too little light on it, so adjust the light on it if necessary.



Project 22 Keyboard Voice Changer & Light

Use either of the preceding circuits, but replace the 3-snap wire that is next to the speaker (SP2) with the color LED (D8, "+" to the left). Now when you press S2 to play the recording, the sound will not be as sound, but the color LED will be flashing.

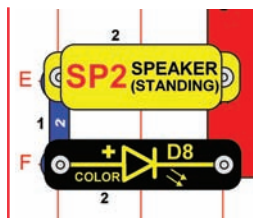



Project 23

Voice Changer with Echo

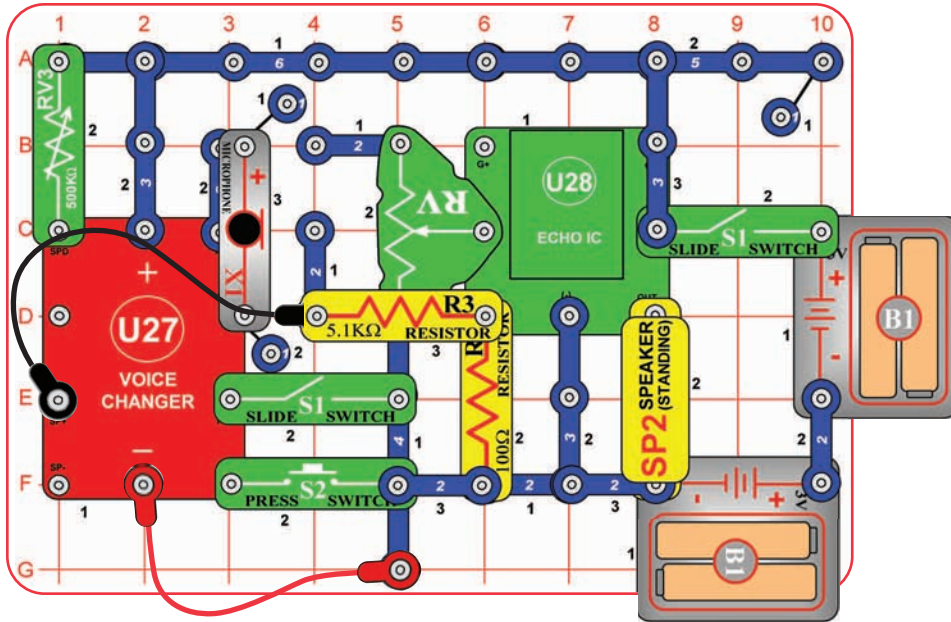

Build the circuit as shown; note that the microphone (X1) is covering a 2-snap wire, and that the 5.1k W resistor (R3) is a tight fit over the adjustable resistor (RV) but does fit. Set the 500kΩ adjustable resistor (RV3) to mid-range, set the adjustable resistor (RV) lever towards R3, turn OFF the left slide switch (S1), and then turn on the right slide switch.

Now turn on the left slide switch, you hear a beep signaling that you are recording. Talk into the microphone (X1) until you hear a beep (signaling that recording time is over), then turn of the left slide switch to exit recording mode. Now move the lever on RV to set the echo level, turn the knob on RV3 to change the playback speed, and push the press switch (S2) to play back the recording. You can play your recording faster or slower by changing the setting on R V3, and with more or less echo by changing the setting on RV.

Recording time is 6 seconds at normal speed, but this can be changed depending on the setting of RV3 when you are making the recording. RV should be set for no echo when making a recording.



Project 24

Sound Controlled Light

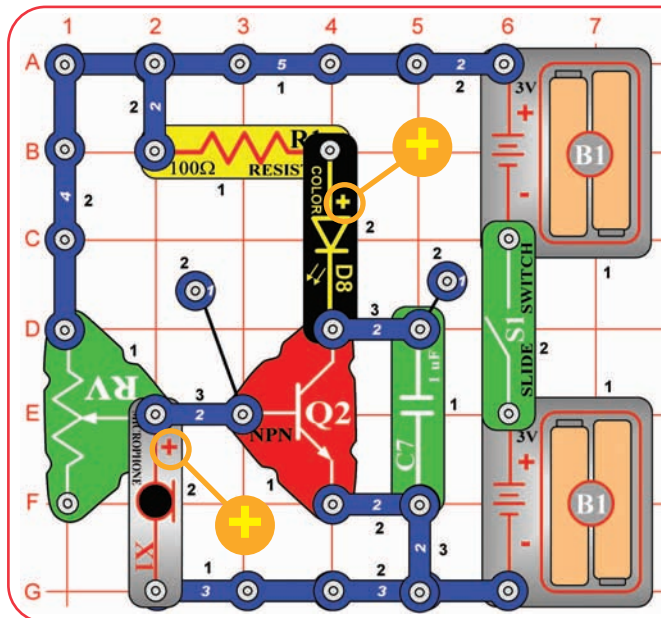

Build the circuit as shown. Turn on the switch (S1) and set the lever on the adjustable resistor (RV) so the color LED (D8) is just of. Talk loud into the microphone (X1) or clap loudly near it to activate the color LED. Try a long loud “ahhhhhhhh” directly into the microphone; this can make the color LED change patterns.

The color LED may not be very bright, so this circuit works best in a dimly lit room.

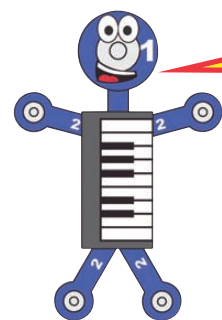

If the adjustable resistor's lever is set too low then the color LED will never turn on; if it is set too high then the color LED will never turn off.

Project 25 Low Pitch Keyboard

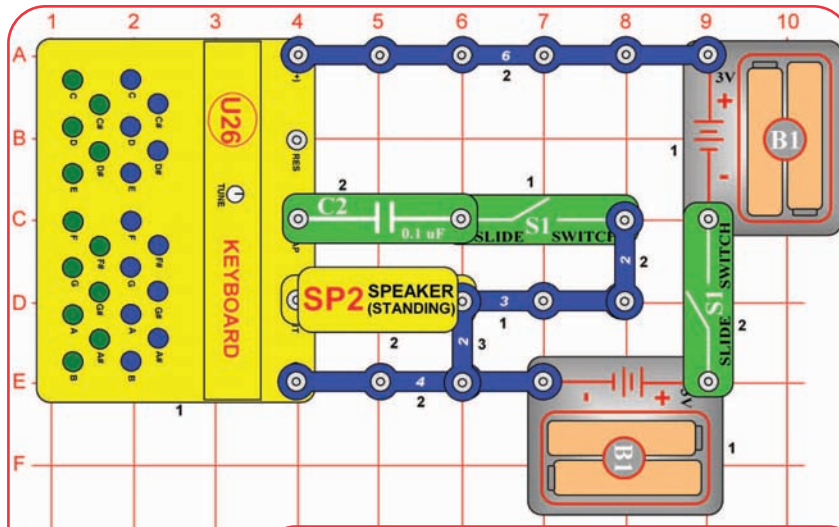

Adding the 0.1mF capacitor lowers the frequency (pitch) of the sound produced by the green keys, and makes them similar to the blue keys.

Build the circuit as shown. Turn off the left slide switch and turn on the right slide switch (S1), and press some of the green keys. Now turn on the left slide switch to add the 0.1mF capacitor (C2) to the circuit, and press some green keys again. The pitch (frequency) of the sound is lower now. The blue keys will not be affected.

Compare the sound for blue and green keys at the same place on the keyboard (such as **C** to **C**, **F#** to **F#**, or **B** to **B**). Turn the TUNE knob to align a pair of blue/green together, or to take them out of alignment. Experiment to see some interesting effects.

Project 26 Lower Pitch Keyboard

Use the preceding circuit, but replace the 0.1mF capacitor (C2) with the 1 mF capacitor (C7). The pitch of the green keys is much lower now. See how the blue and green keys sound when pressed together.

Project 27 Very Low Pitch Keyboard

Use the preceding circuit, but replace the 1mF capacitor (C7) with the 470 mF capacitor (C5, "+" on left). Press one of the green keys and hold it down; all you should hear is a click every few seconds.

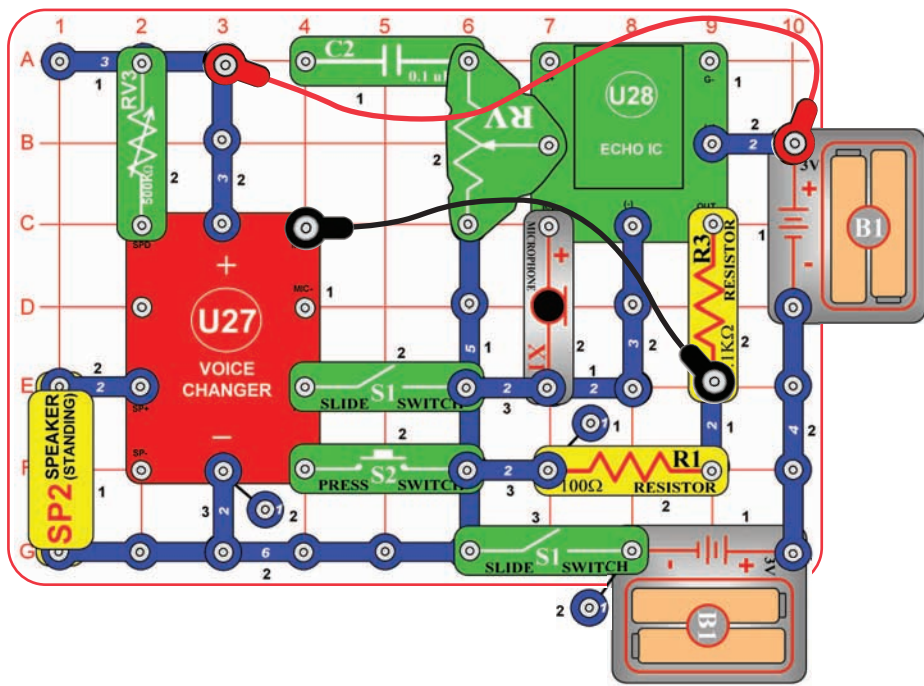

Project 28 Echo Speed Changer

Set the 500k adjustable resistor (RV3) to mid-range, turn OFF the left slide switch (S1), and then turn on the right slide switch. Set the echo level using adjustable resistor (RV). Now turn on the left slide switch, you hear a beep signaling that you are recording. Talk into the microphone (X1) until you hear a beep (signaling that recording time is over), then turn off the left slide switch to exit recording mode. Push the press switch (S2) to play back the recording, and turn the knob on RV3 to change the playback speed. You can play your recording faster or slower by changing the setting on RV3, and with more or less echo by changing the setting on RV.

Recording time is 6 seconds at normal speed, but this can be changed depending on the setting of R V3 when you are making the recording. C2 is only used to support RV, so is only connected on one side.

Project 29

Keyboard Echo

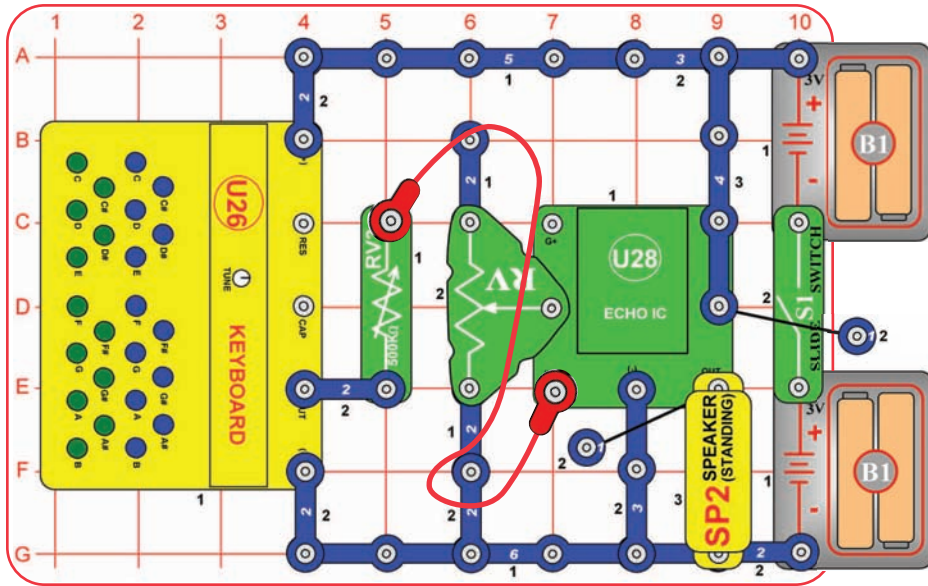

Build the circuit as shown, and turn on the slide switch (S1). Press keys on the keyboard (U26) and hear the sound with echo on the speaker (SP2). RV adjusts the amount of echo, and RV3 adjusts the volume. Try this at different RV settings, because the effects are very interesting with both high and low echo amounts.

Project 30 Lower Pitch Keyboard Echo

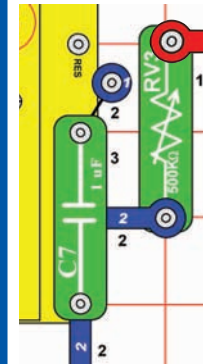

Use the preceding circuit, but add the 0.1mF capacitor (C2) or the 1 mF capacitor (C7) across the "CAP" and "(-)" snaps on the keyboard using a 1-snap wire. The pitch of the green keys is lower now.

Project 31 Optical Keyboard Echo

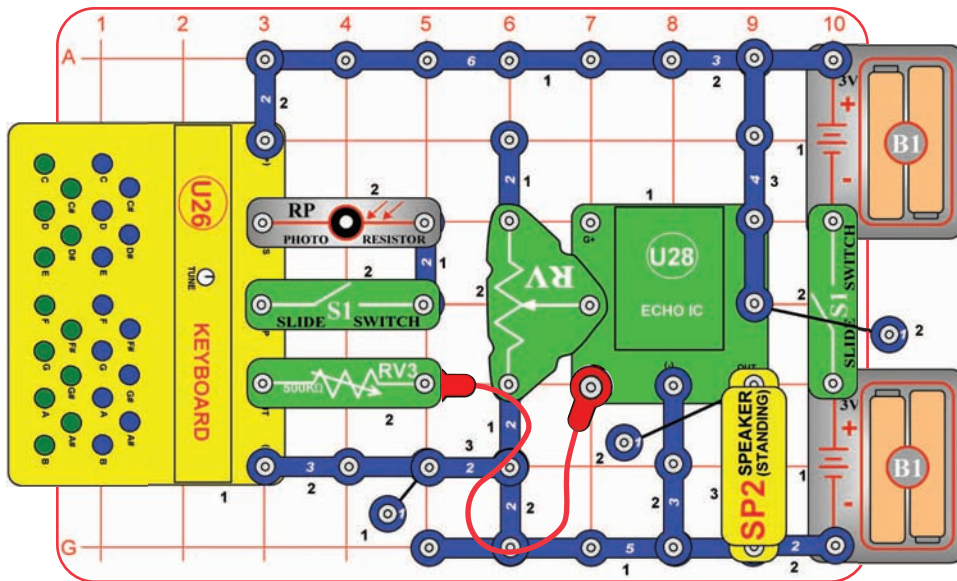

Build the circuit as shown, and turn on both slide switches (S1). Press keys on the keyboard (U26) or shine light into the photoresistor (RP) to hear sound with echo on the speaker (SP2). RV adjusts the amount of echo, and RV3 adjusts the volume. Wave your hand over the photoresistor to adjust the pitch of the "optical" sound. Try this at different RV settings, because the effects are very interesting with both high and low echo amounts. There may not be any sound if there is too much or too little light on the photoresistor.

Project 32 Low Pitch Optical Keyboard Echo

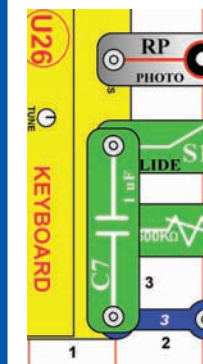

Use the preceding circuit, but add the 0.1mF capacitor (C2) or the 1 mF capacitor (C7) across the "CAP" and "(-)" snaps on the keyboard. The pitch of the green keys is lower now.



Project 33

Keyboard Echo with Stereo Effects

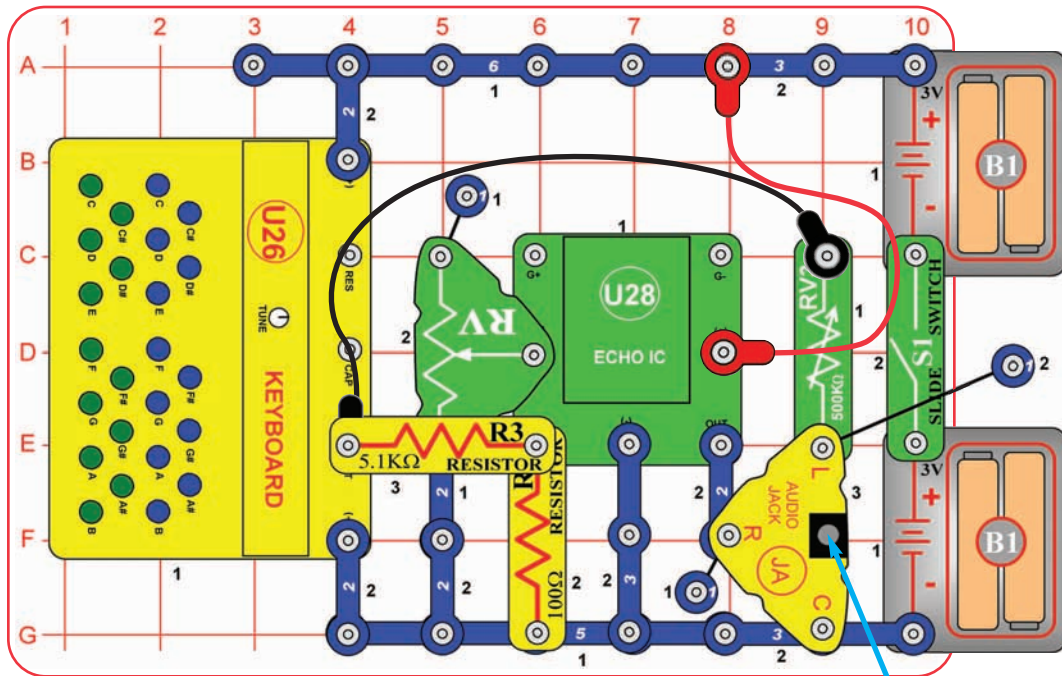

Headphones or Stereo Speaker (not included)

WARNING: Headphones performance varies, so use caution. Start with low volume, then carefully increase to a comfortable level. Permanent hearing loss may result from long-term exposure to sound at high volumes.



The 100Ω and 5.1kΩ resistors (R1 & R3) make the keyboard signal smaller, otherwise it would be distorted by the amplifier in the echo IC.

In this project you will listen to the keyboard sound both with and without echo, at the same time (in stereo). This project requires stereo headphones or a stereo speaker; neither is included with this set, but this set does include a stereo cable to help connect to your stereo speaker.

Build the circuit as shown; note that the 5.1kΩ resistor (R3) is a tight fit over the adjustable resistor (RV) but does fit. Connect your own headphones or stereo speaker to the audio jack (JA). Turn on the slide switch (S1).

Press keys on the keyboard (U26), and listen to the sound on your headphones or stereo speaker. One ear (or side of the speaker) hears the keyboard directly, set RV3 for most comfortable sound level (turn to the left for higher volume, most of RV3's range will be very low volume). The other ear (or side of the speaker) hears the sound with echo; adjust the amount of echo using the lever on the adjustable resistor (RV). Try this at different RV settings, because the effects are very interesting with both high and low echo amounts.

If the echo sound is not loud enough then add the 1 μF capacitor (C7) next the echo IC (U28) as shown here:

For best effects, try to set RV3 so that the sound level is about equal on both sides of the headphones/speaker.



Project 34

Optical Echo in Stereo

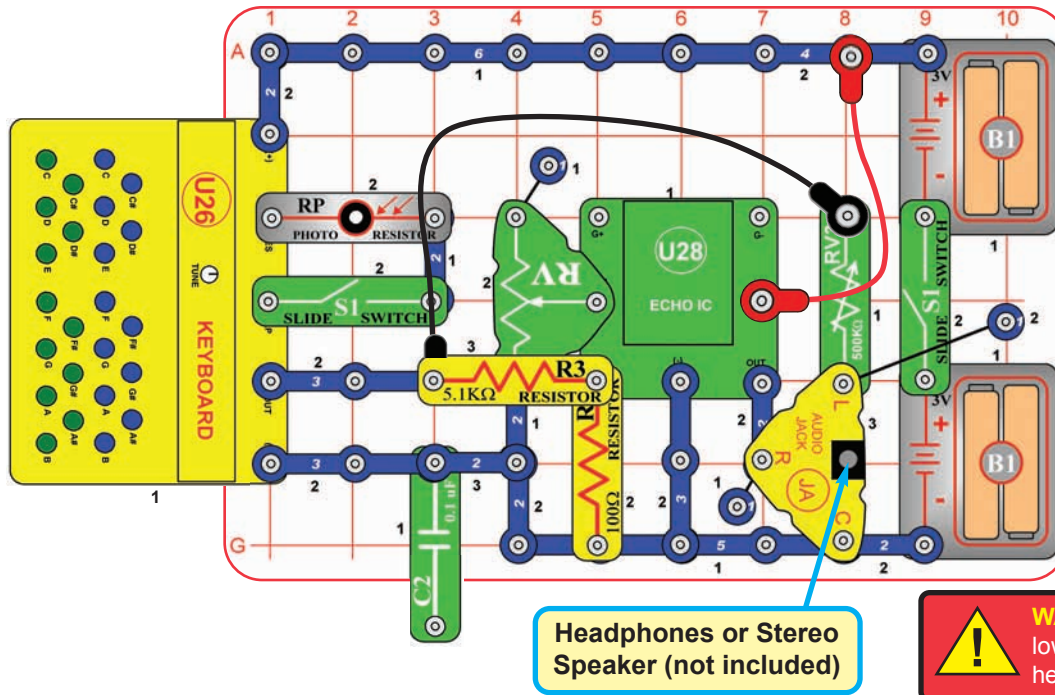

The project is similar to the preceding one, but adds optical control using the photoresistor (RP). Rebuild the preceding circuit to match this one. Follow the preceding circuit's instructions, except also turn on the slide switch next to the photoresistor, and then wave your hand over the photoresistor to change the sound.

The keyboard overhangs the base grid, so be sure the connections to it stay secure as you are pressing keys.

In the preceding circuit you could add the 1mF capacitor (C7) to make the echo sound louder, but do not have enough parts to add it to this circuit.



The 0.1mF capacitor (C2) is being used as a spacer (a 1-snap wire) to support other components.

WARNING: Headphones performance varies, so use caution. Start with low volume, then carefully increase to a comfortable level. Permanent hearing loss may result from long-term exposure to sound at high volumes.

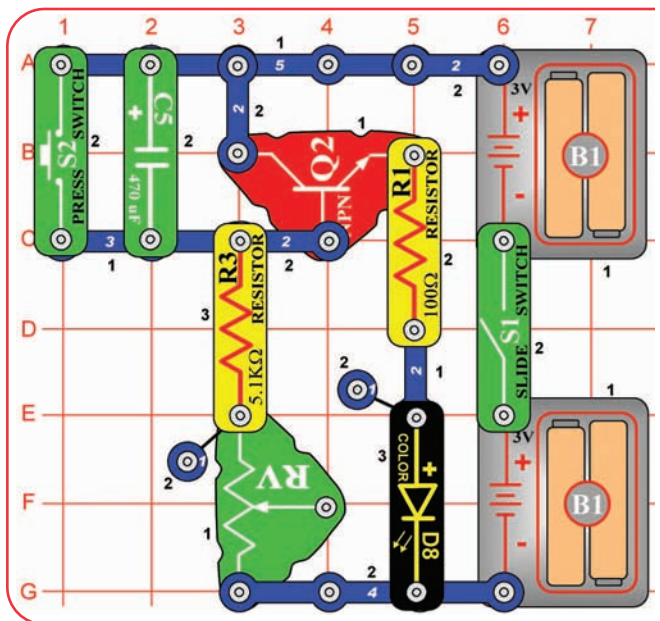

Project 35 Color Short Light

The light is on while the 470 mF capacitor (C5) is charging, and shuts off when the capacitor gets fully charged. Pressing S2 discharges the capacitor. The charge-up time is set by the capacitor's value and resistors R3 and RV.

Build the circuit, turn on the slide switch (S1), and push the press switch (S2). The color LED (D8) is on for a while and then shuts off. Turning S1 off and back on will not get the light back on. Push S2 to get the light back on. If desired, place the egg attachment on the color LED.

RV is used as a fixed resistor (50k Ω); so moving its control lever will have no effect.



Project 36 Keyboard with Optical Theremin

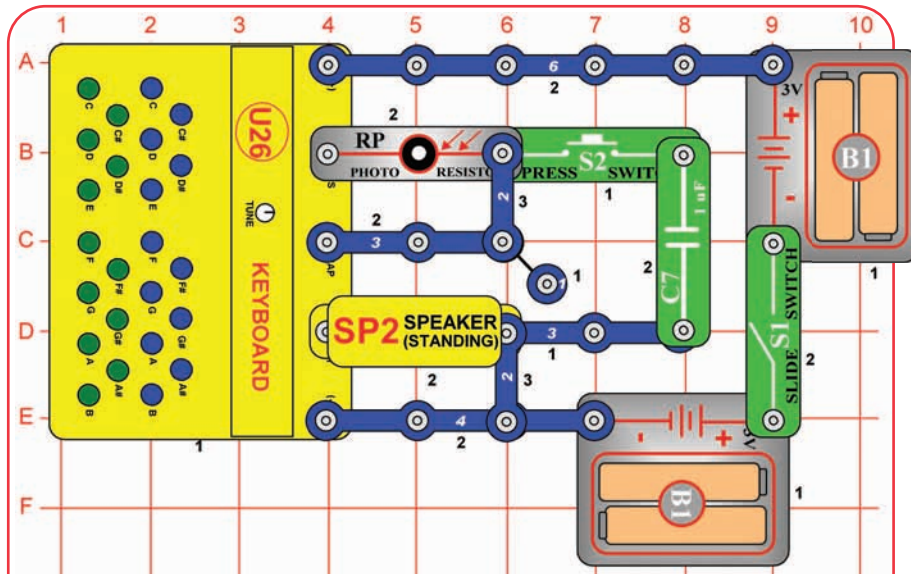

Build the circuit as shown and turn on the slide switch (S1). Press keys on the keyboard (U26), wave your hand over the photoresistor (RP) to adjust the amount of light shining on it, and listen to the sound. Push the press switch (S2) to change the pitch of the green keys. There may not be any sound if there is too much or too little light on the photoresistor.

Project 37 Keyboard with Optical Theremin (II)

Use the preceding circuit, but replace the 1mF capacitor (C7) with the 0.1mF capacitor (C2). The pitch of the green keys is higher when S2 is pressed.

Project 38 Adjustable Dual Range Keyboard

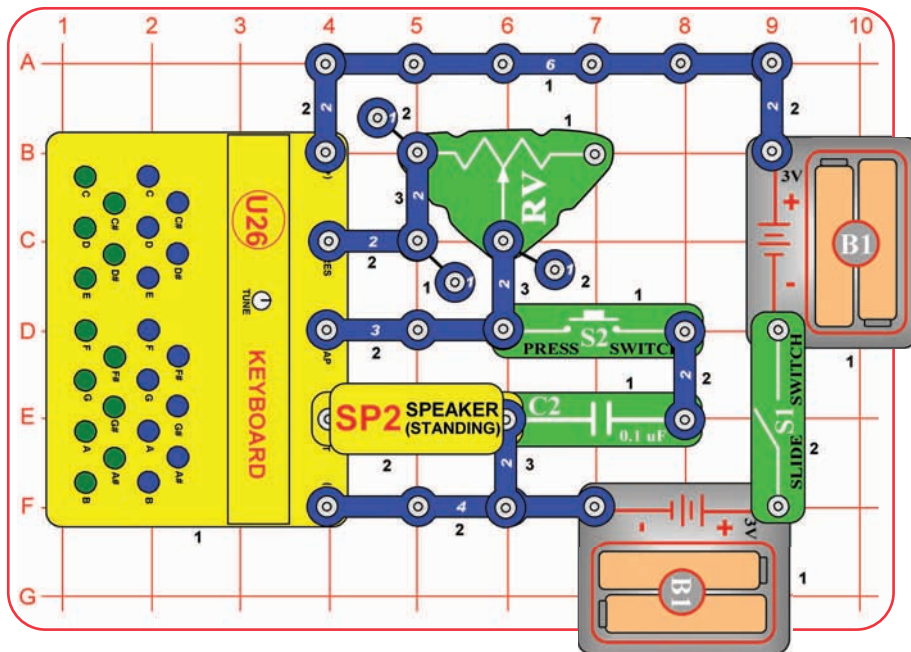

Build the circuit as shown and turn on the slide switch (S1). Press keys on the keyboard (U26) and move the lever on the adjustable resistor (RV) to change the sound. Push the press switch (S2) to change the pitch of the green keys. There may not be any sound at some settings on RV.

Project 39 Adjustable Dual Range Keyboard (II)

Use the preceding circuit, but replace the 0.1mF capacitor (C2) with the 1mF capacitor (C7). The pitch of the green keys is lower when S2 is pressed.

Project 40 Adjustable Dual Range Keyboard (III)

Use the preceding circuit, but replace the 1mF capacitor (C7) with the 470mF capacitor (C5, "+" on left). You will hear a click at regular intervals. The interval depends on the RV setting, it could be several per second or many seconds apart.



Project 41

Your Music with Echo

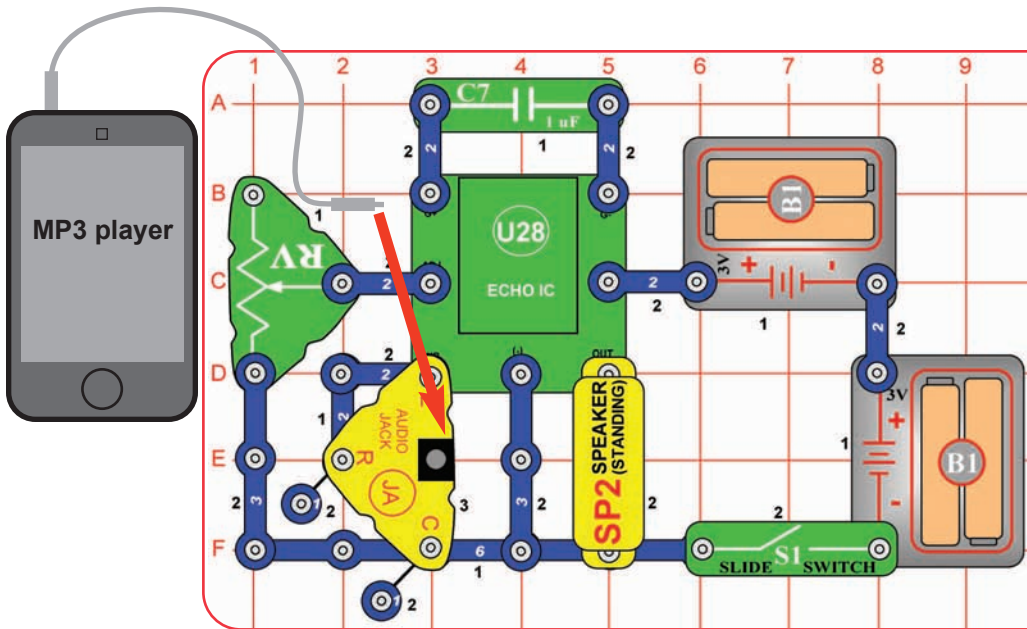

Build the circuit, and turn on the slide switch (S1). Connect a music device (not included, but this set does include a cable to connect it) to the audio jack (JA) as shown, and start music on it.

Set the volume control on your music device for a comfortable sound level, and adjust the amount of echo using the lever on the adjustable resistor (R V); move the lever up for more echo or down for less echo. Try this at different R V settings, because the effects are very interesting with both high and low echo amounts.

Try with different music, or with the touch-tones on your cell phone.



Project 42

Your Music with Echo and Light

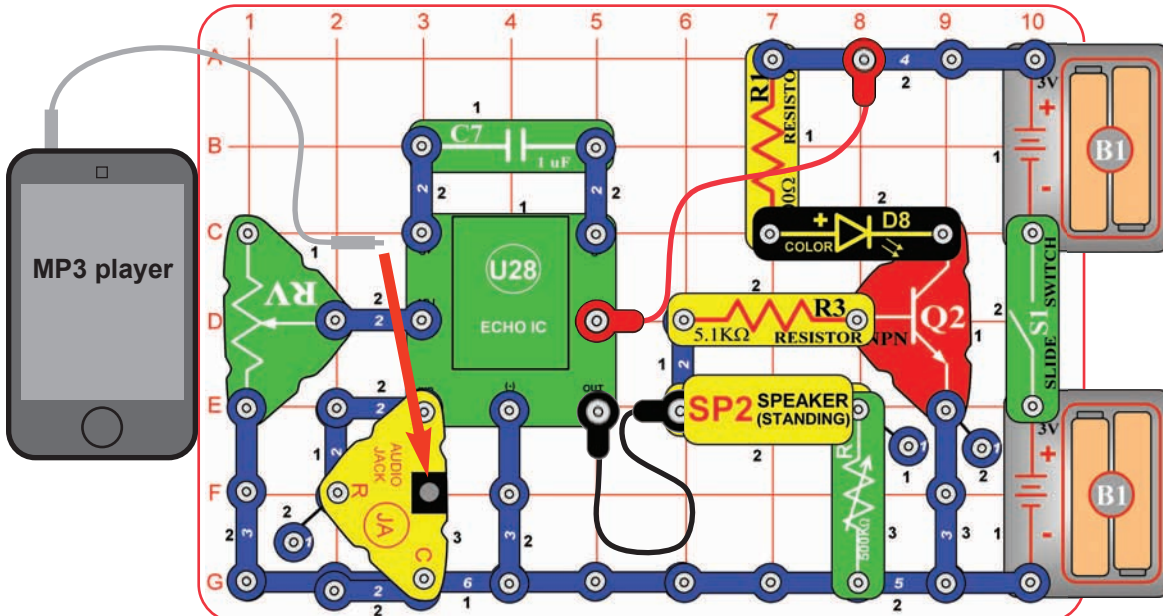

This circuit is similar to the preceding one, except it adds light and has lower sound volume. Build the circuit, and turn on the slide switch (S1). Connect a music device (not included) to the audio jack (JA) as shown, and start music on it. Set the knob on the 500kΩ adjustable resistor (RV3) all the way to the left (for loudest sound).

Set the volume control on your music device for a comfortable sound level, and adjust the amount of echo using the lever on the adjustable resistor (RV). Try this at different RV settings. The color LED (D8) will light when the sound is loud enough.

Try with different music, or with the touch-tones on your cell phone.



Project 43

Your Music Speed Changer

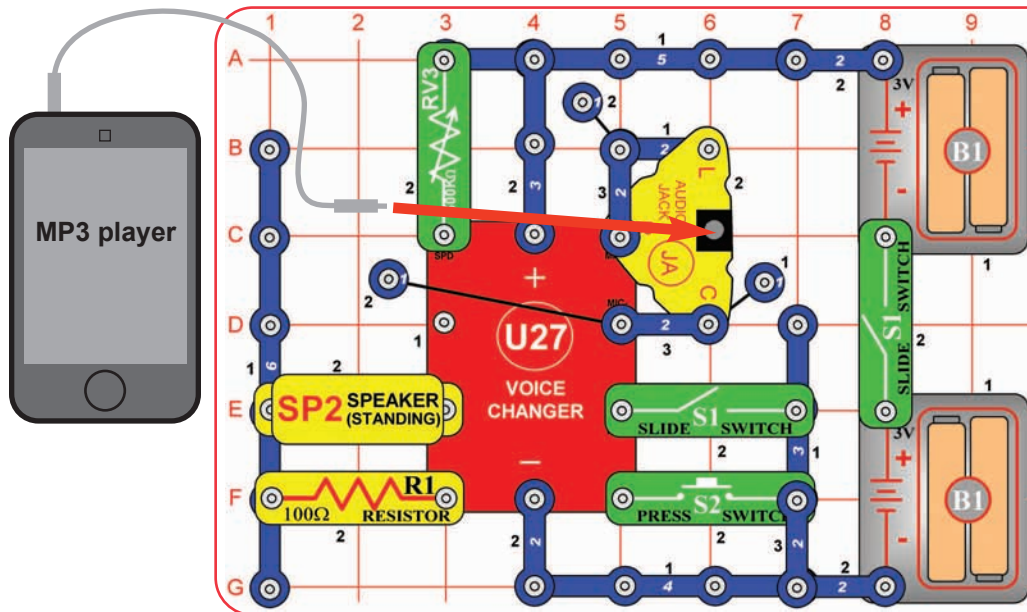

Build the circuit as shown. Set the 500k W adjustable resistor (RV3) to mid-range, turn OFF the left slide switch (S1), and then turn on the right slide switch. Connect a music device (not included) to the audio jack (JA) as shown, and start music on it.

Now turn on the left slide switch, you hear a beep signaling that recording has started. Wait until you hear a beep (signaling that recording time is over), then turn off the left slide switch to exit recording mode. Push the press switch (S2) to play back the recording, and turn the knob on R V3 to change the playback speed. You can play your recording faster or slower by changing the setting on RV3. Try with different music, or with the touch-tones on your cell phone.

To adjust the volume, adjust it on your music device before recording, or see the next project.

Recording time is 6 seconds at normal speed, but this can be changed depending on the setting of RV3 when you are making the recording.



Project 44 Your Music Speed Changer (II)

Use the preceding circuit, but replace the 100 W resistor (R1) with a 3-snap wire to make the sound louder, or with the 5.1k W resistor (R3) to make the sound quieter.



Project 45 Your Music Speed Changer (III)

Use the circuit from project 43, but replace the 100 W resistor (R1) with the color LED (D8, "+" to the left). Now when you press S2 to play the recording, the color LED will be flashing.

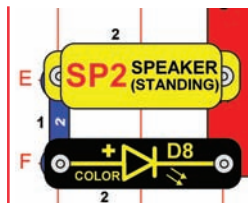

Project 46 Sound On Light

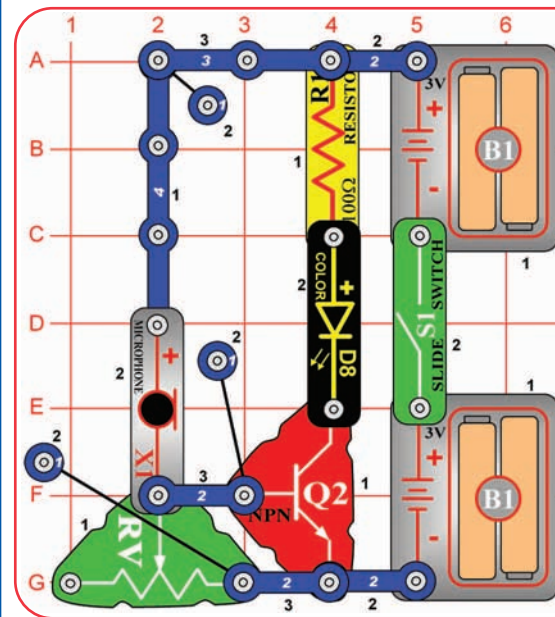

Build the circuit as shown and turn on the slide switch (S1). Set the lever on the adjustable resistor (RV) so the color LED (D8) just shuts off. Talk loudly into the microphone (X1), blow on it, or clap near it to make the LED flicker on.

Project 47

Super Optical Keyboard Echo

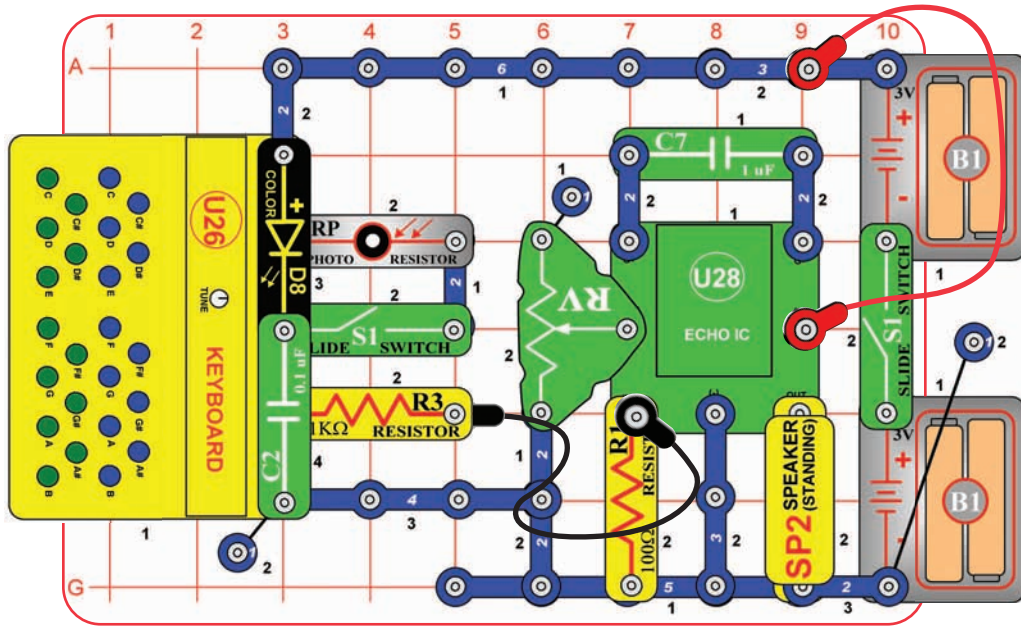

Build the circuit as shown. Turn off the left slide switch (S1), and turn on the right slide switch. Press some of the keyboard keys and listen to the echo. Move the lever on the adjustable resistor (RV) to change the amount of echo (up is maximum echo, down is no echo). Try this at different RV settings, because the effects are very interesting with both high and low echo amounts. The color LED (D8) will light when any green key is pressed, but will not be very bright.

Now turn on the left slide switch to add the photoresistor (RP) to the circuit. Wave your hand over the photoresistor to change the sound. Try it with different levels of light shining on the photoresistor, and at different RV settings.

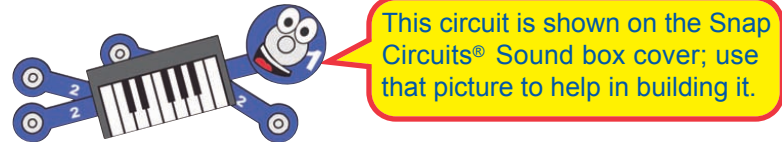

Project 48 Softer Optical Keyboard Echo

Use the preceding circuit, but remove the 1mF capacitor (C7) from the circuit, or swap it with the 0.1 mF capacitor (C2), or replace it with the 470mF capacitor (C5). The sound volume is different now.

Project 49 Reflection Detector

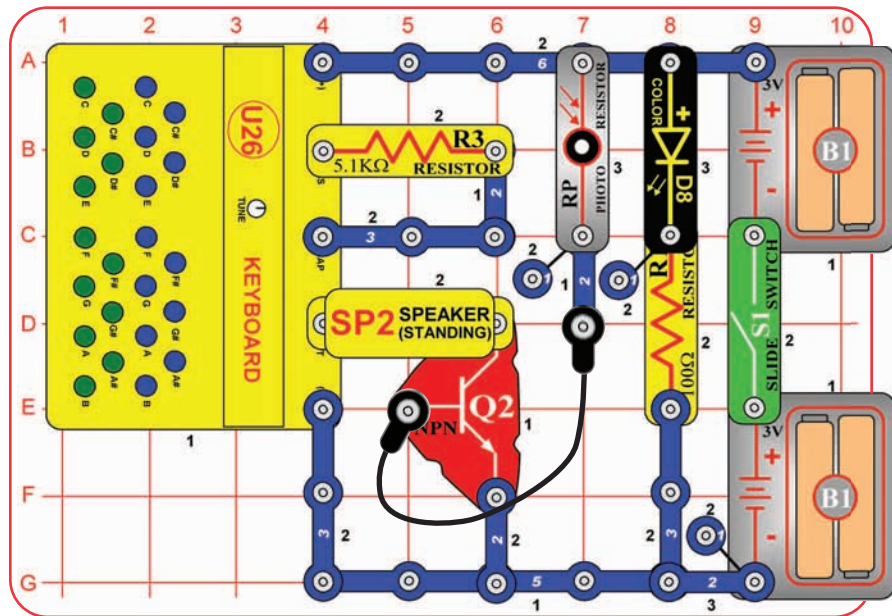

Build the circuit and turn the slide switch (S1). Take it into a dimly lit room, so that the color LED (D8) is flashing but there is no sound.

Now hold a mirror directly over the color LED and photoresistor (RP). When the mirror reflects the LED's light into the photoresistor, a tone will be produced, signaling that a reflection was detected. The tone will change as the LED flashes.



Project 50

Super Optical Keyboard Echo for Headphones

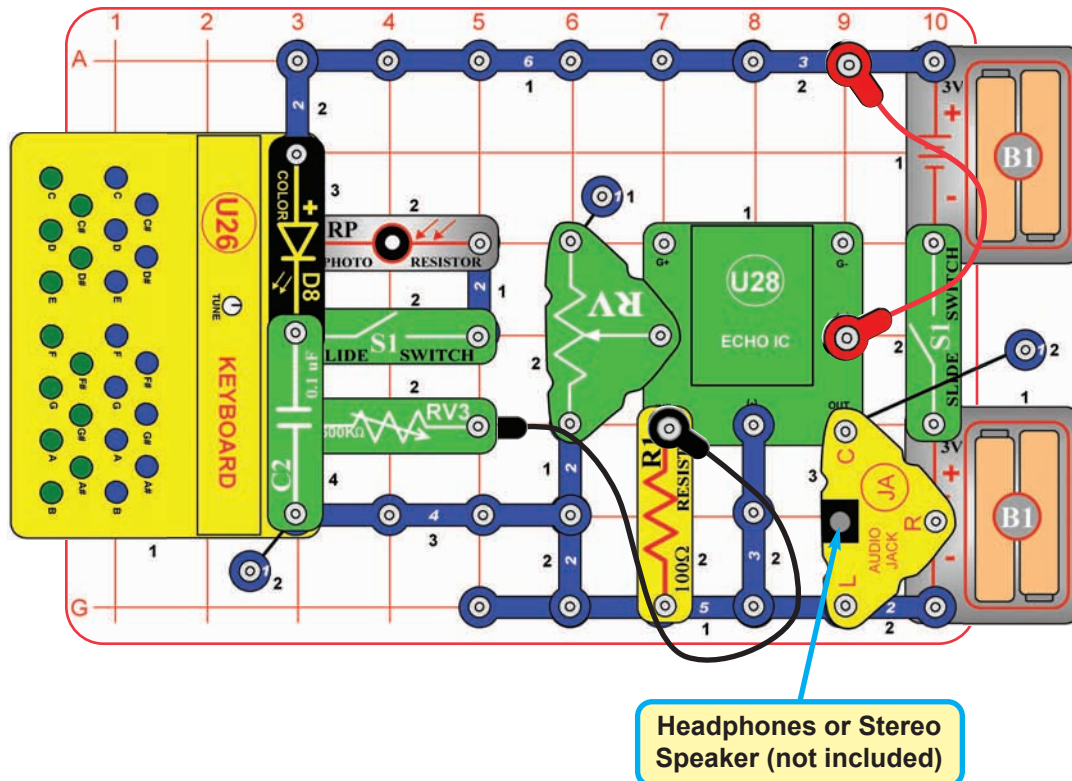

Build the circuit as shown. This project requires stereo headphones or a stereo speaker (neither is included). Turn off the left slide switch (S1), and turn on the right slide switch. Press some of the keyboard keys and listen to the echo. Set the 500k W adjustable resistor (RV3) for most comfortable sound level (turn to the left for higher volume, most of RV3's range will be very low volume). Move the lever on the adjustable resistor (RV) to change the amount of echo (up is maximum echo, down is no echo). Try this at different RV settings, because the effects are very interesting with both high and low echo amounts. The color LED (D8) will light when any green key is pressed, but will not be very bright.

Now turn on the left slide switch to add the photoresistor (RP) to the circuit. Wave your hand over the photoresistor to change the sound. Try it with different levels of light shining on the photoresistor, and at different RV settings.

Note that the "R" snap on the audio jack is not snapped or connected, so there will not be any sound from the "R" side of your headphones/speaker.

You can replace the 0.1 mF capacitor (C2) with the 1 mF capacitor (C7) to lower the pitch of the green keys.

WARNING: Headphones performance varies, so use caution. Start with low volume, then carefully increase to a comfortable level. Permanent hearing loss may result from long-term exposure to sound at high volumes.



Project 51

Sound is Air Pressure

Sound is a variation in air pressure created by a mechanical vibration. For a demonstration of this, take a stereo speaker in your home (the larger the better), lay it on the floor, and start some music.

1. Place your hand on your stereo speaker and turn up the volume. Do you feel the speaker vibrate?

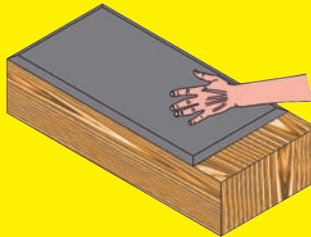

2. Now place a piece of paper on the speaker; if the sound is loud enough, you will see the paper vibrate.



3. Take a balloon (not included) and hold it on the speaker. You should feel it vibrating with the sound.



4. Get your parents' permission for this part, because it could get messy. Place the sound energy demonstration container (which should have been assembled as per instructions on page 4) on the center of the speaker. Pour some salt, glitter, small foam or candy balls (0.1 inch diameter or less) or similar into the container, but not enough to cover the bottom. Slowly increase the music volume. When the music is at certain frequencies, the salt/glitter/balls will bounce around in the container.

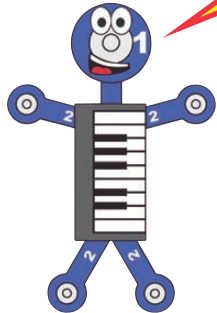

Project 52

Sound is Air Pressure - Keyboard

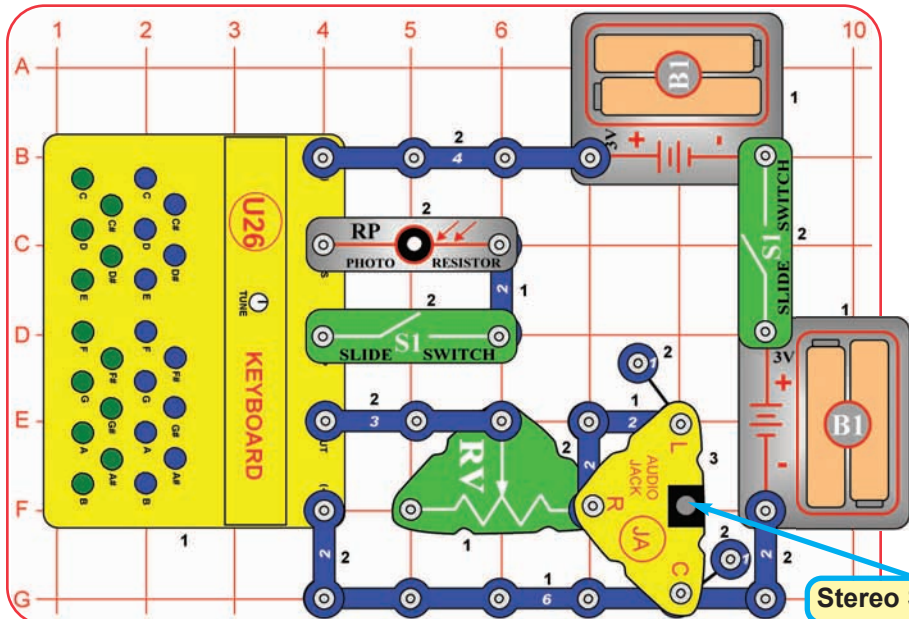

Your Snap Circuits® speaker (SP2) is not powerful enough to use for this, unless using the sound energy demonstration container as done in project 13.



Stereo Speaker (not included)

If you have a stereo speaker (not included), then you can also do the preceding demonstration using the sounds from your keyboard (U26). Build the circuit as shown, and connect your stereo speaker to it. Start with the left slide switch (S1) turned off and the right switch turned on. Press keys to find the one that gives the best effects with the 3 experiments in the preceding project, then turn the tune knob on the keyboard to see if you can make the effects even better.

Now turn on the left slide switch to add the photoresistor (RP) to the circuit. Move your hand over the photoresistor to adjust how much light shines into it, to change the sound to give the best effects for the 3 experiments in the preceding project.



Project 53

Brightness Adjuster

Build the circuit and turn on the slide switch (S1). Move the lever on the adjustable resistor (RV) to vary the brightness of the light from the color LED (D8). If desired, you may place the egg LED attachment on the LED.

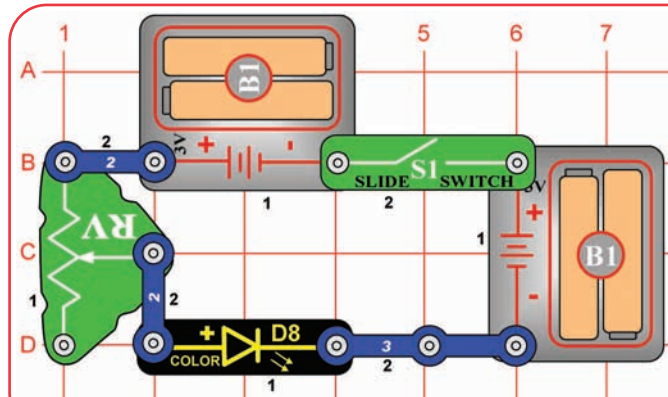

Resistors are used to control or limit the flow of electricity in a circuit. Higher resistor values reduce the flow of electricity in a circuit. In this circuit, the adjustable resistor is used to adjust the LED brightness, to limit the current so the batteries last longer, and to protect the LED from being damaged by the batteries. What is Resistance? Take your hands and rub them together very fast. Your hands should feel warm. The friction between your hands converts your effort into heat. Resistance is the electrical friction between an electric current and the material it is flowing through. The adjustable resistor can be set for as low as 200 W, or as high as 50,000W (50kW).



Project 54 Brightness Limiters



Project 55 Big Brightness Adjuster



Use the preceding circuit, but replace the 3-snap with one of the yellow resistors in this set (R1 or R3). Observe how each changes the LED brightness at different settings for the adjustable resistor.

The R1 resistor (100 W) will have little effect, because the adjustable resistor (RV) will always dominate it. Resistor R3 (5.1k W) will dominate when R V is set for low values, but have little effect when RV is set at high values.

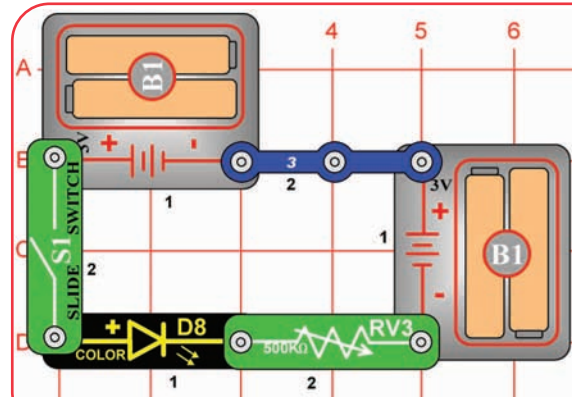
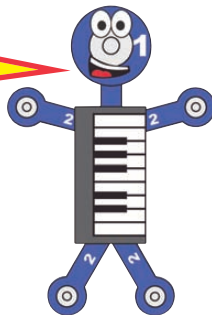

Vary the brightness of the color LED (D8) using the 500k W adjustable resistor (RV3).

The 500kW adjustable resistor (RV3) can be set for as low as 200W, or as high as 500,000W (500kW), so the color LED will only light on a small portion of RV3's range.





Project 56

Photo Brightness Adjuster

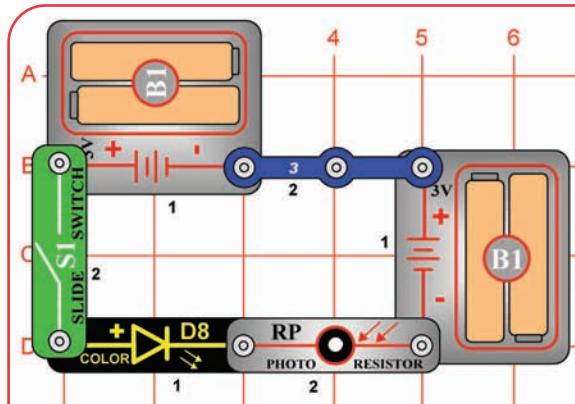

Some materials, such as Cadmium Sulfide, change their resistance when light shines on them. Electronic parts made with these light-sensitive materials are called photoresistors. Their resistance decreases as the light becomes brighter.

The resistance of your Snap Circuits® photoresistor changes from nearly infinite in total darkness to about 1kΩ when bright light shines directly on it. Note that a black plastic case partially shields the Cadmium Sulfide part.

Photoresistors are used in applications such as streetlamps, which come on as it gets dark due to night or a severe storm.

Vary the brightness of the color LED (D8) by varying the amount of light shining on the photoresistor (RP).



Project 57 Amplified Photo Brightness Adjuster

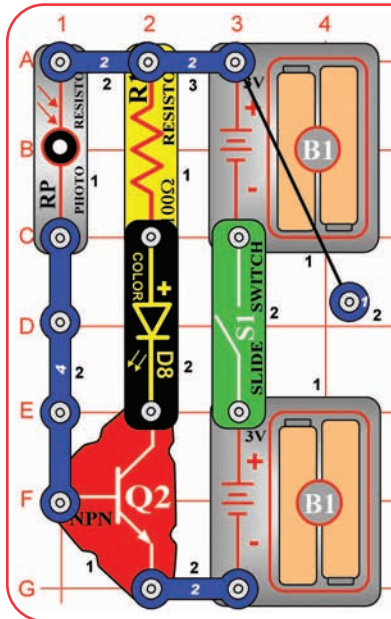

Vary the brightness of the color LED (D8) by varying the amount of light shining on the photoresistor (RP). Notice that you have to cover the photoresistor to make the color LED dim.

In the preceding circuit the photoresistor directly controlled the current through the color LED. In this circuit the current through the photoresistor is amplified by the NPN transistor (Q2), so the light on the photoresistor must get very dark before the color LED brightness is reduced.



Project 58 Amplified Big Brightness Adjuster

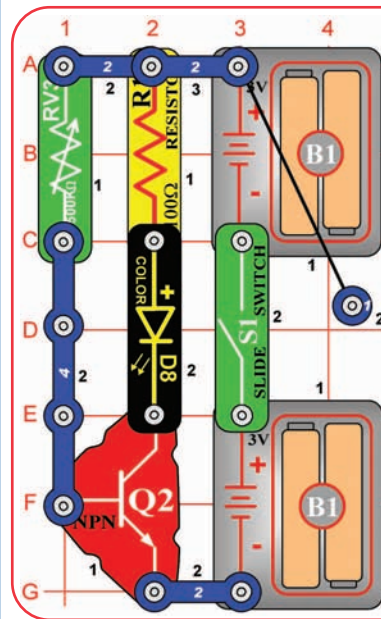

Vary the brightness of the color LED (D8) using the 500kΩ adjustable resistor (RV3). The brightness won't change a lot; you may need to view it in a dark room to notice the difference. Placing the egg attachment on the color LED may help to notice the brightness difference.

Compare this circuit to project 55 (Big Brightness Adjuster). In project 55 the color LED was dark for most of RV3's range. In this circuit the NPN transistor (Q2) amplifies the current through RV3, so the color LED is bright for most of RV3's range.



Project 59

Cup & String Communication

Sound, radio signals, and light all travel through air like waves travel through water. To help you understand how they are like waves, you can make a cup & string telephone. This common trick requires some household materials (not included with this kit): two large plastic or paper cups, some non-stretchable thread or kite string, and a sharp pencil. Adult supervision is recommended.

Take the cups and punch a tiny hole in the center of the bottom of each with a sharp pencil (or something similar). Take a piece of string (use between 25 and 100 feet) and thread each end through each hole. Either knot or tape the string so it cannot go back through the hole when the string is stretched. Now with two people, have each one take one of the cups and spread apart until the string is tight. The key is to make the string tight, so it's best to keep the string in a straight line. Now if one of you talks into one of the cups while the other listens, the second person should be able to hear what the first person says.

How it works: When you talk into the cup, the cup bottom vibrates back and forth from your sound waves. The vibrations travel through the string by pulling the string back and forth, and then make the bottom of the second cup vibrate just like the first cup did, producing sound waves that the listener can hear. If the string is tight, the received sound waves will be just like the ones sent, and the listener hears what the talker said.

Telephones work the same way, except that electric current replaces the string. In radio, the changing current from a microphone is used to encode electromagnetic waves sent through the air, then decoded in a listening receiver.

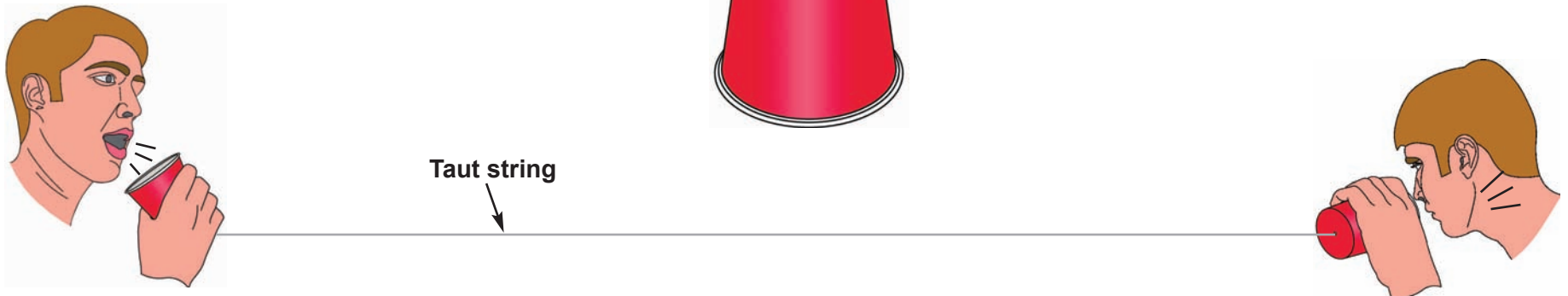
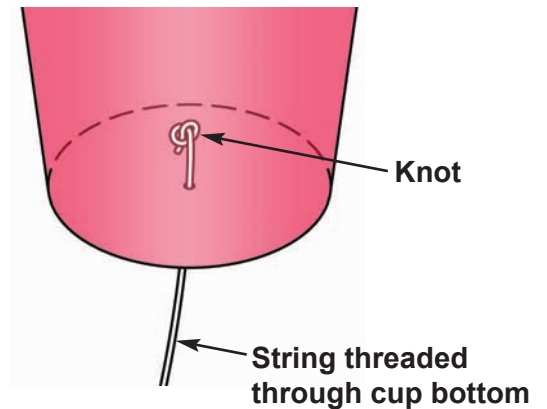
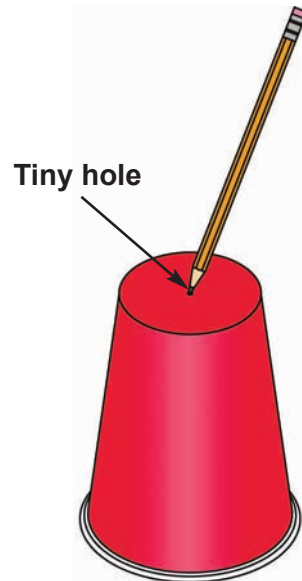
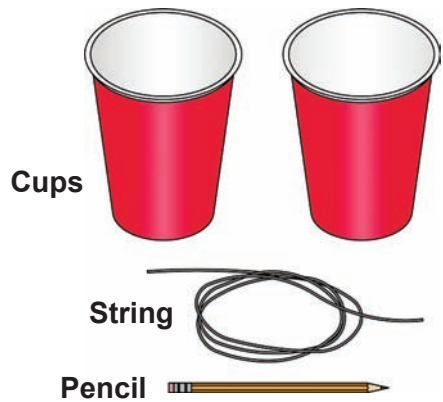
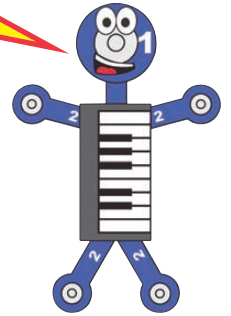

Project 60

Audio Amplifier

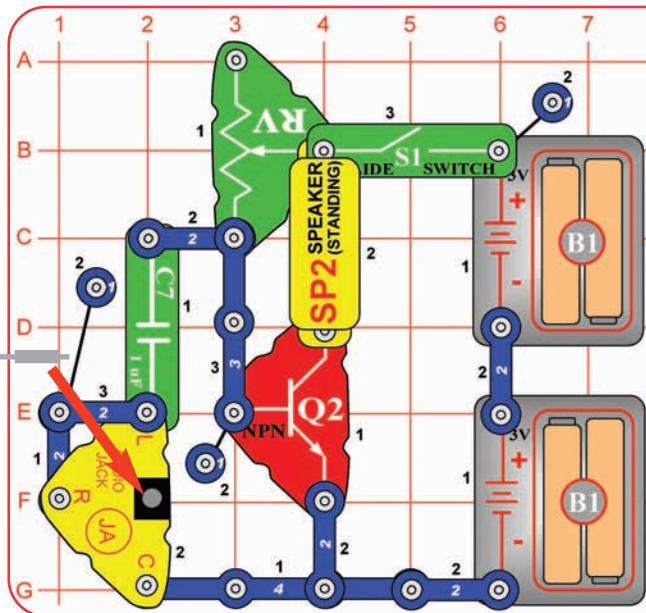

Build the circuit, and turn on the slide switch (S1). Connect a music device (not included) to the audio jack (JA) as shown, and start music on it. Set the volume using the lever on the adjustable resistor (RV). This is a simple amplifier, so the sound may not be very loud.

Project 61

Low Power Audio Amplifier

Use the preceding circuit, but replace one of the battery holders (B1) with a 3-snap wire. The circuit works the same but is not as loud now.

Project 62

Audio Amplifier with L/R Control

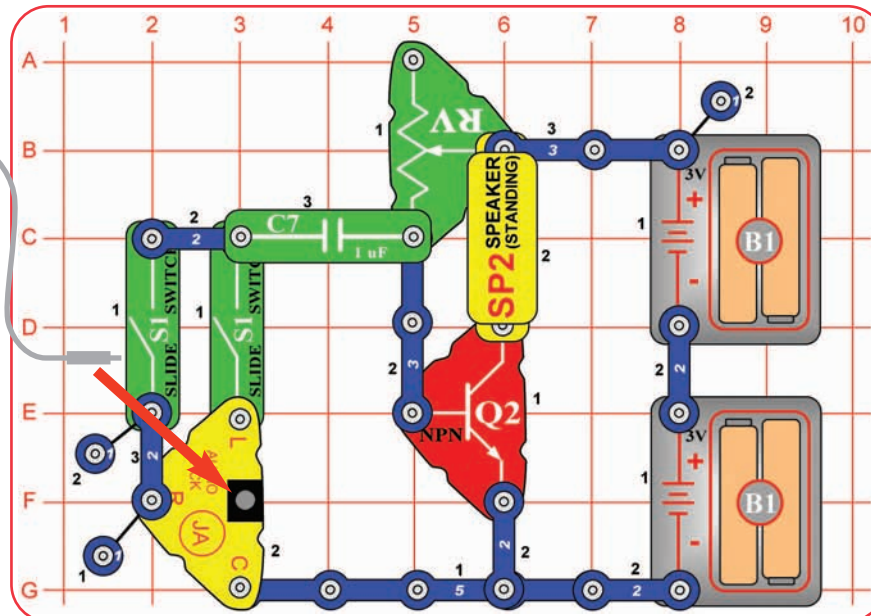

Build the circuit, and connect the 2-snap wire between the B1 battery holders last. Connect a music device (not included) to the audio jack (JA) as shown, and start music on it. Turn on both of the slide switches (S1), and set the volume using the lever on the adjustable resistor (RV). This is a simple amplifier, so the sound may not be very loud.

Turn off either of the slide switches to shut off the left or right outputs of your music device. If the left and right outputs of your music signal are the same, then turning off one switch will reduce the volume a little.

When finished, remove the 2-snap wire between the battery holders to turn off the circuit.



This circuit does not have an on/off switch, because the slide switches are being used to control the music device outputs.



Project 63

Your Music without Echo

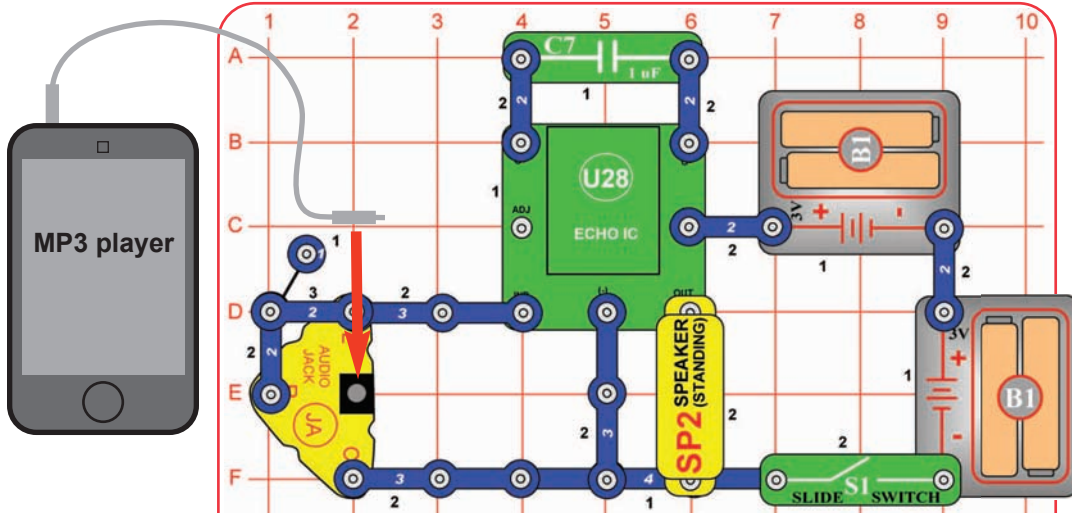

Build the circuit, and turn on the slide switch (S1). Connect a music device (not included, but this set does include a cable to connect it) to the audio jack (JA) as shown, and start music on it.

Set the volume control on your music device for a comfortable sound level.

Here we are using the amplifier inside the echo IC (U28), without adding any echo effects to the music.



Project 64

Low Power Your Music without Echo

Use the preceding circuit, but remove the 1 mF capacitor (C7) from the circuit, or replace it with the 0.1 mF capacitor (C2). The volume is not as loud now.



Project 65

Adjustable Music without Echo

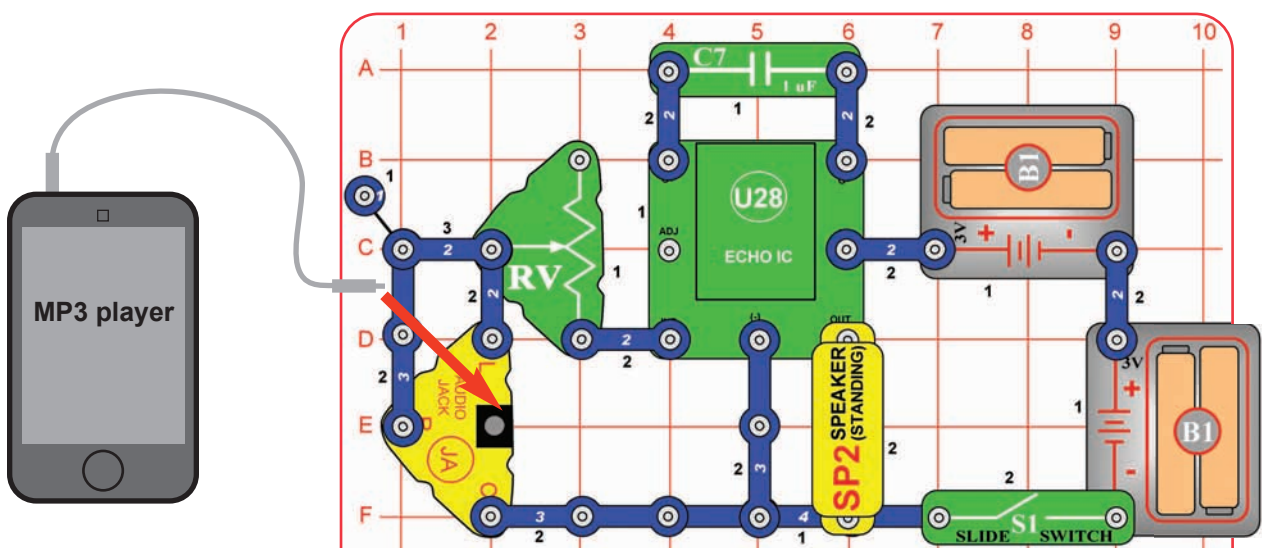

Modify the project 63 circuit to include a volume control, the adjustable resistor (RV). It works the same way, but adjust the volume using the lever on RV.



Project 66

L/R Music Amplifier

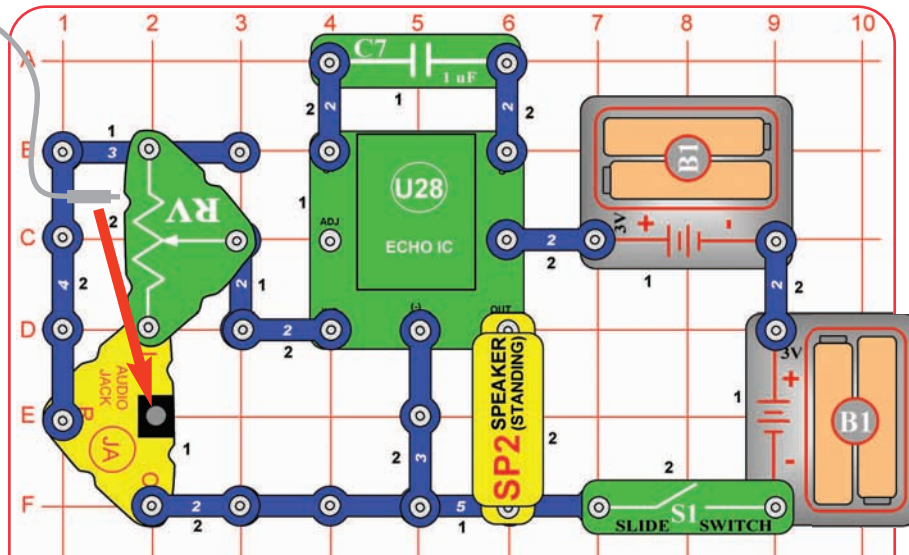

Build the circuit, and turn on the slide switch (S1). Connect a music device (not included) to the audio jack (JA) as shown, and start music on it. Use the lever on the adjustable resistor (RV) to adjust the volume for the left and right outputs of your music device; both won't be loud at the same time.

The left and right outputs of your music device are intended to control separate speakers, but are combined here because you only have one Snap Circuits® speaker.

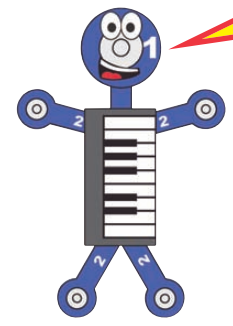

Project 67

Another Transistor Amplifier

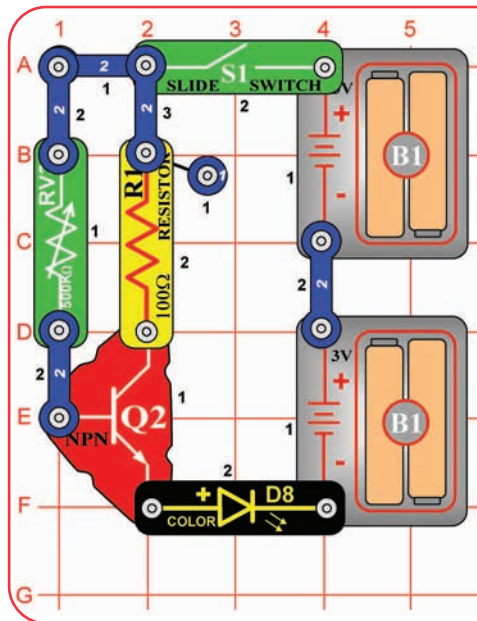

Vary the brightness of the color LED (D8) using the 500k W adjustable resistor (RV3).

This circuit is similar to project 58 (Amplified Big Brightness Adjuster), but the color LED will not be quite as bright. In this circuit both the controlling current (through R V3) and controlled current (through R1) also flow through the color LED, reducing the amplification.

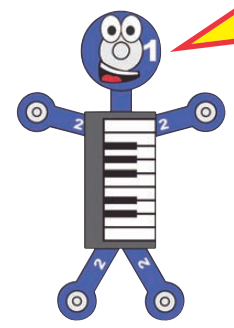



Project 68

Microphone Resistance - LED

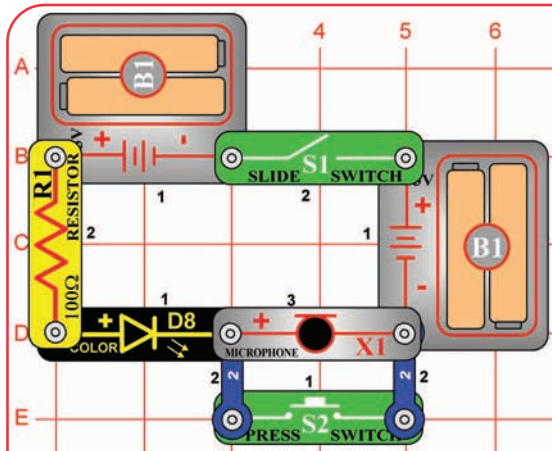

The microphone changes resistance when exposed to changes in air pressure, such as from sound waves or blowing on it. Talking into the microphone or blowing on it will change the LED brightness, but probably not enough for you to notice the difference.



Build the circuit, and turn on the slide switch (S1). The color LED (D8) is dimly lit, because the resistance of the microphone (X1) keeps the current low.

Push the press switch (S2) to bypass the microphone, and the LED gets bright.

You can also try replacing the microphone with the 5.1k Ω resistor (R3), to see how their resistances compare.



Project 69

Microphone Resistance - Audio

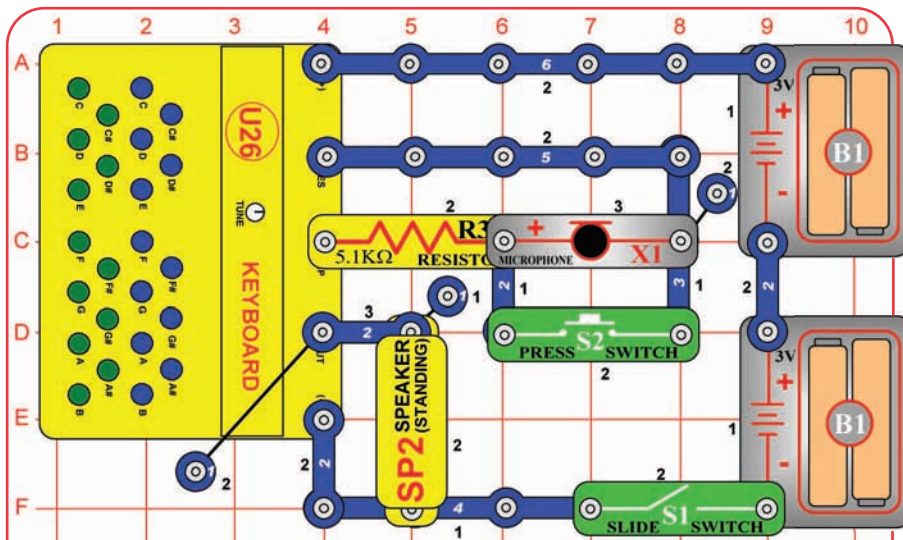

Build the circuit, and turn on the slide switch (S1). The resistance of the 5.1k Ω resistor (R3) and microphone (X1) determine the pitch (frequency) of the tone.

Push the press switch (S2) to bypass the microphone, and the tone changes.

Project 70

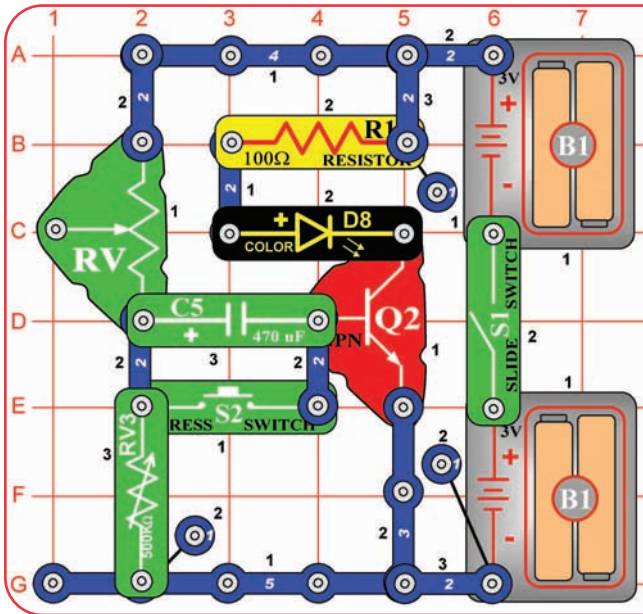

Time Light

Build the circuit, and turn on the slide switch (S1). Push the press switch (S2) and set the 500k W adjustable resistor (RV3) so the color LED (D8) just comes on, then release the press switch. The color LED will be bright for a while and slowly get dim and go out. Push the press switch again to reset the color LED's timer.

You can change RV3's setting to keep the color LED on much longer. The adjustable resistor (RV) is used here as a fixed resistor (of 50kΩ), so moving its lever will have no effect.

Project 71 Time Light (II)

Use the preceding circuit, but replace the adjustable resistor (RV) with the 5.1kΩ resistor (R3). The circuit works the same way, but the color LED gets dim faster.



The 470 mF capacitor (C5) can store electricity. This timer circuit works by slowly charging up C5; the color LED goes out when C5 gets full. If you replace C5 with C2 or C7, the LED will go out almost immediately because these values can't store nearly as much electricity.

Project 72

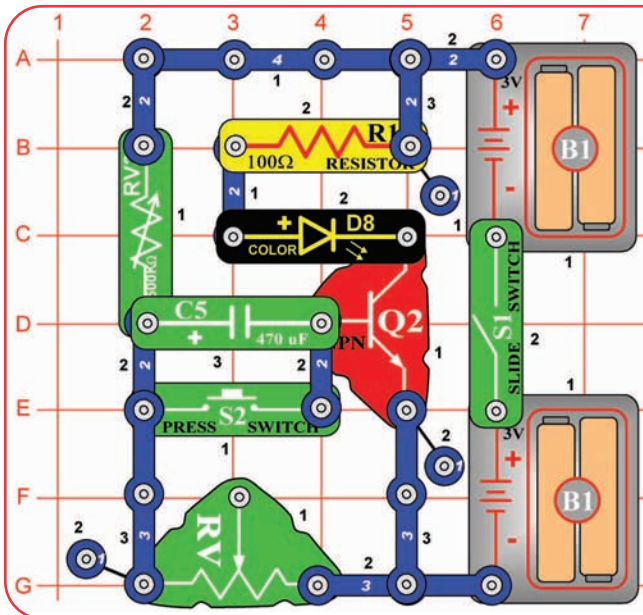

Easier Adjust Time Light

Build the circuit, and turn on the slide switch (S1) Push and release the press switch (S2). Set the 500k W adjustable resistor (RV3) so the color LED (D8) is on and bright, then wait for it to get dim and go out. Push the press switch again to reset the color LED's timer. The brighter the color LED starts, the faster it gets dim.

The adjustable resistor (RV) is used here as a fixed resistor (of 50kΩ), so moving its lever will have no effect.

Project 73 Small Adjust Time Light

Use the preceding circuit, but replace the adjustable resistor (RV) with the 5.1kΩ resistor (R3). The circuit works the same way, but the color LED can only light over a small part of RV3's range, and it gets dim faster.

Project 74 Day Light

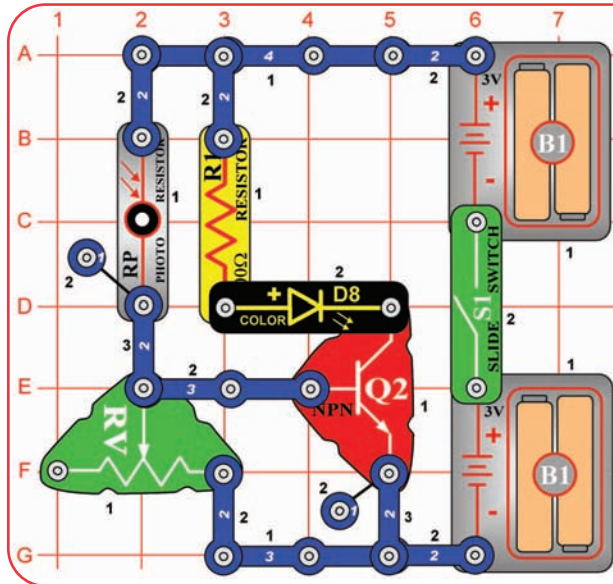

Build the circuit, and turn on the slide switch (S1). Set the lever on the adjustable resistor (RV) so the color LED (D8) just gets bright. Now when you block the light to the photoresistor (RP), the color LED will turn off. If the color LED cannot be turned on or off at any RV setting, then change your room lighting.

Project 75 Lower Day Light

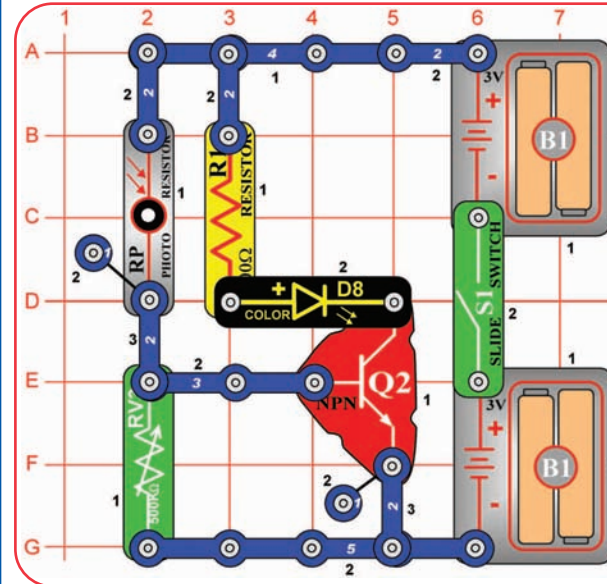

This circuit is like the preceding one, but can be used in darker rooms. Build the circuit, and turn on the slide switch (S1). Set the lever on the adjustable resistor (RV) so the color LED (D8) just gets bright. Now when you block the light to the photoresistor (RP), the color LED will turn off.

Project 76 Dark Light

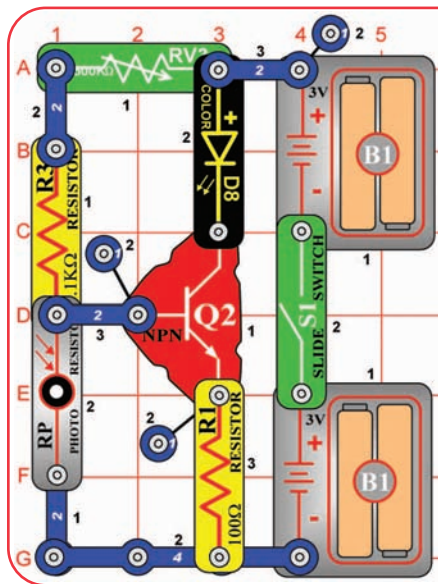

Build the circuit, and turn on the slide switch (S1). Set the knob on the 500k Ω adjustable resistor (RV3) all the way to the right. If the room light is bright then the color LED (D8) should be off. Cover the photoresistor (RP) or take the circuit into a dark room, and the color LED should turn on.

Project 77 Blow Noise

Build the circuit, and turn on the slide switch (S1). Blow into the microphone (X1), and hear it on the speaker (SP2).

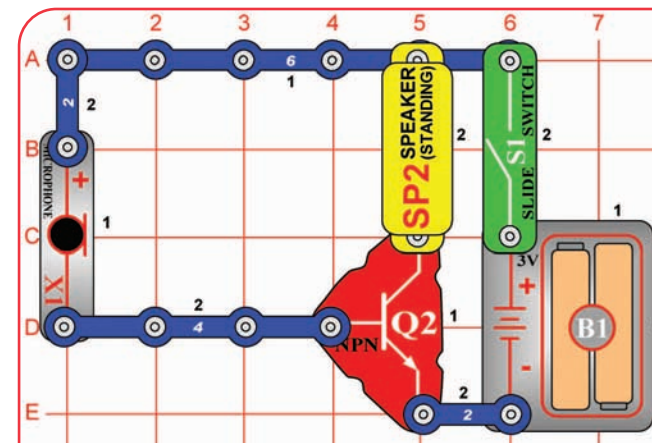



Project 78

Listen to the Light Change

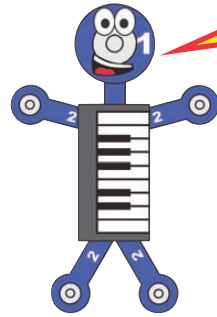
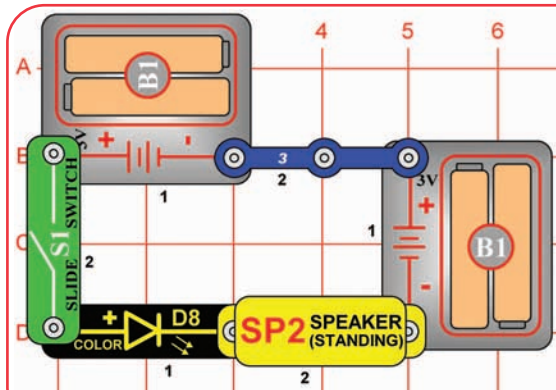

The color LED actually contains separate red, green, and blue lights, with a microcircuit controlling them. Each time the LED changes colors, the voltage across it changes. Each time the voltage changes, you hear a "click" from the speaker.

Turn on the slide switch (S1). The color LED (D8) changes colors in a repeating pattern, and you hear a clicking sound from the speaker (SP2).



Project 79 Adjustable Listen to the Light Change

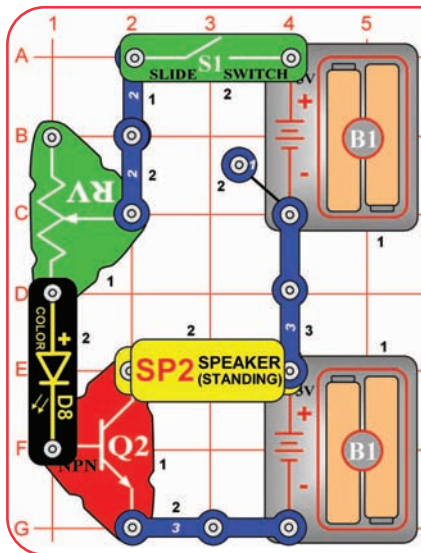

Turn on the slide switch (S1). Set the lever on the adjustable resistor (RV) for different brightness levels on the color LED (D8). You also hear a clicking sound from the speaker (SP2).

The transistor (Q2) amplifies the LED current, to make the speaker (SP2) sound louder.



Project 80 Bright or Loud?

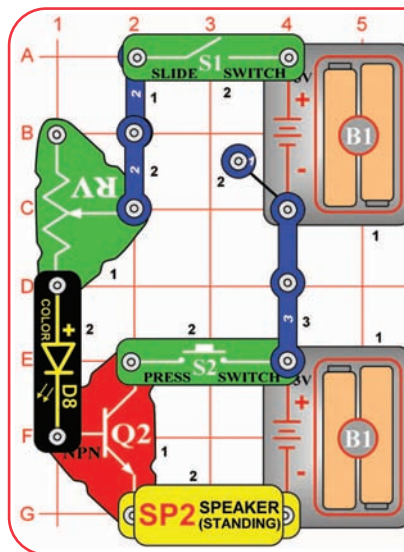

Turn on the slide switch (S1). Set the lever on the adjustable resistor (RV) for different brightness levels on the color LED (D8). The color LED is bright on a more limited range of RV settings than in the preceding project, and the speaker (SP2) is not nearly as loud.

Now push the press switch (S2); the LED is dimmer but the sound is louder.

When S2 is off the transistor (Q2) has little effect, and the circuit is similar to project 46. With S2 pressed, the transistor acts as an amplifier, increasing the current through the speaker. The LED current is lower in this arrangement.



Project 81 LED Keyboard Control

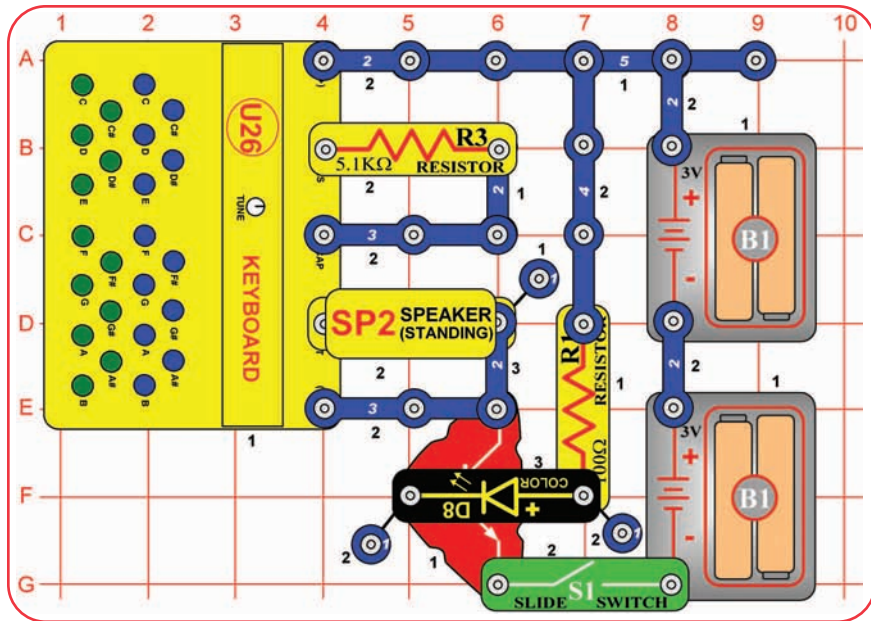

Build the circuit, and turn on the slide switch (S1). You hear a sound pattern that is synchronized with the color LED (D8) flashing. You can press keys on the keyboard (U26) to change the sound.

The color LED turns off briefly when it changes colors. Here the color LED controls the keyboard through the transistor (Q2), so when the color LED turns off, the keyboard sound is also turned off. This produces the sound effects you hear.



Project 82 LED Keyboard Control (II)

Use the preceding circuit, but remove the 5.1k W resistor (R3). Now there is only sound when you press keys on the keyboard, and the sounds for some keys are different.

Project 83 Photo LED Keyboard Control

Use the project 81 circuit, but replace the 5.1k W resistor (R3) with the photoresistor (RP). Wave your hand over the photoresistor or adjust the room lighting to vary the amount of light shining on the photoresistor, and listen to the sounds. You can also press keys on the keyboard (U26) to add more sounds.

Project 84

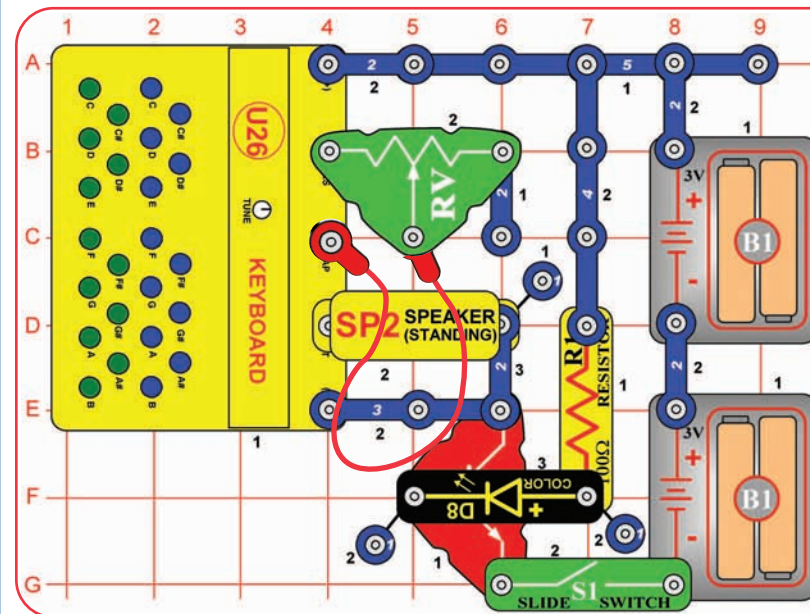

Adjustable LED Keyboard Control

Modify the project 81 circuit to match this one. Turn on the slide switch (S1) and move the lever on the adjustable resistor (RV) to vary the sounds. You can also press keys on the keyboard (U26) to add more sounds.

Project 85 Capacitor Keyboard Control

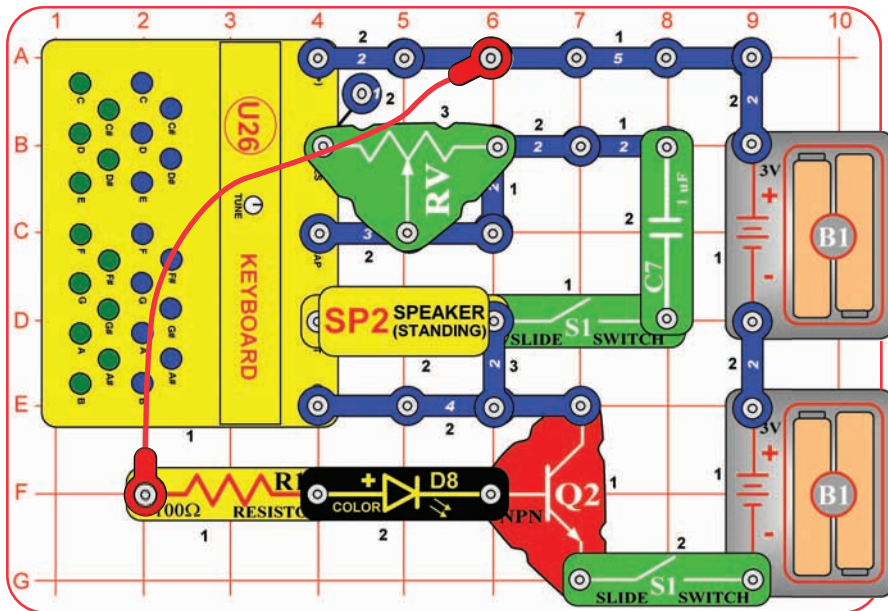

Build the circuit, and turn both slide switches (S1). You hear a sound pattern that is synchronized with the color LED (D8) flashing. Move the lever on the adjustable resistor (RV) to change the sound produced. You can also press keys on the keyboard (U26) to change the sound.

Adding the capacitor changes the range of tones produced by the keyboard.



Project 86 Capacitor Keyboard Control (II)

Use the preceding circuit, but replace the 1mF capacitor (C7) with the 0.1 mF capacitor (C2). The sounds are different now.

Project 87

Voice & Keyboard Echo

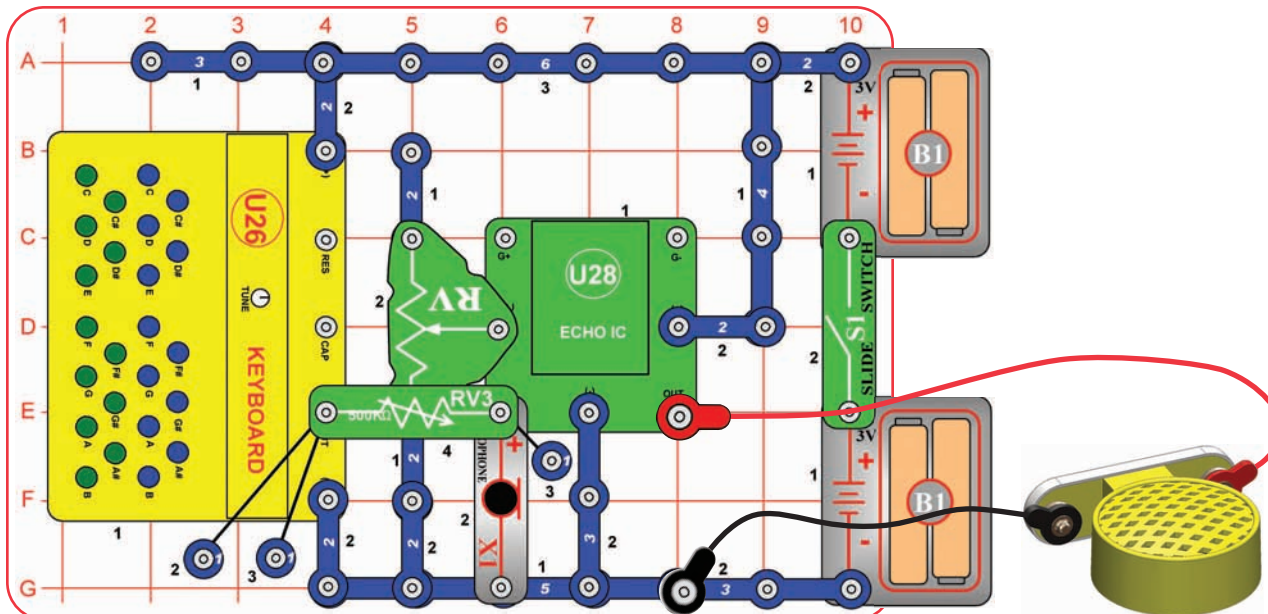

Build the circuit as shown. Place the circuit in a quiet room. Connect the speaker (SP2) using the red & black jumper wires, then hold it away from the microphone (X1). Turn on the slide switch (S1). Talk into the microphone or press keys on the keyboard (U26), and listen the echo on the speaker. Adjust the volume using the knob on RV3. Adjust the amount of echo using the lever on RV; move the lever up for more echo or down for less echo. Try this at different RV settings, because the effects are very interesting with both high and low echo amounts.

Note: You must hold the speaker away from the microphone or the circuit may self-oscillate due to feedback. You also need a quiet room, with low background noise.



Project 88

LED Voice Keyboard Echo

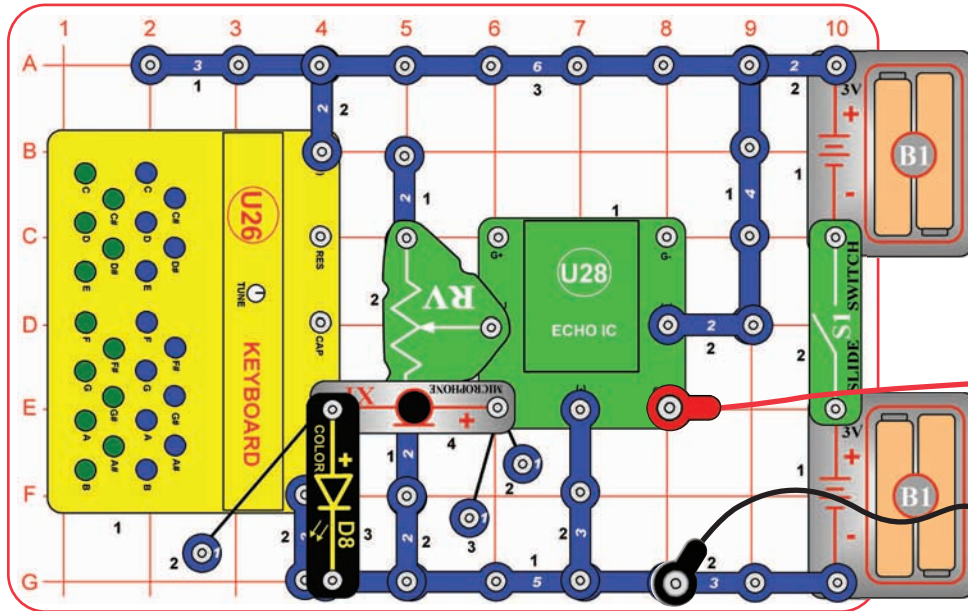

Build the circuit as shown. Place the circuit in a quiet room. Connect the speaker (SP2) using the red & black jumper wires, then hold it away from the microphone. Turn on the slide switch (S1). Talk into the microphone or press keys on the keyboard (U26), and listen the echo on the speaker. Adjust the amount of echo using the lever on the adjustable resistor (RV); move the lever up for more echo or down for less echo. Try this at different RV settings, because the effects are very interesting with both high and low echo amounts.

The color LED (D8) lights when keys are pressed but will be dim. It is easier to see in a dimly lit room.

Note: You must hold the speaker away from the microphone or the circuit may self-oscillate due to feedback. You also need a quiet room, with low background noise.

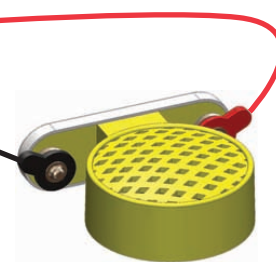

Project 89 Photo LED Keyboard Echo

Use the preceding circuit, but replace the microphone (X1) with the photoresistor (RP). As you are pressing keys on the keyboard (U26), vary the amount of light shining into the photoresistor to change the sound. Try it using different settings on the adjustable resistor (RV).



Project 90 Photo LED Keyboard

Use the preceding circuit, but remove the adjustable resistor (RV) from the circuit. Press keys on the keyboard (U26), and vary the light to the photoresistor (RP) to adjust the volume. There won't be any echo effects now.



Project 91 Audio Dark Light

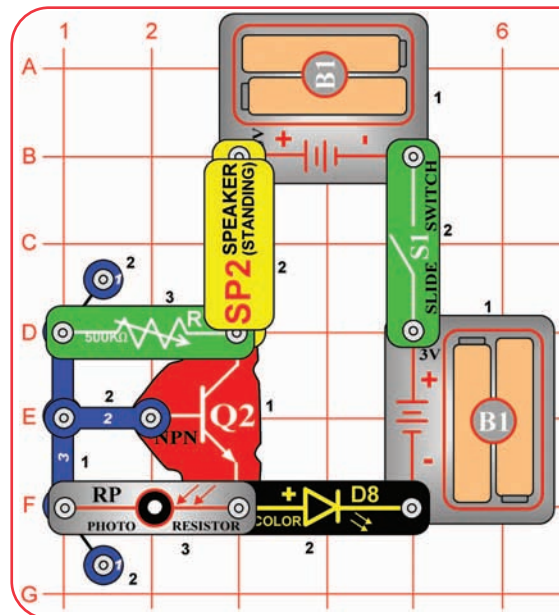

Build the circuit, and turn on the slide switch (S1). Set the knob on the 500k W adjustable resistor (RV3) to the right until the color LED (D8) is off. Cover the photoresistor (RP) or take the circuit into a dark room, and the color LED should turn on, and you hear clicking from the speaker (SP2). The clicking will not be very loud.

Project 92

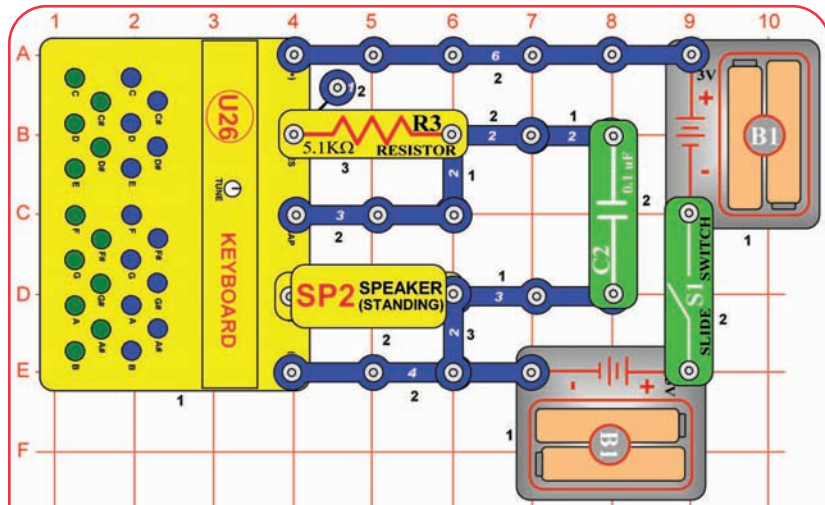

Oscillator

Build the circuit, and turn the slide switch (S1). You hear a tone. You can also press keys on the keyboard (U26) to change the sound.

This circuit is an oscillator, because it produces a repetitive electrical signal on its own. You hear it as sound waves from the speaker. The signal is produced by a circuit inside the keyboard module, but may be controlled using your Snap Circuits® resistors and capacitors, and the keys on the keyboard. The keys are actually connecting different resistors inside the keyboard, similar to the 5.1kΩ resistor (R3).



Project 93 Oscillator (II)

Use the preceding circuit, but replace the 0.1mF capacitor (C2) with the 1mF capacitor (C7). The frequency (pitch) of the sound is lower now.

Project 94 Oscillator (III)

Use the preceding circuit, but replace the 1mF capacitor (C7) with the 470mF capacitor (C5). The frequency of the sound is now so low that you just hear a click every few seconds.

Project 95 Oscillator (IV)

Use the preceding circuit, but replace the 5.1kΩ resistor (R3) with the 100 Ω resistor (R1). The frequency of the sound is higher now, and you hear several clicks a second.

Project 96 Oscillator (V)

Use the preceding circuit, but replace the 470mF capacitor (C5) with the 1 mF capacitor (C7). The frequency of the sound is much higher now, and you hear a continuous tone.

Project 97 Oscillator (VI)

Use the preceding circuit, but replace the 1mF capacitor (C7) with the 0.1 mF capacitor (C2). Do you hear anything? The circuit is producing a high frequency tone, which may be too high for your ears to hear, especially if you are older.

Now remove the 0.1 mF capacitor from the circuit. This makes the tone even higher frequency, and you probably won't hear anything now. Dogs have better high frequency hearing, so maybe your dog can hear it.

Project 98 Left Right Bright Light

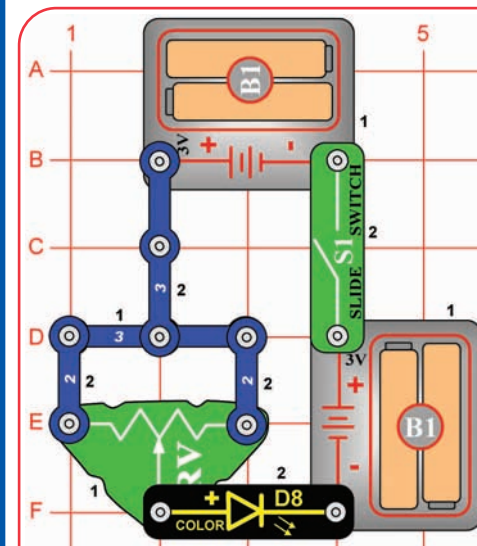

Turn on the slide switch (S1) and move the lever on the adjustable resistor (RV) around. The color LED (D8) is bright if the lever is to the far left or far right, and dim if the lever is in the middle.

Project 99 Adjustable Oscillator

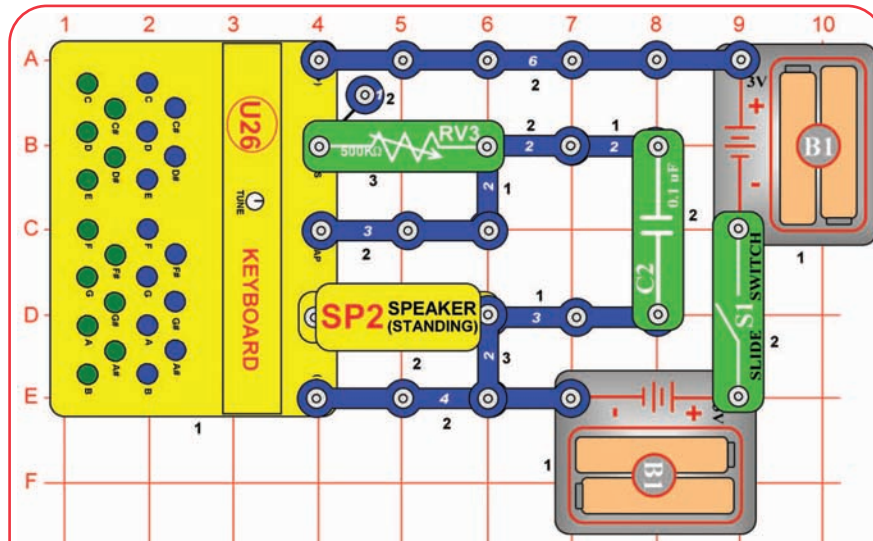

Build the circuit, and turn the slide switch (S1). Turn the knob on the 500k Ω adjustable resistor (RV3) to see the range of sounds that can be produced; there will only be sound for a small part of RV3's range. You can also press keys on the keyboard (U26) to change the sound.



RV's 500k Ω adjustment range is wide, and the oscillator circuit inside the keyboard (U26) won't function over RV's full range. At some settings the circuit may function, but produce too high of frequency for your ears to hear.

Project 100 Adjustable Oscillator (II)

Use the preceding circuit, but replace the 0.1 mF capacitor (C2) with the 1 mF capacitor (C7). The frequency (pitch) of the sound is lower now.

Project 101 Adjustable Oscillator (III)

Use the preceding circuit, but replace the 1mF capacitor (C7) with the 470mF capacitor (C5). You can hear a clicking sound for a small part of RV3's adjustment range.

Project 102 Adjustable Oscillator (IV)

Use the preceding circuit, but remove the 470 mF capacitor (C5) from the circuit. See the range of sounds that this circuit can produce.

Project 103 Water Detector

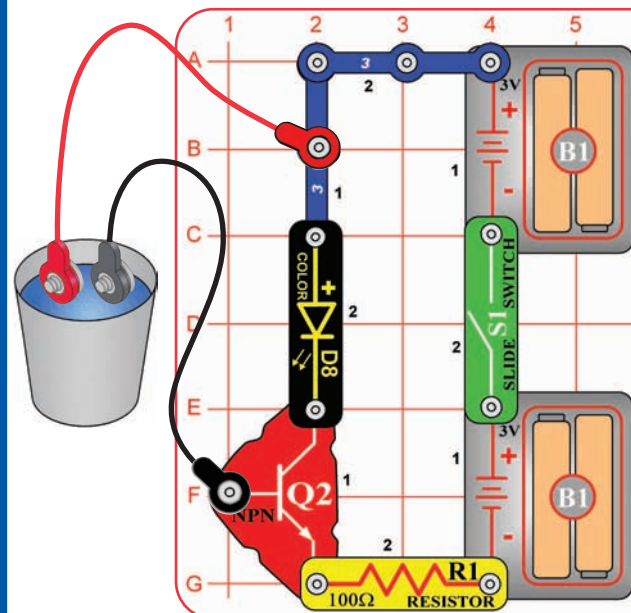

Build the circuit, and initially leave the loose ends of the red & black jumper wires unconnected. Turn on the slide switch (S1); nothing happens. Now place the loose ends of the red & black jumper wires into a cup of water, without their snaps touching each other. The color LED (D8) should be on now, indicating that you have detected water!



Project 104

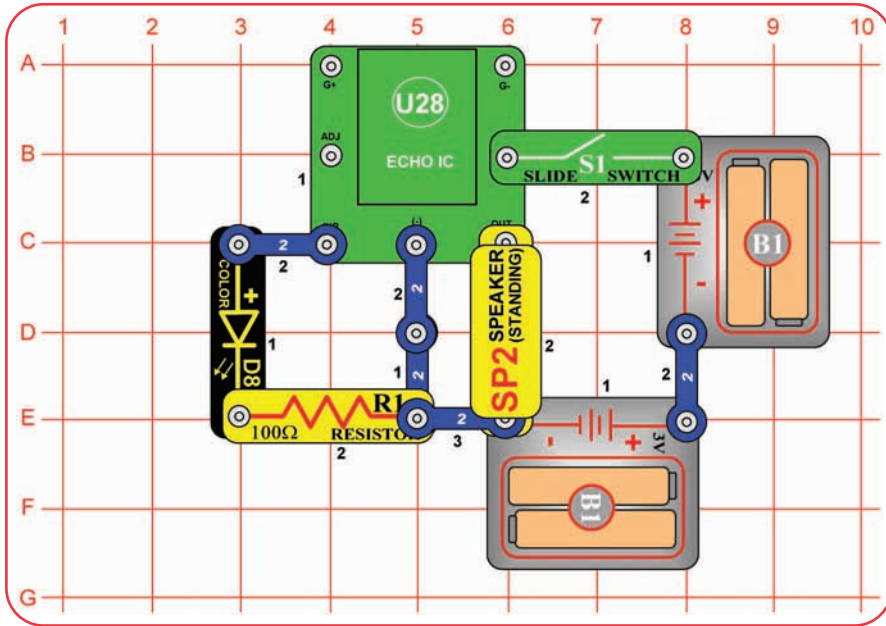

Build the circuit, and turn the slide switch (S1). The color LED (D8) is flashing, and you hear a clicking sound.

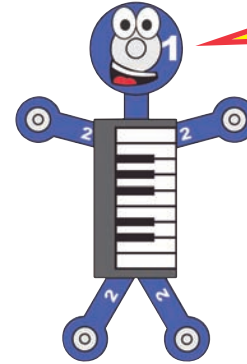

The color LED turns off briefly when it changes colors. What you hear in the speaker is the change in current as the LED turns on or off.



Project 105

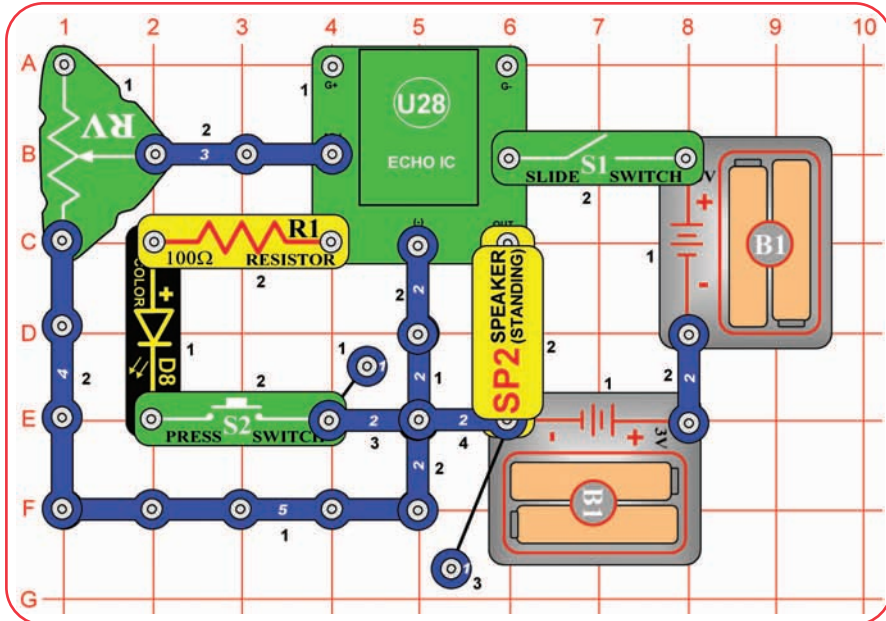

Clicker with Echo

Modify the preceding circuit to be this one, which adds echo effects. Turn on the slide switch (S1) and push the press switch (S2) to see the color LED (D8) flashing and hear a clicking sound. When you release the press switch, the color LED shuts off but you hear echo effects. Use the lever on the adjustable resistor (RV) to set the echo level.



Project 109

Color Sound

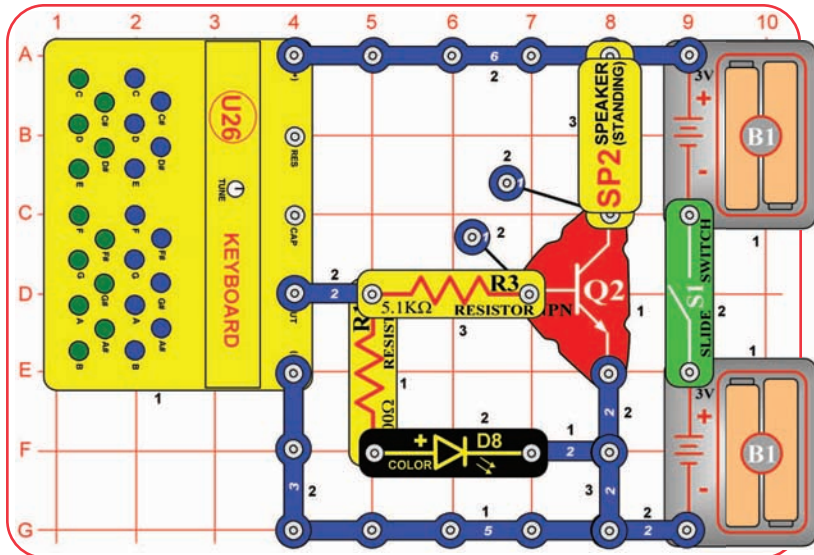

Normally the color LED changes colors, but here it doesn't, why? The U26 keyboard produces a changing voltage, intended to produce sound on the speaker. The color LED is designed for use with a stable voltage (like the batteries); when used with the changing voltage from the keyboard, it gets confused and blurs its pattern.

Red is the easiest color for the color LED to produce, and blue is the hardest. So when the voltage to it is weak, the more difficult colors get dim first.

The keyboard produces separate tones for the blue and green keys, which are played together at the speaker. The two tones also control the color LED. When the tones combine, it is easier for the color LED to produce green and blue color.



Build the circuit and turn the slide switch (S1). Press any key on the keyboard (U26), but just one key at a time. The color LED (D8) lights (mostly red), and you hear a tone from the speaker (SP2).

Now press one blue key and one green key at the same time, to produce 2 tones on the speaker. Watch the color LED (D8) closely; you should see more green and blue color than before. Try viewing it in a dimly lit room.

Now turn the TUNE knob while pressing the blue C key and the green C key at the same time. Slowly turn the knob across its entire range, and see how the LED color changes.

The spectrum of LED color here depends on your batteries. With strong batteries you will see more green and blue. With weak batteries you will mostly see red.



Project 110 Color Sound (II)

Use the preceding circuit, but add the 0.1mF capacitor (C2) over the keyboard (U26) using a 1-snap wire, as shown. Press a blue and a green key at the same time, while turning the TUNE knob. Watch the colors on the color LED (D8), and listen to the sound.

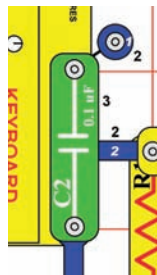

Project 111 Color Sound (III)

Use the preceding circuit, but use the 1 mF capacitor (C7) instead of the 0.1mF capacitor (C2). Press a blue and a green key at the same time, while turning the TUNE knob. Watch the colors on the color LED (D8), and listen to the sound.

Next, replace the 1mF capacitor (C7) instead of the 470 mF capacitor (C5). Press one of the green keys and hold it down. Every few seconds, the color LED flashes and you hear a click from the speaker.



Project 112 Backwards Color Sound

Use any of the 3 preceding circuits, but reverse the direction of the color LED (D8). The circuit works the same, but the sound may not be as loud and the LED may not be as bright.



Normally the color LED doesn't work when you connect it backwards, but in this circuit it does. The changing voltage produced by the keyboard actually goes both ways (positive and negative), so here the color LED will work in either direction.



Project 113

White Light

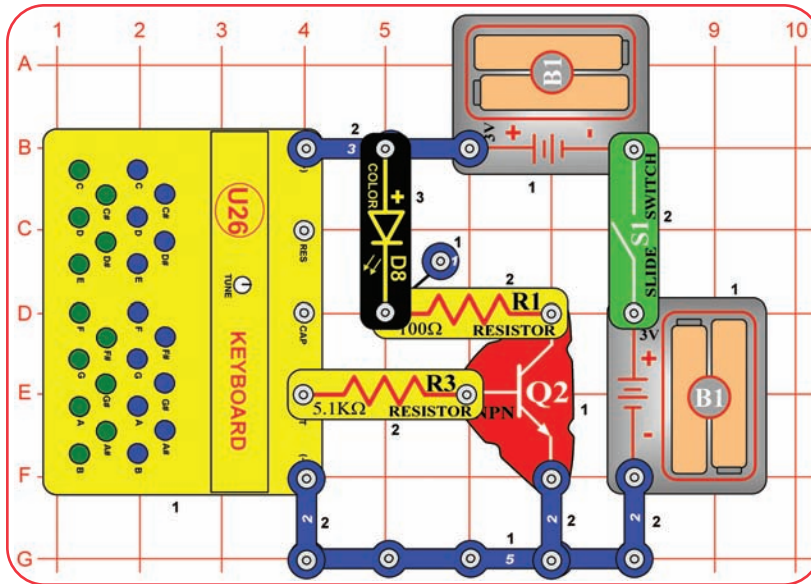

Build the circuit and turn the slide switch (S1). Press any key on the keyboard (U26), but just one key at a time. The color LED appears white, and isn't changing colors like it normally does. If you look closely at the color LED you can see separate red, green, and blue lights on it, which combine to produce white. This is best seen in a dark room. You can also view it with the egg attachment on the color LED, which helps to blend the LED colors together.



The color LED actually contains separate red, green, and blue LED controlled by a microcircuit. It is designed for use with a stable voltage (like the batteries); when used with the keyboard output (a changing voltage intended to produce sound on the speaker), it gets confused and blurs its pattern. The result appears white because mixing equal amounts of red, green, and blue light makes white light.



Project 114 Red to White

Use the preceding circuit, but replace the 5.1k W resistor (R3) with the 500kW adjustable resistor (RV3). Press any key on the keyboard (U26), but just one key at a time. Slowly turn the knob on RV3 from right to left across its range while watching the color LED (D8) closely. Notice how first red gets bright, then green too, then also blue. This is best seen in a dark room. You can also try it with the egg attachment on the color LED.

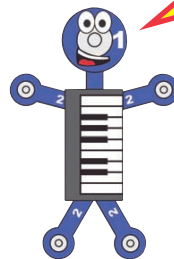
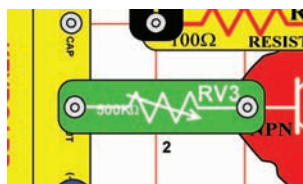

RV3 controls the voltage to the color LED, through transistor Q2. When the voltage is low, the color LED only produces red, since that is the easiest color for it to produce. As the voltage increases, green light is added, then blue.



Project 115

Alarm

Build the circuit with the black jumper wire connected as shown, and turn it on. Nothing happens. Disconnect the jumper wire and an alarm sounds.

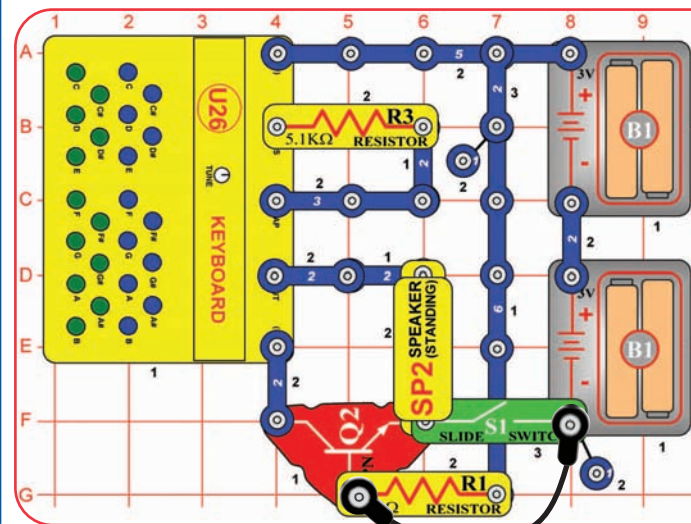

You could replace the jumper wire with a longer wire and run it across a doorway to signal an alarm when someone enters.

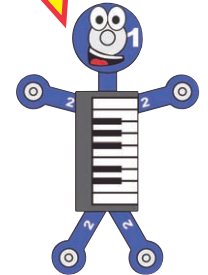

Project 116 Super Voice Echo with Light

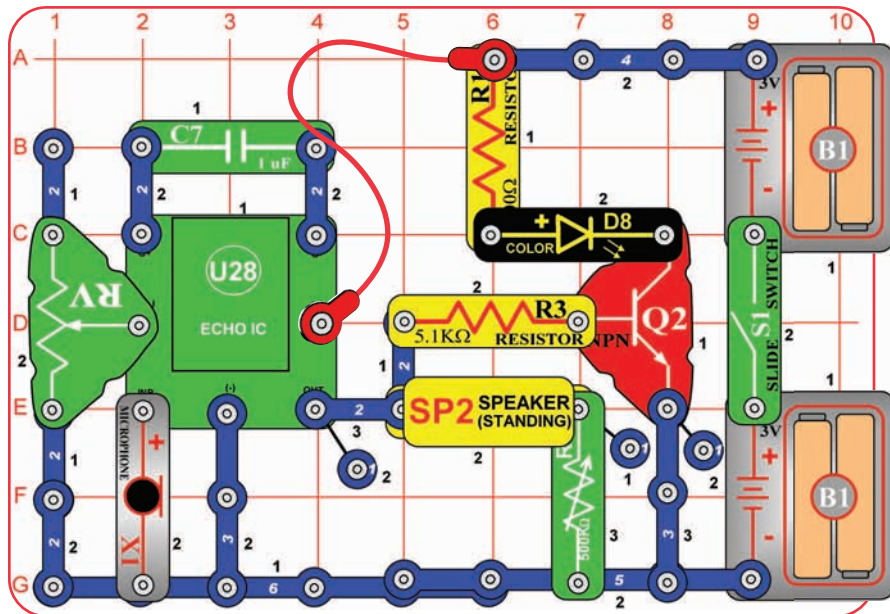

Build the circuit as shown, and turn on the slide switch (S1). Talk into the microphone, and listen the echo on the speaker, and see it on the color LED (D8). Set the sound volume using the knob on the 500k W adjustable resistor (RV3). Adjust the amount of echo using the lever on the adjustable resistor (RV).

Note: There will only be sound if RV3 is set towards the left (most of its range will have no sound). Also, at the loudest RV3 setting the circuit may oscillate and make a whining sound; just set the RV3 volume a little lower to stop it.

Project 117 Press Echo

Use the preceding circuit, but replace the microphone (X1) with the press switch (S2). Set RV3 to max volume (turn it to the left). Press S2 to see light on the color LED (D8), and hear a clicking sound from the speaker (SP2).

Project 118 Photo Echo

Use the preceding circuit, but replace the press switch (S2) with the photoresistor (RP). Adjust the amount of light shining on the photoresistor to change the sound and light.

Project 119 Loud Press Photo Echo

Use the circuit from project 1 17 (with S2) or 1 18 (with RP), but replace RV3 with a 3-snap wire. The sound will be louder but the light will be dimmer.

Project 120

Knob Echo

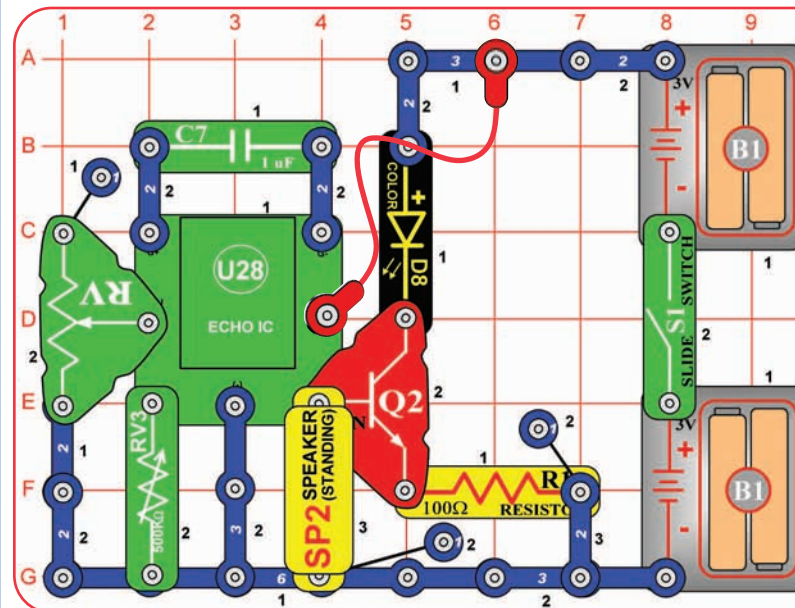

Build the circuit as shown, turn on the slide switch (S1), and turn the knob on the 500k W adjustable resistor (RV3). You hear clicking in the speaker (SP2), and the color LED (D8) flashes. Adjust the amount of echo using the lever on the adjustable resistor (RV). Try this at different RV settings.

If you remove the speaker (SP2) from the circuit then the color LED (D8) will be a little brighter, because the echo IC (U28) isn't trying to control the speaker at the same time.

Project 121

Echo Light Headphone

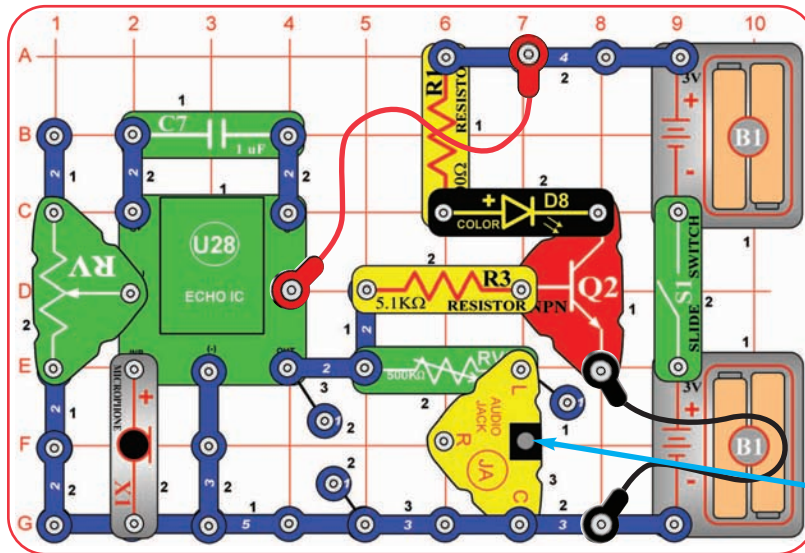

Build the circuit as shown, and connect your own headphones (not included) to the audio jack (JA). Turn on the slide switch (S1).

Talk into the microphone, and listen the echo on your headphones, and see it on the color LED (D8). Set the 500k adjustable resistor (RV) for most comfortable sound level (turn to the left for higher volume, most of RV's range will be very low volume); then adjust the amount of echo using the lever on the adjustable resistor (RV). Only the left side of your headphones will have sound.



WARNING: Headphones performance varies, so use caution. Start with low volume, then carefully increase to a comfortable level. Permanent hearing loss may result from long-term exposure to sound at high volumes.

Headphones
(not included)



Project 122 Echo Light Headphone Variants

Use the preceding circuit, but replace the microphone (X1) with the press switch (S2). Press S2 to see light on the color LED (D8), and hear a clicking sound from your headphones.

Next, replace the press switch with the photoresistor (RP). Adjust the amount of light shining on the photoresistor to change the sound and light.

You can use a stereo speaker (not included) instead of headphones. When using it with the microphone (X1), you may need to lower the volume to prevent feedback into the microphone.

Project 123

Press Echo Light

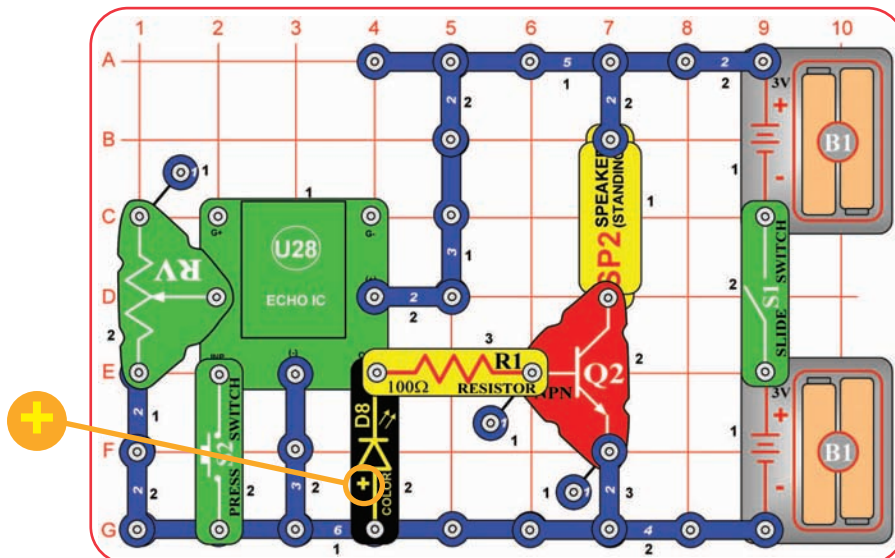

Build the circuit as shown, and turn on the slide switch (S1). Push the press switch (S2) to see light on the color LED (D8), and hear a clicking sound from the speaker (SP2). Adjust the amount of echo using the lever on the adjustable resistor (RV).

Project 124 Photo Echo Light

Use the preceding circuit, but replace the press switch with the photoresistor (RP). Adjust the amount of light shining on the photoresistor to change the sound and light. You may need a big difference in brightness to notice the effects.

Next, replace the photoresistor with the microphone (connect the "+" side to the echo IC (U28)). Talk loudly directly into the microphone to flash the light and hear your voice on the speaker (SP2), but your voice will be badly distorted.



Project 125

Another Voice Echo Light

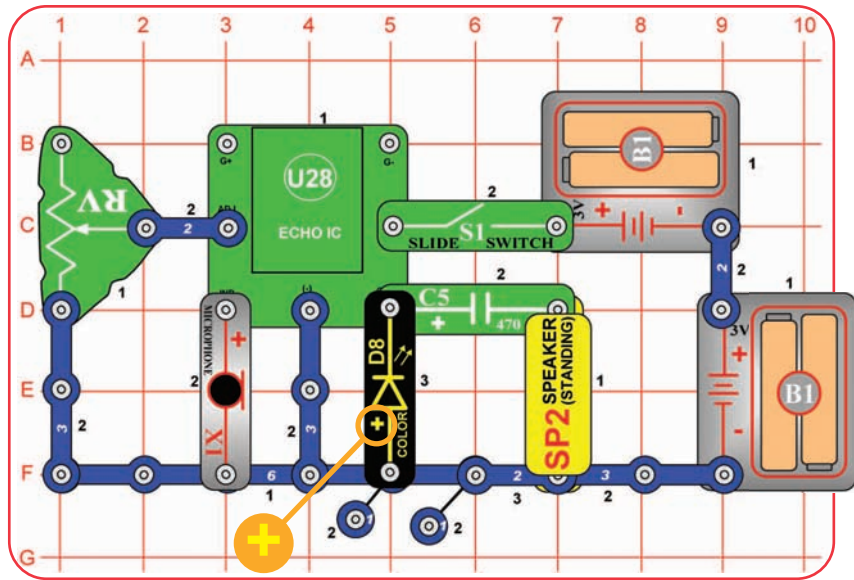

Build the circuit as shown, and turn on the slide switch (S1). Talk into the microphone (X1) to light the color LED (D8) and hear your voice on the speaker (SP2). Adjust the amount of echo using the lever on the adjustable resistor (RV).

Next, replace the microphone with the press switch (S2). Push the press switch to see light on the color LED, and hear a clicking sound from the speaker.



Project 126

Daylight Voice Echo

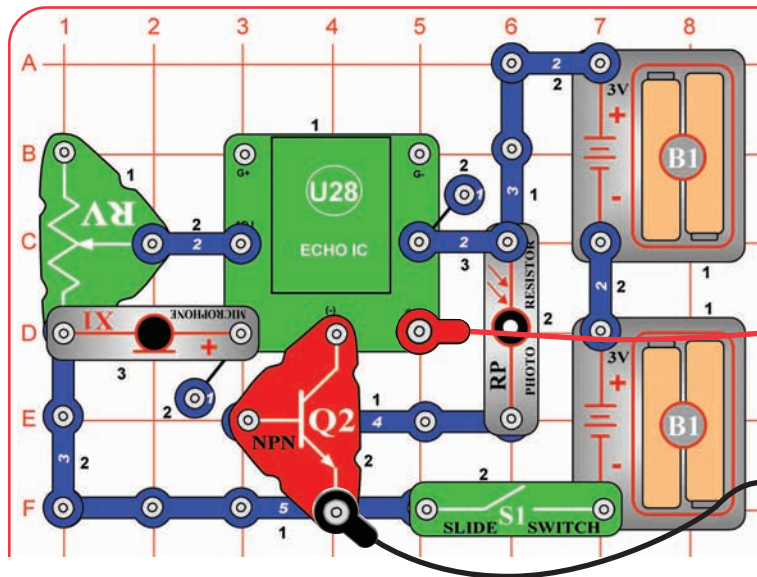

Note that there is a 4-snap wire under Q2, partially hidden. Place the circuit in a quiet room with bright light shining into the photoresistor (RP). Connect the speaker (SP2) using the red & black jumper wires, then hold it away from the microphone (X1). Turn on the slide switch (S1). If the speaker makes a whining sound that does not stop, then you need brighter light on the photoresistor, or the room is too noisy.

Talk into the microphone, and listen the echo on the speaker. Now block the light to the photoresistor to turn off the circuit; slowly wave your hand over it to turn the echo on and off. You can adjust the amount of echo using the lever on the adjustable resistor (RV).

The photoresistor controls power to the echo IC (U28), and acts as an on/off switch. If there is some light on it but not bright light, it may only partially turn on the echo IC, causing the echo IC to malfunction.

Also, you must hold the speaker away from the microphone or the circuit may self-oscillate due to feedback. You also need a quiet room, with low background noise.

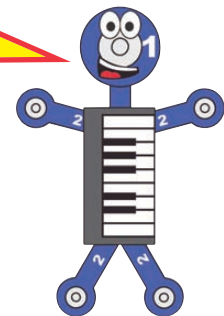

Project 127

Dark Voice Echo

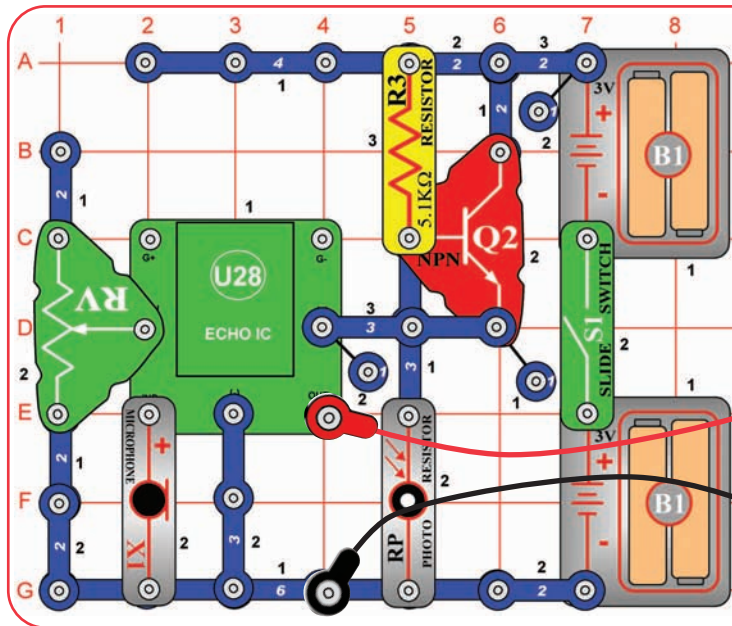

The photoresistor controls power to the echo IC (U28), and acts as an on/of switch. If the photoresistor is not dark enough, it may only partially turn on the echo IC, causing the echo IC to malfunction.

Also, you must hold the speaker away from the microphone or the circuit may self-oscillate due to feedback. You also need a quiet room, with low background noise.



Build the circuit as shown, and place it in a quiet room. Connect the speaker (SP2) using the red & black jumper wires, then hold it away from the microphone (X1). Turn on the slide switch (S1); nothing will happen unless the room is dark. This circuit only works if there is no light on the photoresistor (RP).

Cover the photoresistor, talk into the microphone, and listen the echo on the speaker. You can adjust the amount of echo using the lever on the adjustable resistor (RV). Shine light on the photoresistor to shut off the circuit.

If the speaker makes a whining sound that does not stop, then you need to block light from the photoresistor better, or the room is too noisy.

Project 128

Dark Echo Light

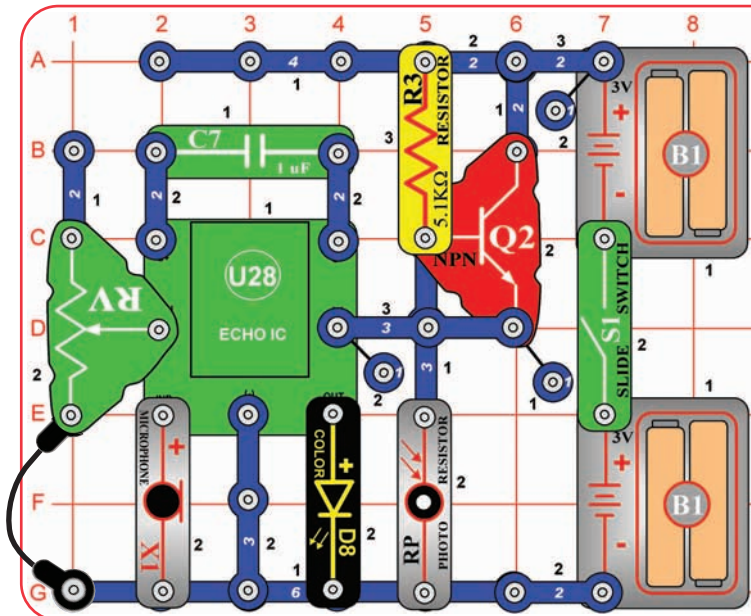

Modify the preceding circuit to match this one; it uses the color LED (D8) instead of the speaker (SP2). Turn on the slide switch (S1); nothing will happen unless the room is dark. This circuit only works if there is no light on the photoresistor (RP).

Cover the photoresistor, talk into the microphone, and see the light flash. You can adjust the amount of echo using the lever on the adjustable resistor (RV). Shine light on the photoresistor to shut off the circuit.

If the color LED never turns on, then you need to block light from the photoresistor better.

Project 129 Dark Echo Variants

Use either of the preceding two circuits, but replace the microphone (X1) with the press switch (S2) or 500kΩ adjustable resistor (RV3). Press S2 or turn the knob on RV3 to change the sound or light.

Project 130

Day Echo Light

Project 131

Day Echo Variants

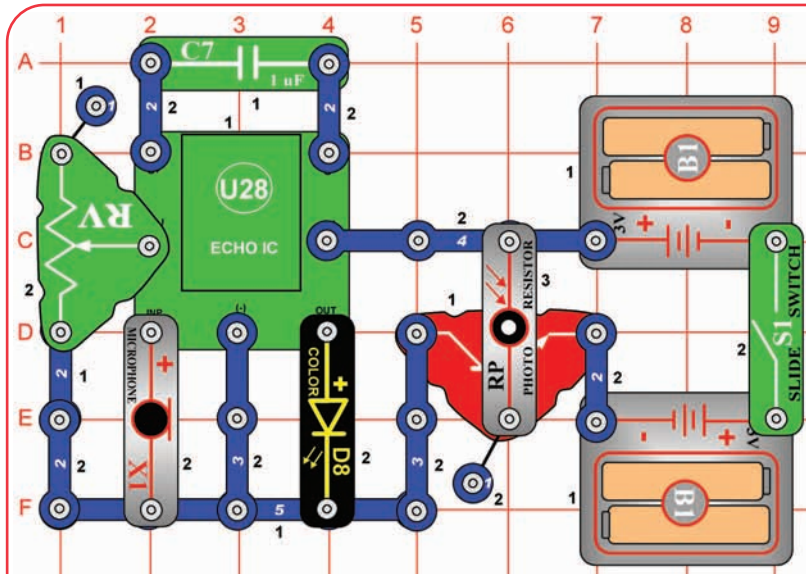

Build the circuit as shown, and place it where there is bright light shining into the photoresistor (RP). Turn on the slide switch (S1). If the color LED never turns off, then you need brighter light on the photoresistor.

Talk into the microphone, and see the color LED (D8) flash. Now block the light to the photoresistor to turn off the circuit; slowly wave your hand over it to turn the echo on and off while talking. You can adjust the amount of echo using the lever on the adjustable resistor (RV).

Use the preceding circuit, but replace the microphone (X1) with the press switch (S2) or 500k adjustable resistor (RV3). Press S2 or turn the knob on RV3 to change the light.

You can also replace the color LED (D8) with the speaker (SP2). When used with the microphone, you must connect the speaker using the red & black jumper wires and hold it away from the microphone, and also omit C7.

Project 132

Photo Light Timer

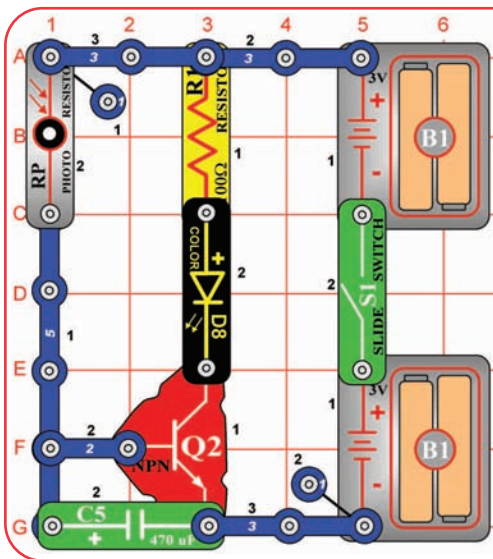

Build the circuit, and turn on the slide switch (S1). If there is light on the photoresistor (RP) then the color LED (D8) will be on. Block the light to the photo-resistor, and the color LED should slowly get dimmer and dimmer.

The 470mF capacitor (C5) stores up some electricity, and releases it when you block the light.



Project 133

Adjustable Photo Light Timer

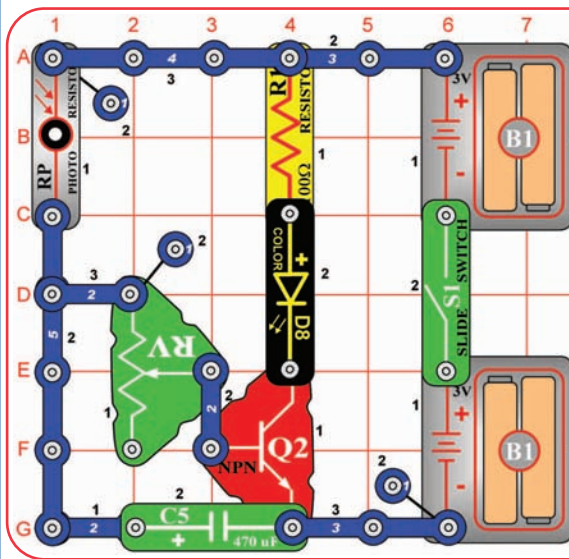

This circuit is similar to the preceding one, except the color LED (D8) stays on longer when you block the light to the photoresistor (RP). Use the lever on the adjustable resistor (RV) to set how long the color LED will stay bright after the photoresistor is covered.

The resistance of R slows down the discharging of the 470 mF capacitor (C5).





Project 134

Tone Stoppers

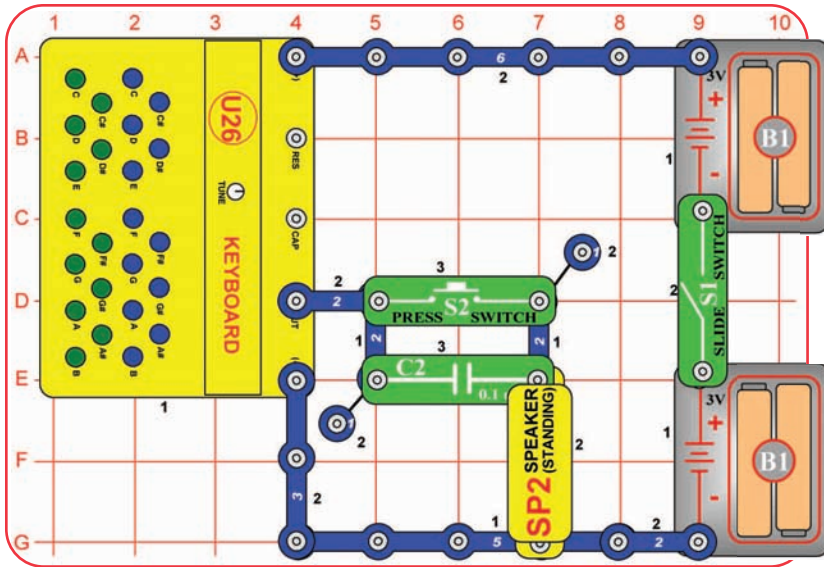

Build the circuit and turn the slide switch (S1). Press any key on the keyboard (U26). You hear a tone from the speaker (SP2), though it may not be very loud.

Now push the press switch (S2) while pressing the same key . The sound is louder now , because the press switch bypassed the 0.1 mF capacitor.



Capacitors can store electricity in small amounts. This storage ability allows them to block stable electrical signals and pass changing ones, making them useful in filtering and delay circuits. Capacitors with higher values have more storage capacity, and can pass changing signals more easily

In this circuit the 0.1mF capacitor blocks most of the keyboard tone signal. You can hear the difference when you press S2 to bypass the capacitor.



Project 135 Tone Stoppers (II)

Use the preceding circuit, but replace the 0.1 mF capacitor (C2) with the larger 1 mF capacitor (C7). Compare the sound volume to the preceding circuit.

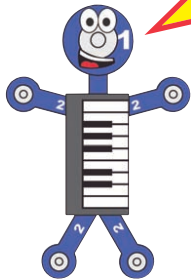

The sound is a little louder now because the larger 1 mF capacitor passes more of the tone than the smaller 0.1mF capacitor did.



Project 136 Tone Stoppers (III)

Use the preceding circuit, but replace the 1mF capacitor (C7) with the much larger 470mF capacitor (C5). Compare the sound volume to the preceding circuits. How much difference does pressing S2 make now?

The sound is much louder now because the larger 470 mF capacitor passes much more of the tone than the smaller 1mF capacitor did. Now pressing S2 does not increase the sound, because C5 is already passing all of it.



Project 137 Tone Stoppers (IV)

Use the circuit from project 135 (with the 1mF capacitor (C7)), but add the 500kΩ adjustable resistor (RV3) as shown here. Slowly turn RV3's knob to vary the pitch (frequency) of the tone from lowest to highest possible (there will only be sound for a small part of RV3's range). At the same time, press S2 on and off several times, to see how C7 is changing on the sound.

Next, replace C7 with smaller C2 or larger C5, and compare the capacitor's effect as you vary the tone frequency.



C7 will give less change on high frequency tones than on low frequency tones; you should be able to notice the difference as you vary the tone using RV3. The smaller C2 will affect both high and low tones a lot. The larger C5 will have little effect on both high and low tones.

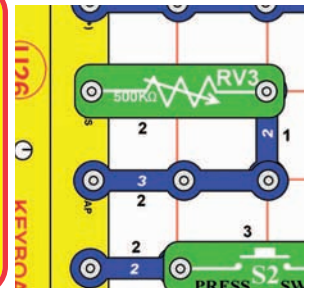

Project 138 Tone Stoppers (V)

Project 139 Alarm Light

Alarm Light

In project 137, there is only sound for a small part of RV3's range, which can be difficult to tune. To help, modify the circuit to add the adjustable resistor (RV) in series with RV3, as shown. Slowly adjust RV and RV3 to vary the tone from lowest to highest possible, while pressing S2 on and off, to see how the capacitors (C7, or C2 or C5) change the sound.

You can also replace RV3 with the photoresistor (RP). Set RV to the left, and then adjust the tone by varying the light to RP, while comparing the effects of the capacitors.

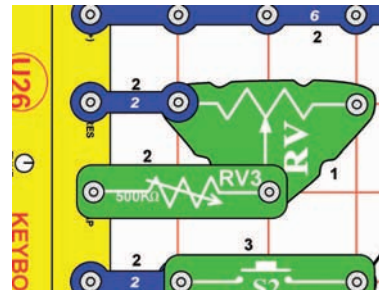

RV is more sensitive and can be adjusted from 200W to 50k W, compared to 200W to 500k W for RV3.

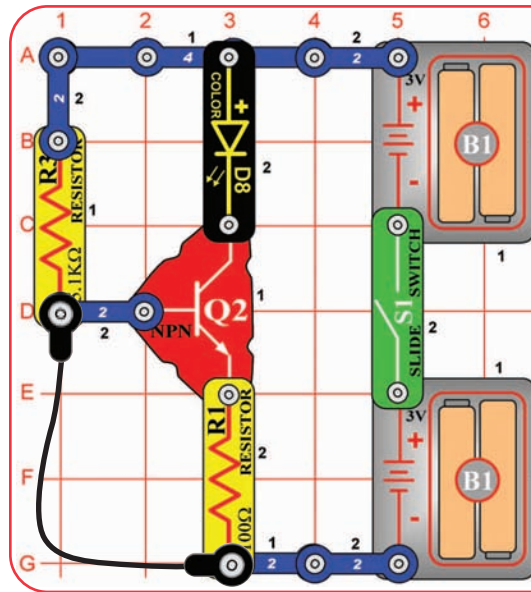

Build the circuit with the black jumper wire connected as shown, and turn it on. Nothing happens. Disconnect the jumper wire and the color LED (D8) comes on, signalling an alarm.

Project 140

Voice Changer with Headphones

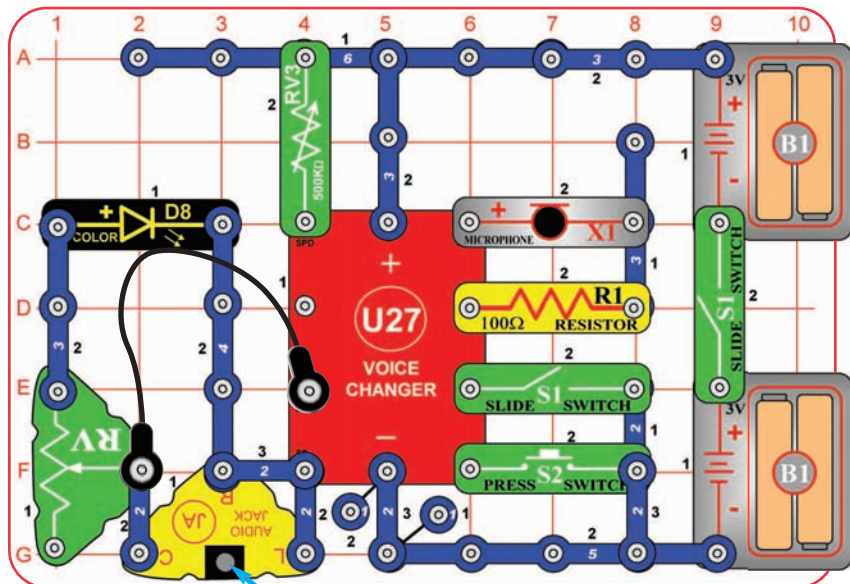

Headphones or Stereo Speaker (not included)

This project requires stereo headphones or a stereo speaker (neither included); connect them to the audio jack (JA). Set the 500k W adjustable resistor (RV3) to mid-range. Turn on both slide switches (S1), you hear a beep signaling that you may begin recording. Talk into the microphone until you hear a beep (signaling that recording time is over), then turn off the left slide switch to exit recording mode. Push the press switch (S2) to play back the recording and flash the color LED (D8), and turn the knob on RV3 to change the playback speed. You can play your recording faster or slower by changing the setting on RV3.

Adjust the volume to your headphones or stereo speaker using the lever on the adjustable resistor (RV).

Recording time is 6 seconds at normal speed, but this can be changed depending on the setting of RV3 when you are making the recording.



WARNING: Headphones performance varies, so use caution. Start with low volume, then carefully increase to a comfortable level. Permanent hearing loss may result from long-term exposure to sound at high volumes.



Project 141

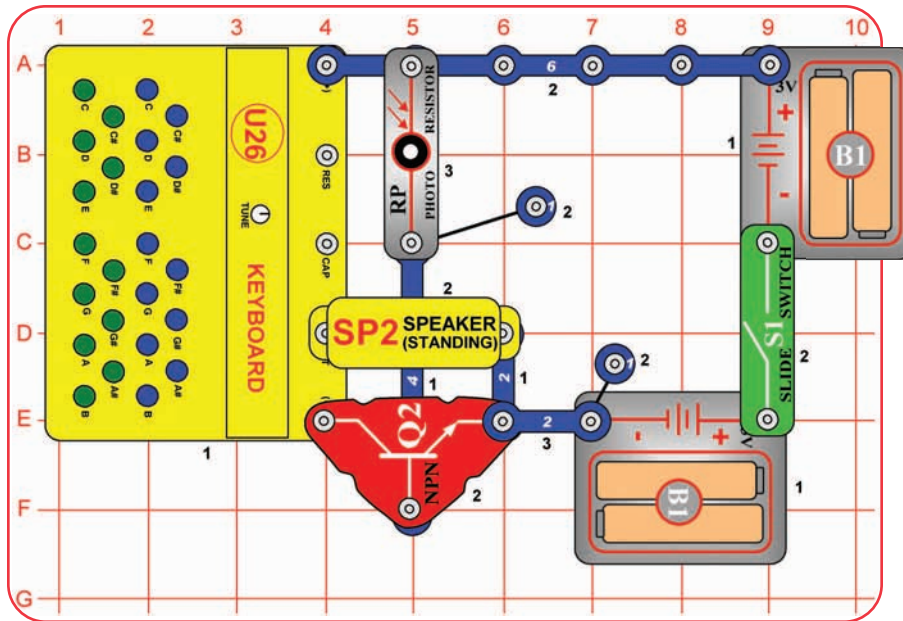

Day Keyboard

Build the circuit (note that there is a 4-snap wire under Q2, partially hidden) and turn the slide switch (S1). Press keys on the keyboard (U26). This keyboard only works during the day, so you have to have light on the photoresistor or there won't be any sound. If you cover the photoresistor or place the circuit in a dark room then it won't work. If the light is dim then the sound may be abnormal.



Project 142

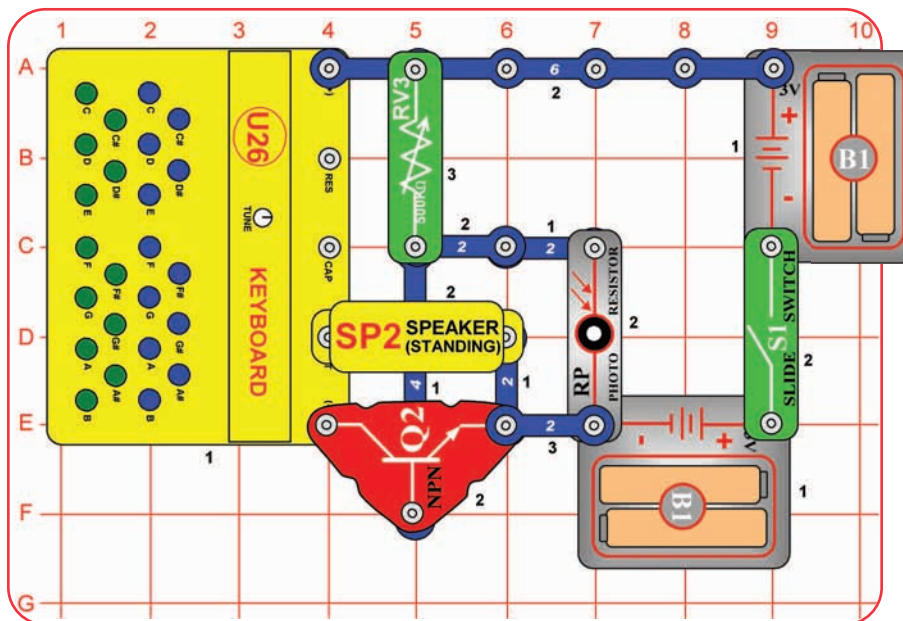

Night Keyboard

Build the circuit (note that there is a 4-snap wire under Q2, partially hidden) and turn the slide switch (S1). Press any key on the keyboard (U26) and set the 500kW adjustable resistor so the sound just shuts of. Now block the light to the photoresistor (RP) and press some keys to play tones.



Project 143

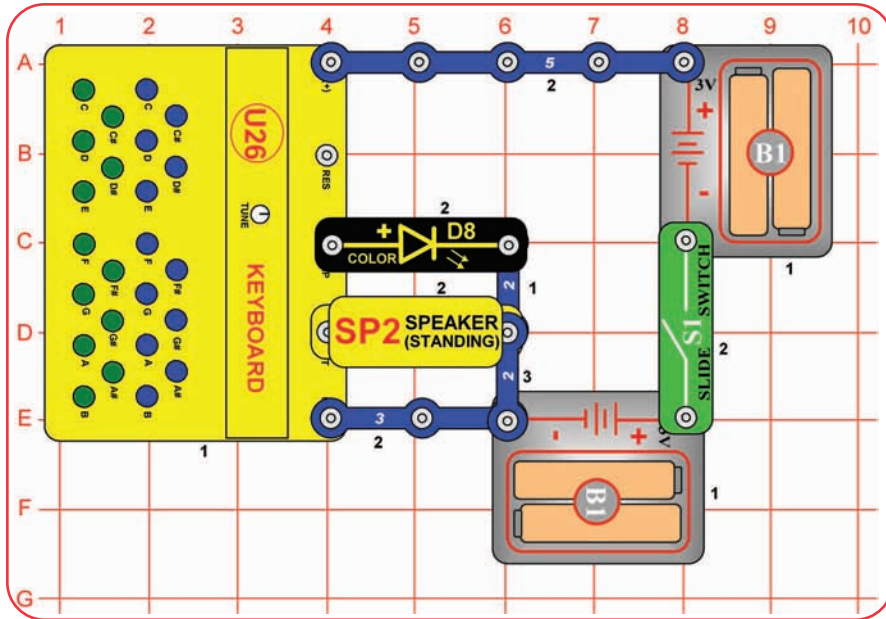

Color Keyboard

Build the circuit and turn the slide switch (S1). Press and hold down any green key on the keyboard (U26), and see what happens.

Project 144 Color Keyboard (II)

Modify the preceding circuit by adding the adjustable resistor (RV) as shown here. Turn the slide switch (S1). Move the lever on the adjustable resistor around; best effects are when it is to the left. Press keys on the keyboard (U26) at the same time. You will see some cool effects.

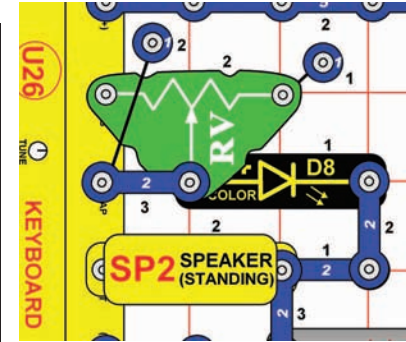

Project 145

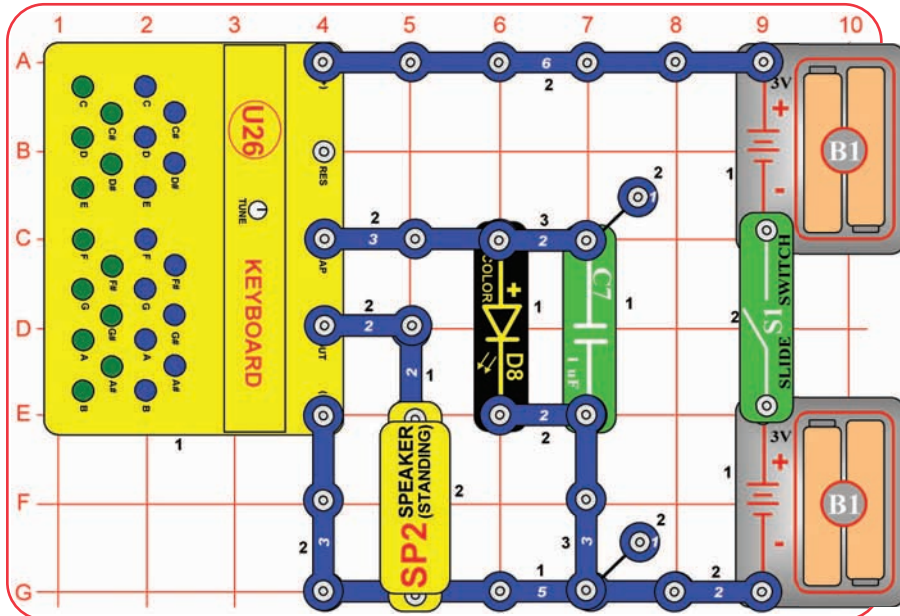

Color Keyboard (III)

Build the circuit and turn the slide switch (S1). Press and hold down any green key on the keyboard (U26), and see what happens.

Project 146 Color Keyboard (IV)

Modify the preceding circuit by adding the 100W resistor (R1) and replacing the 1 mF capacitor (C7) with the 470mF capacitor (C5), as shown here. Turn the slide switch (S1) to see some cool effects. Press any of the blue keys for more effects. Pressing the green keys won't do anything.

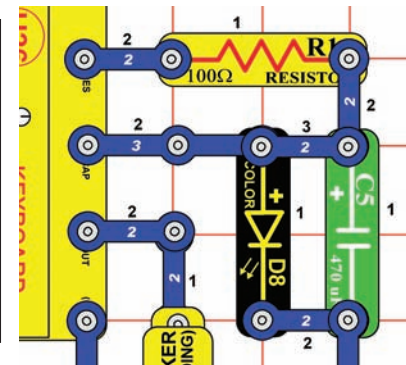

Project 147

Color Keyboard (V)

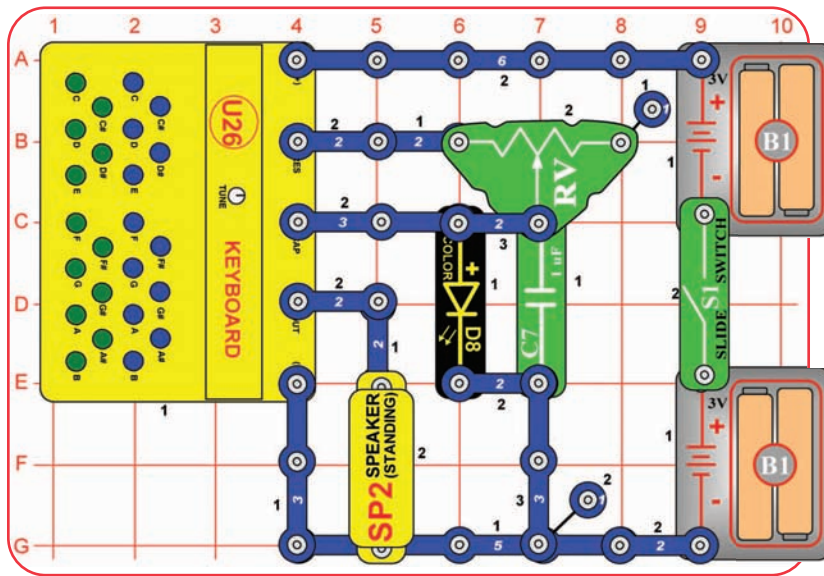

Turn on the slide switch (S1). Move the lever on the adjustable resistor (RV) around near the left (not the middle or right). Press any of the blue keys for more effects. Pressing the green keys may not do anything.

Project 148 Color Keyboard (VI)

Use the preceding circuit, but replace the 1mF capacitor (C7) with the 0.1mF capacitor (C2). The sound is a little different now, and the green keys can change it.

Project 149 Adjustable Voice Changer & Light

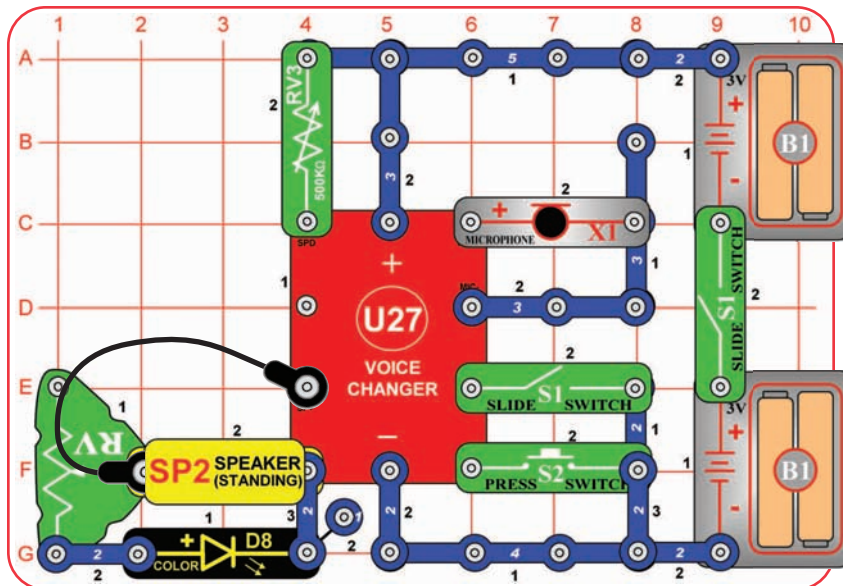

Set the 500kΩ adjustable resistor (RV3) to mid-range. Turn on both slide switches (S1), you hear a beep signaling that you may begin recording. Talk into the microphone until you hear a beep (signaling that recording time is over), then turn off the left slide switch to exit recording mode. Push the press switch (S2) to play back the recording, and turn the knob on RV3 to change the playback speed. You can play your recording faster or slower by changing the setting on RV3.

Move the lever on the adjustable resistor (RV) to change the brightness of the color LED (LED) during playback. Most of RV's range will give little or no LED brightness.

Recording time is 6 seconds at normal speed, but this can be changed depending on the setting of RV3 when you are making the recording.

Project 150 Adjustable Voice Changer & Light (II)

Use the preceding circuit, but swap the locations of the speaker (SP2) and color LED (D8). Now the color LED is at full brightness during playback, and RV adjusts the sound volume.



Project 151

Play Fast

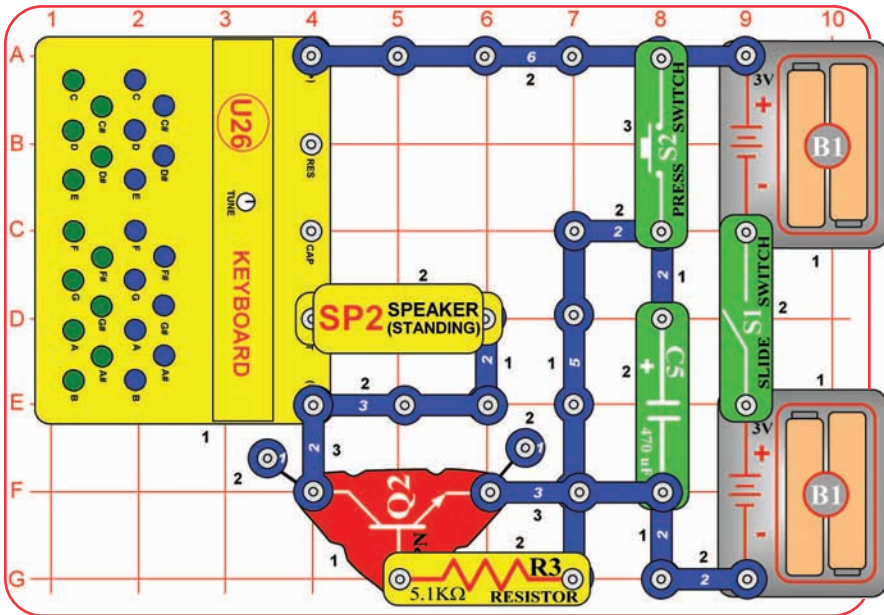

Build the circuit and turn the slide switch (S1). Push the press switch (S2) and play keys on the keyboard (U26). Play fast, because this keyboard will only work for a few seconds! Push S2 again to restart the keyboard and its timer.



Project 152

Red First

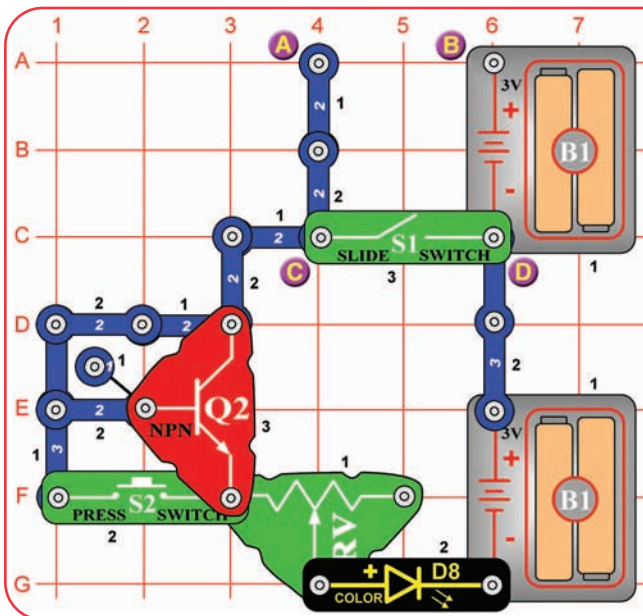

The voltage needed to turn on an LED depends on the light color. Red needs the least voltage, and blue needs the most. With S1 at points C & D and S2 of f, the voltage to the color LED is lowest, and may barely be enough to turn on the red color. Pressing S2 bypasses the NPN transistor (Q2), and boosts the LED voltage a little. Shifting S1 to points A & B increases the circuit voltage from 3V to 6V, making the LED work for a greater part of RV's range.

Turn on the slide switch (S1). Set the lever on the adjustable resistor (RV) all the way to the left. The color LED (D8) should be on, but may be mostly red. Slowly move the lever on RV to the right until the LED is completely off. Notice that the red color stays on the longest.

Now push the press switch (S2) and adjust RV again, watching the LED colors. Blue and green color may also appear now, but may go dim before red does.

Now move S1 from the points marked C & D to the points marked A & B. Move RV's lever around again, watching the LED colors and brightness. Try pushing S2 again, but it won't make as much difference now.



Project 153 Adjustable Timer Tone

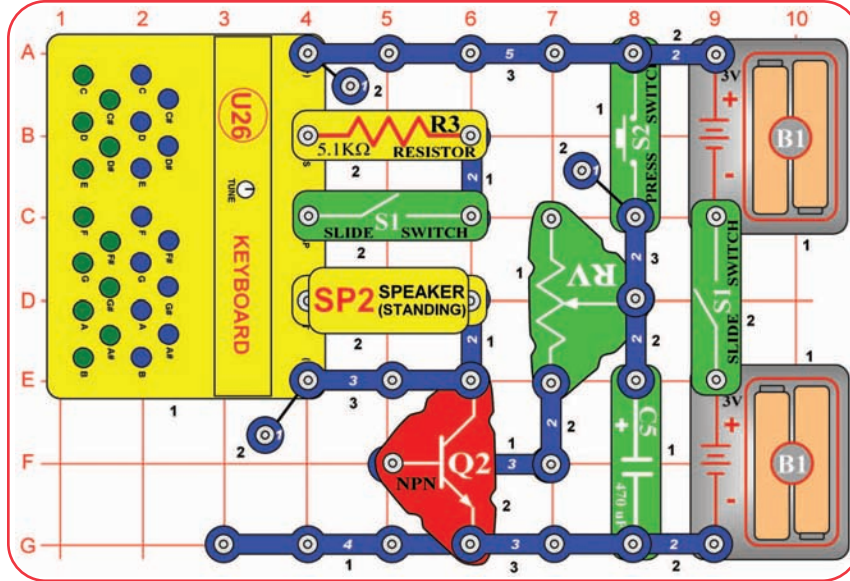

Note that there is a 3-snap wire under Q2, partially hidden. Turn on both slide switches (S1) and push the press switch (S2). You hear a tone, which turns off after a while. Push S2 again to restart the keyboard and its timer. Use the adjustable resistor (RV) to set how long the timer keeps the sound on for, it can be set for a few seconds or very long. You can change the tone that plays by pressing keys on the keyboard (U26).

Turning off the left slide switch turns off the tone, but not the keys or timer.

Project 154 Photo Timer Tone

Use the preceding circuit, but replace the 5.1k W resistor (R3) with the photoresistor (RP). The circuit works the same way, but you can vary the pitch of the tone by adjusting the amount of light on the photoresistor.

Project 155 Delay Lamp

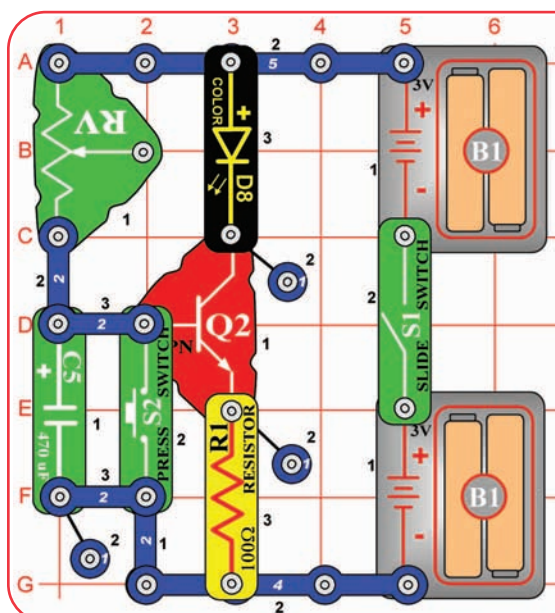

Push and release the press switch (S2), then turn on the slide switch (S1). Nothing happens at first, but after a few seconds the color LED (D8) turns on. Press S2 to turn off D8 and reset the delay timer.

The adjustable resistor (RV) is used as a fixed resistor, and moving its lever won't have any effect.

This circuit works because capacitor C5 can store electricity. When you turn on the circuit, electricity flows through resistor RV into C5. When C5 gets full, electricity starts flowing into transistor Q2, which turns on the color LED. Pressing S2 empties C5, and resets the timer. Capacitors C2 and C7 also store electricity, but only small amounts; if used in this circuit they would appear to fill up instantly.

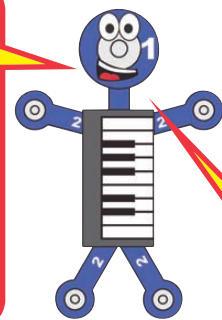

Project 156 Adjustable Delay Lamp

Use the preceding circuit, but replace adjustable resistor (RV) with the 500kW adjustable resistor (RV3). Set the knob on RV3 to different positions, press S2 to start the timer, and see how long it takes for the color LED to turn on. Turning RV3's knob clockwise gives longer delay, turning counter clockwise gives shorter delay.

RV3 controls how fast electricity flows into capacitor C5. Increasing RV3's value makes it take longer to charge up C5.

Project 157

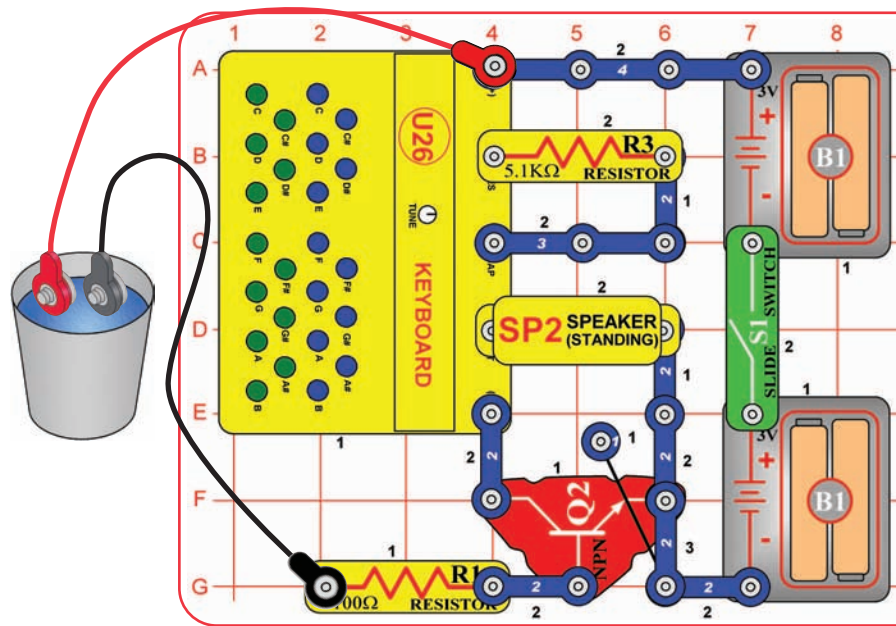

Build the circuit, and initially leave the loose ends of the red & black jumper wires unconnected. Turn on the slide switch (S1); nothing happens. Now place the loose ends of the red & black jumper wires into a cup of water, without their snaps touching each other. You should hear a tone now, indicating that you have detected water!

Don't drink any water used here.

You could place this circuit in your basement, then it will sound an alarm if your basement starts to flood during a storm.



Water Alarm

Project 158 Continuity Tester

Use the preceding circuit, but instead connect the loose ends of the jumper wires to different materials in your home. If you hear sound, then the material you tested has low resistance and is a good conductor of electricity.

Project 159

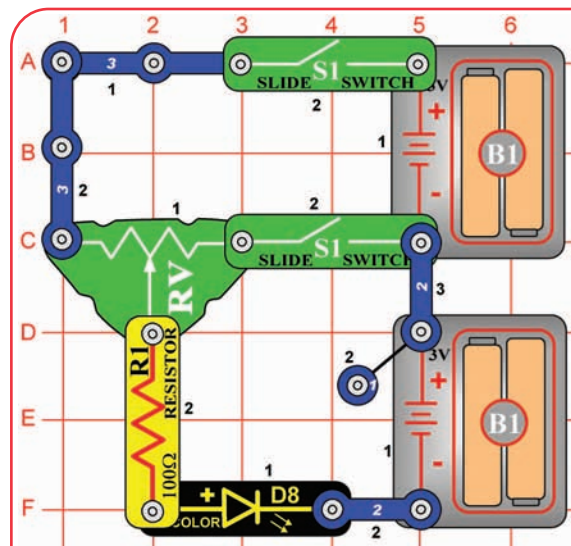

The left side of RV is connected to 6V, while the right side is only connected to 3V, so the color LED will be brighter when RV's lever is to the left. Moving the lever toward the middle increases the resistance in the circuit, and the higher voltage left side will be less affected than the right side.



High Low Light

Turn on both slide switches (S1). Move the lever on the adjustable resistor (RV) all the way to the left or right, and watch the brightness of the color LED (D8). The light should be a little brighter when RV's lever is to the left.

Now move RV's lever toward one side, but not all the way. There should be a larger difference between the same positions on the left compared to the right.

Project 160

Flicker Clicker

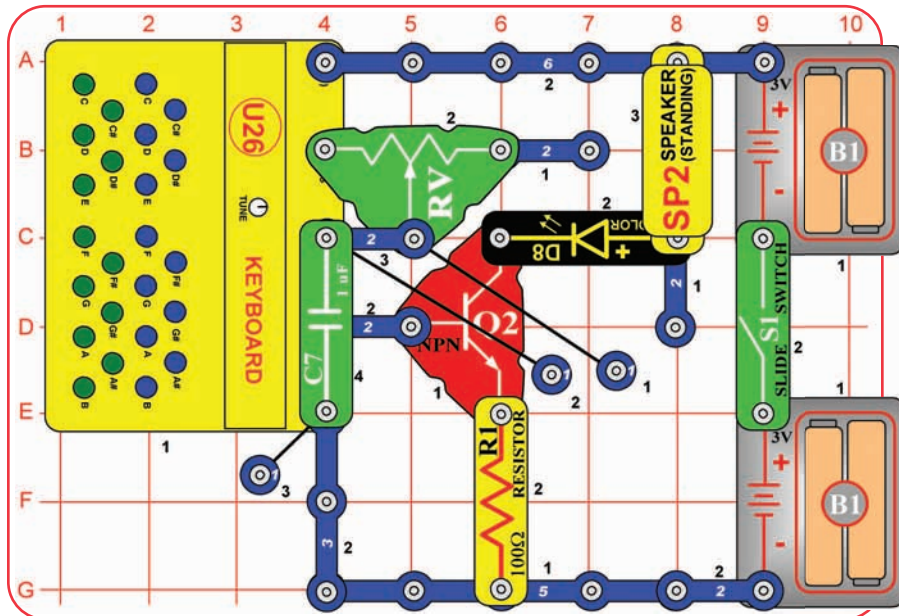

Turn on the slide switch (S1). Move the lever on the adjustable resistor (RV) around to make the color LED (D8) flicker and make clicking or buzzing on the speaker (SP2). Press keys on the keyboard (U26) for more fun effects. Try pressing a blue key and a green key at the same time, while moving R V's lever around.

Project 161

Fast Flicker Clicker

Use the preceding circuit, but replace the 1mF capacitor (C7) with the smaller 0.1mF capacitor (C2). It works the same way but the tone has higher pitch, and the color LED may appear to be on continuously.

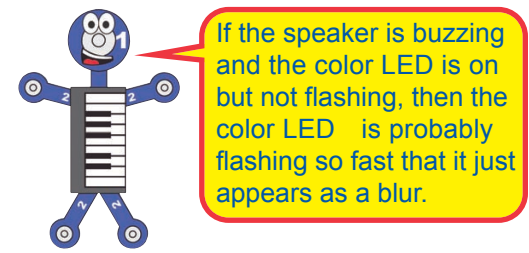

Project 162

Slow Flicker Clicker

Use the preceding circuit, but replace the 1mF capacitor (C7) with the larger 470mF capacitor (C5). With R V set to the left, the LED flashes and the speaker clicks about once a second. As you move R V's lever toward the right, the time between flashes/clicks increases and can get very long. Also try holding down one of the blue keys; best effects are when RV is set toward the left.

Project 163

Timer Tone

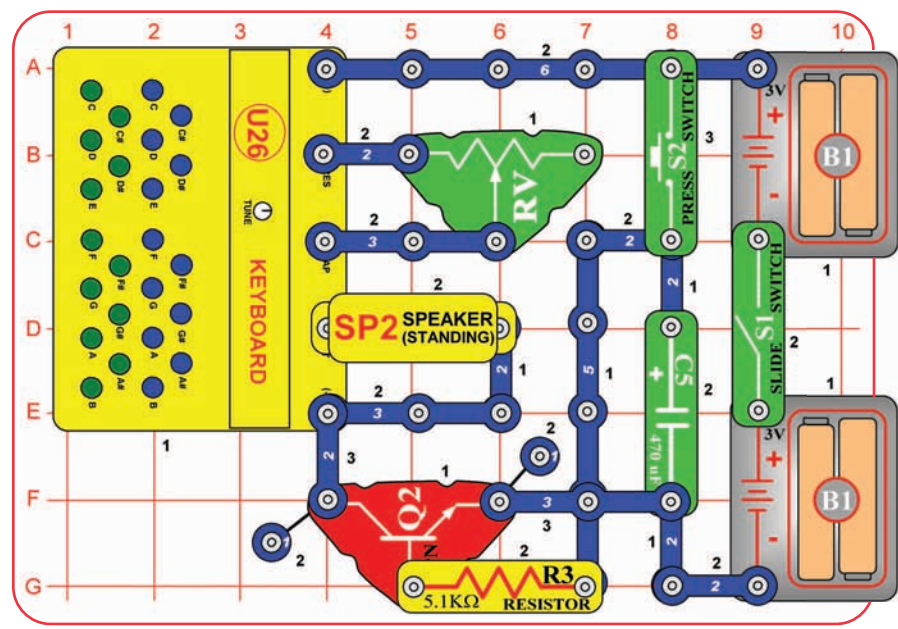

Turn on the slide switch (S1) and push the press switch (S2). You should hear a tone; adjust its pitch using the adjustable resistor (R V). The tone shuts off after about 10 seconds. Push S2 again to re-start the keyboard and its timer.

Some settings on R V may not produce any sound. Press S2 and set RV to where you hear sound.

Project 164

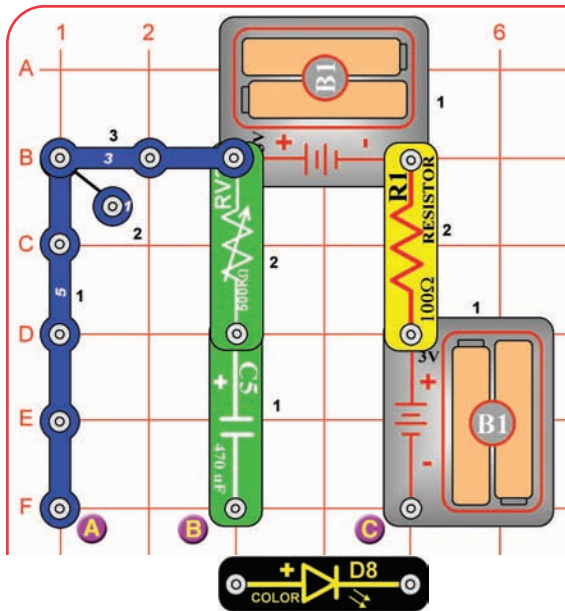

Little Battery

Set the knob on the 500k W adjustable resistor (RV3) to the left. Place the color LED (D8) across the points marked B & C (“+” to B); the LED lights as the capacitor charges. Next, place the color LED across points A & B (“+” to A) instead; now the LED lights as the capacitor discharges. Move the color LED back to B & C and repeat. Use the knob on R V3 to vary the charge / discharge rate, but keep it close to the left (otherwise the LED would be too dim to see).

The capacitor is storing energy like a little battery.



Batteries can hold a lot more electricity than capacitors because batteries store chemical energy while capacitors store electrical energy.

Project 165 Tiny Battery

Use the preceding circuit, but replace the 470mF capacitor (C5) with the smaller 1 mF capacitor (C7). Set RV3 all the way to the left. Place the color LED across B & C to charge C7, then across A & B to discharge it. The LED will only flash for a moment, because C7 can't store much electricity (C5 holds 470 times more). The LED is easier to see in a dimly lit room.

Project 166

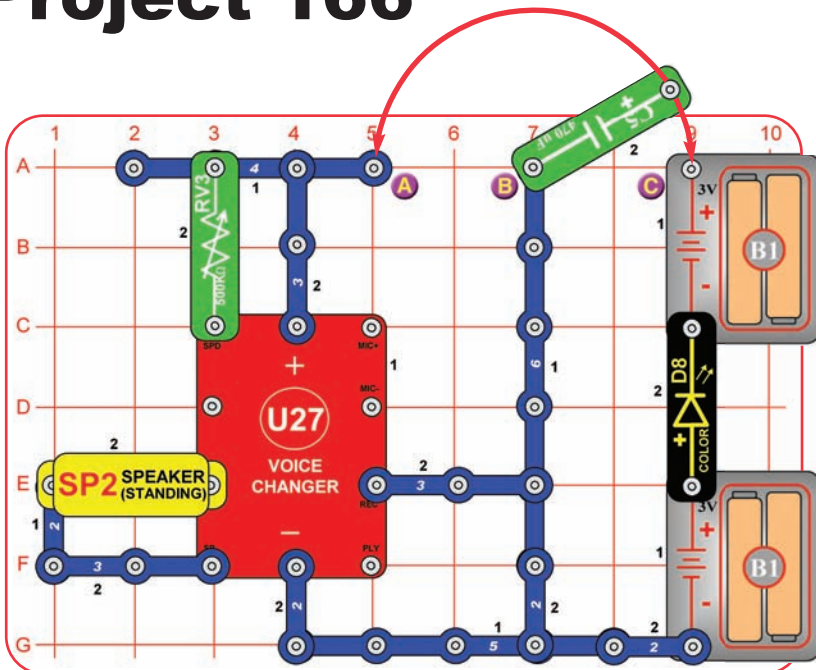

Little Battery Beep

The capacitor is storing energy like a little battery. The “beep” you hear is the voice changer (U27) entering recording mode, but you can't make any recording with this circuit. Capacitor C5 can't store enough electricity to operate the voice changer circuit, but it can power it long enough to make a beep.

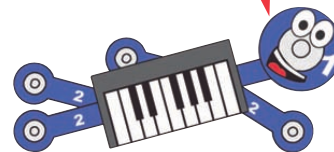

Set the knob on the 500kW adjustable resistor (RV3) to mid-range. Place the 470mF capacitor (C5) across the points marked B & C (“+” to C), then SWING its “+” side around to point A (without unsnapping it from point B). Swing its “+” side between points C & A several times.

When the capacitor (C5) touches point C, the color LED (D8) flashes to show that the batteries charged up the capacitor. When the capacitor touches point A, you hear beep from the speaker (SP2) to show that the audio circuit discharged the capacitor.

You can change the “beep” sound a little by turning the knob on RV3.

Project 167

Capacitors in Series

Project 168 Capacitors in Series (II)

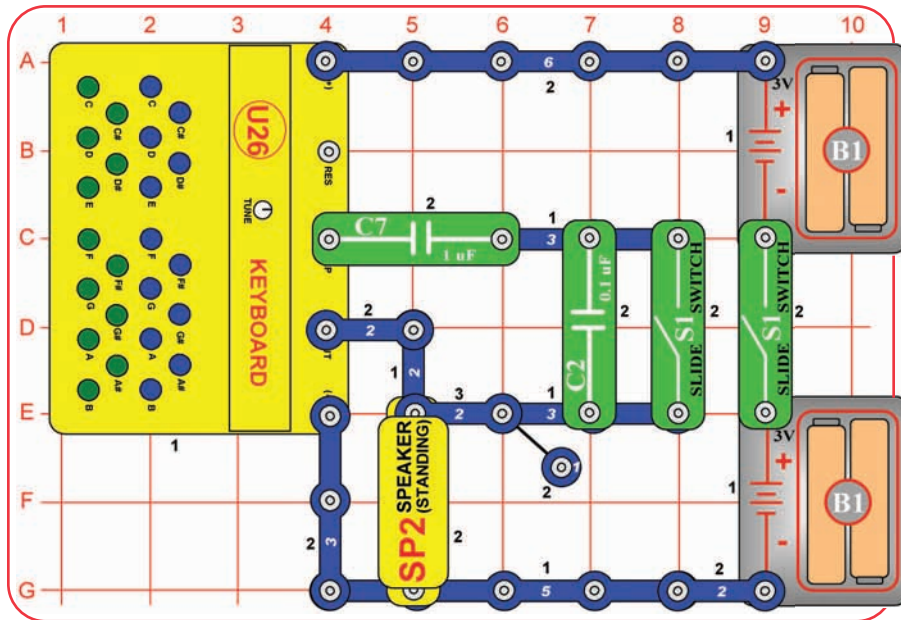

Turn on the right slide switch (S1). Press any green key and compare the sound with the left slide switch on or off.

With the left switch off, the 0.1mF and 1mF capacitors (C2 & C7) are connected in series. Turning on the left switch bypasses the 0.1mF capacitor. Notice that having the 0.1mF included has a big effect on the tone.

Think of capacitors as storage tanks for electricity. If you place a small storage tank in series with a big one, electricity flows into both at the same time, but the small one fills up quickly and stops the flow.

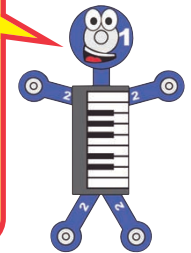

Use the preceding circuit, but swap the locations of the 0.1 mF and 1 mF capacitors (C2 & C7). Press any green key and compare the sound with the left slide switch on or off.

The tone does not change nearly as much as in the preceding circuit. When capacitors are connected in series, the smaller value dominates the circuit.

Project 169 Capacitors in Series (III)

Project 170 More Capacitors in Series

Use the project 167 circuit, but replace the 0.1mF capacitor (C2) with the much larger 470 mF capacitor (C5). Press any green key and compare the sound with the left slide switch on or off.

Now the tone is the same whether the left switch is on or off, because connecting the large 470 mF in series with the small 1mF has little effect on the total capacitance.

Swap the locations of the 1 mF and 470 mF capacitors (C7 & C5). Press any green key and compare the sound with the left slide switch on or off (When the switch is off, hold down the key, because you will only hear a click every few seconds.) Now turning on the left switch has a big effect on the circuit, because connecting the small 1mF in series with the large 470 mF greatly increases the total capacitance.

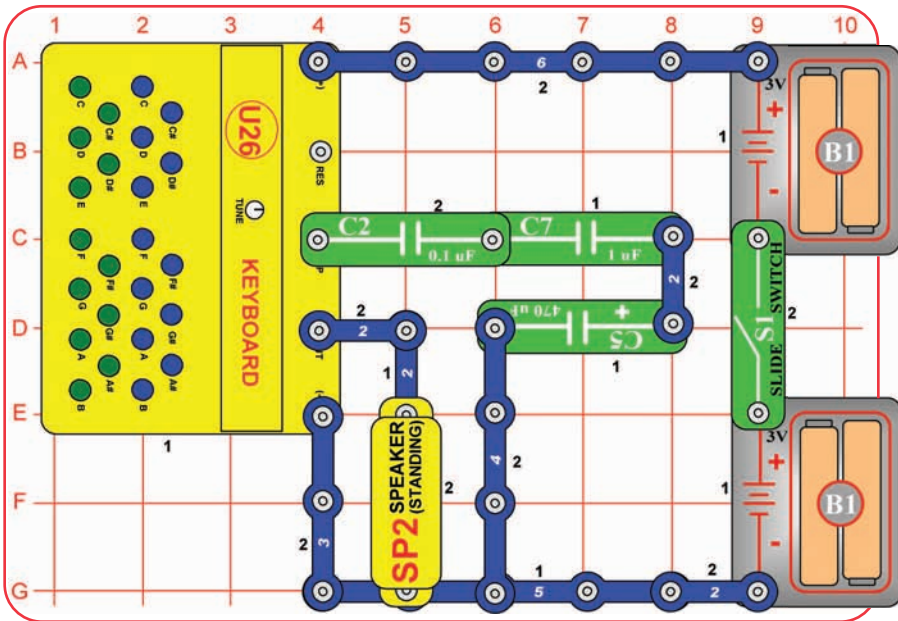

Turn on the right slide switch (S1). Press any green key and compare the sound when you remove one or two of the capacitors (C2, C5, and C7) and replace them with a 3-snap wire. You will only hear a click every few seconds if C5 is the only one in the circuit.

Project 171

Capacitors in Parallel

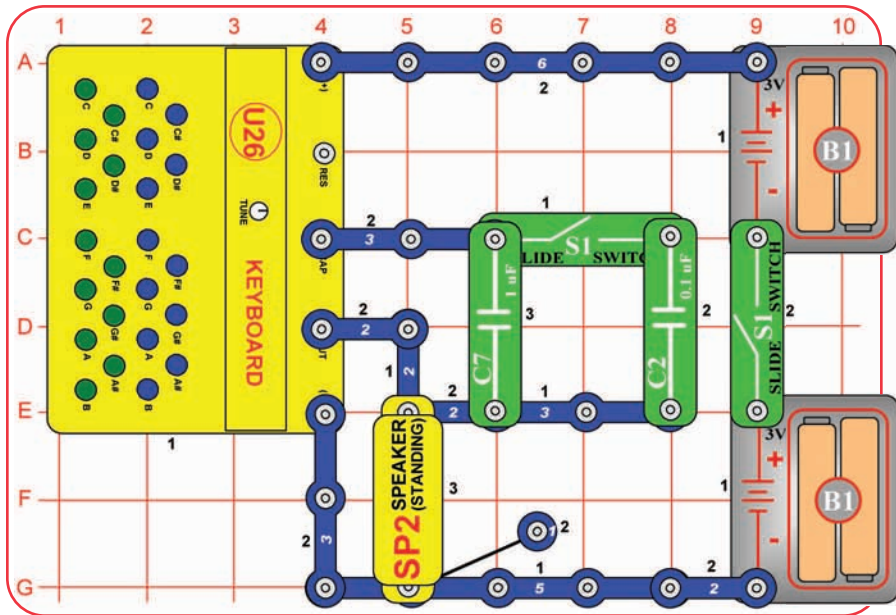

Turn on the right slide switch (S1). Press any green key and compare the sound with the left slide switch on or off.

With the left switch on, the 0.1 mF and 1 mF capacitors (C2 & C7) are connected in parallel. Turning off the left switch disconnects the 0.1mF capacitor. Notice that having the 0.1mF included has only a small effect on the tone.

Think of capacitors as storage tanks for electricity. If you place a large storage tank in parallel with a big one, electricity flows into both at the same time, but keeps flowing until both are full.



Project 172 Capacitors in Parallel (II)

Use the preceding circuit, but swap the locations of the 0.1 mF and 1mF capacitors (C2 & C7). Press any green key and compare the sound with the left slide switch on or off.

The tone changes much more now than in the preceding circuit. When capacitors are connected in parallel, the larger value dominates the circuit.

Project 173 Capacitors in Parallel (III)

Use the project 171 circuit, but replace the 0.1 mF capacitor (C2) with the much larger 470 mF capacitor (C5). Press any green key and compare the sound with the left slide switch on or off. (When the switch is on, hold down the key, because you will only hear a click every few seconds.)

Turning on the left switch has a big effect on the circuit, because connecting the large 470 mF in parallel with the small 1mF greatly increases the total capacitance.

Swap the locations of the 1 mF and 470mF capacitors (C7 & C5). Press any green key and compare the sound with the left slide switch on or of f, because connecting the small 1mF in parallel with the large 470mF has little effect on the total capacitance.

Project 174 More Capacitors in Parallel

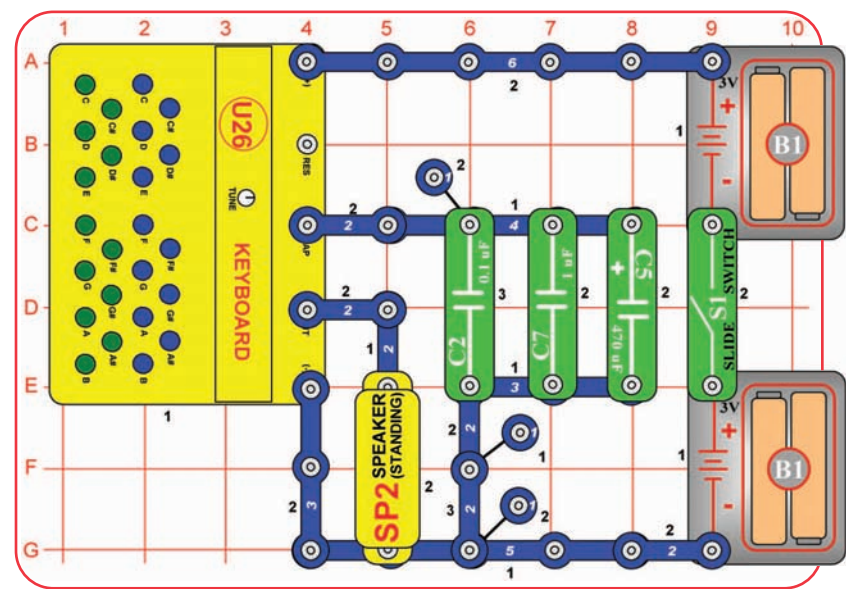

Turn on the right slide switch (S1). Press any green key and compare the sound when you remove one or two of the capacitors (C2, C5, and C7). You will only hear a click every few seconds if C5 is in the circuit.

Project 175

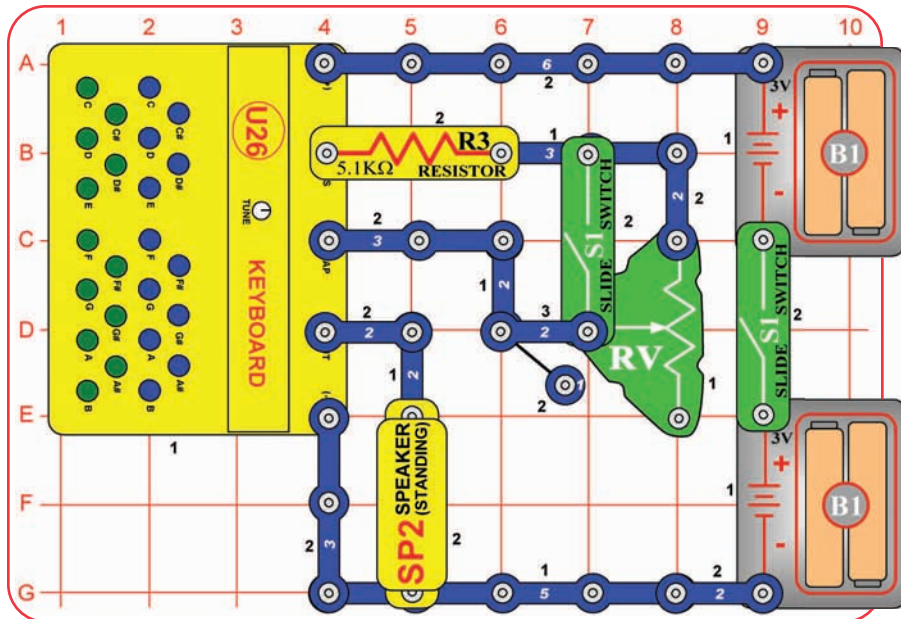

Resistors in Series

Inside the keyboard module (U26) is an oscillator circuit that produces separate tones for the blue and green keys. The frequency (pitch) of the tone is set using an internal resistor-capacitor network, with each key representing a different resistor value. The green keys can be adjusted using the tune knob.

The tone of the green keys can also be changed using external resistors and capacitors, which is done in many of the projects.

Turn on the right slide switch (S1). Set the lever on the adjustable resistor (RV) to each side and compare the sound with the left slide switch on or off.

With the lever up, RV is a 200W resistor. Turning the left switch off connects this in series with the 5.1k W resistor (R3), and has a small effect on the tone.

With the lever down, R V is a 50kW resistor. Turning the left switch of f connects this in series with the 5.1k W resistor (R3), and has a big effect on the tone.



Project 176

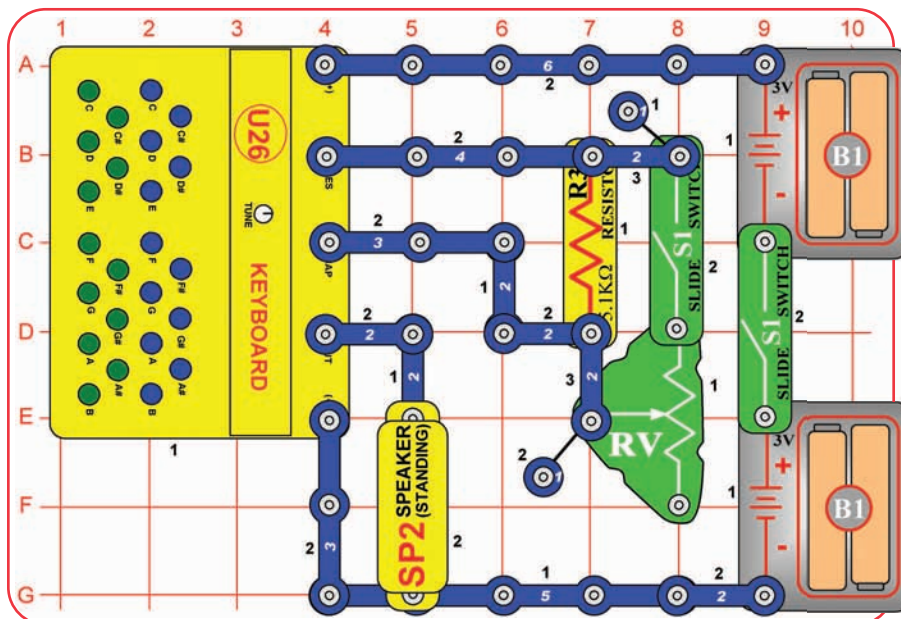

Resistors in Parallel

Think of resistors as obstructions to the flow of electricity. When there is only one path for electricity and part of it has a big obstruction, not much will flow. When there are several paths for electricity and one has a big obstruction, a lot will flow because most will flow through the unobstructed path.

Turn on the right slide switch (S1). Set the lever on the adjustable resistor (RV) to each side and compare the sound with the left slide switch on or off.

If there is no sound when the lever is set all the way up, adjust it down a little until there is sound.

With the lever up, RV is a 200 W resistor. Turning the left switch off connects this in parallel with the 5.1k W resistor (R3), and has a big effect on the tone.

With the lever down, RV is a 50kW resistor. Turning the left switch off connects this in parallel with the 5.1k W resistor (R3), and has a small effect on the tone.

Pressing any of the green keys now will change the tone, by connecting resistors inside the keyboard in parallel with your R3-RV resistor network.





Project 177

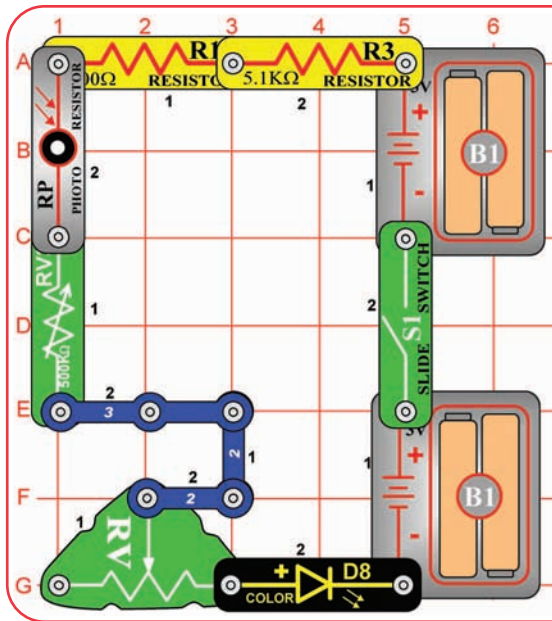

These five resistors are all connected in series, so the highest value, will have the most effect.

Swapping the locations of any parts in the circuit (without changing the direction of their "+" side) will not change how the circuit works. Try it.



Lots of Resistors in Series

Turn on the slide switch (S1). There are five resistors (R1, R3, RV, RV3, and RP), connected in series, that are controlling the current to the color LED (D8). See which resistor has the most effect on the LED brightness, by replacing them with a 3-snap wire or the red/black jumper wires, one at a time. The resistance of RV and RV3 depends on their setting, so try them at different settings. Note that the photoresistor's (RP's) resistance can be very high if there isn't bright light shining on it.



Project 178

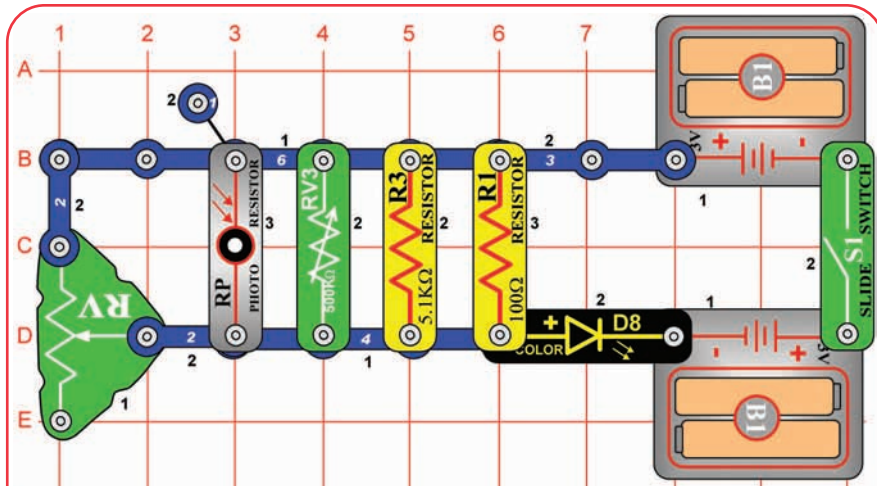

These five resistors are all connected in parallel, so the smallest one (R1, 100 W), will have the most effect.

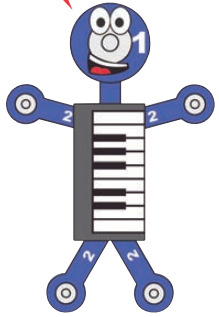

Lots of Resistors in Parallel

Turn on the right slide switch (S1). There are five resistors (R1, R3, RV, RV3, and RP), connected in parallel, that are controlling the current to the color LED (D8). See which resistor has the most effect on the LED brightness, by removing them one at a time. The resistance of RV and RV3 depends on their setting, so try them at different settings.



Project 179

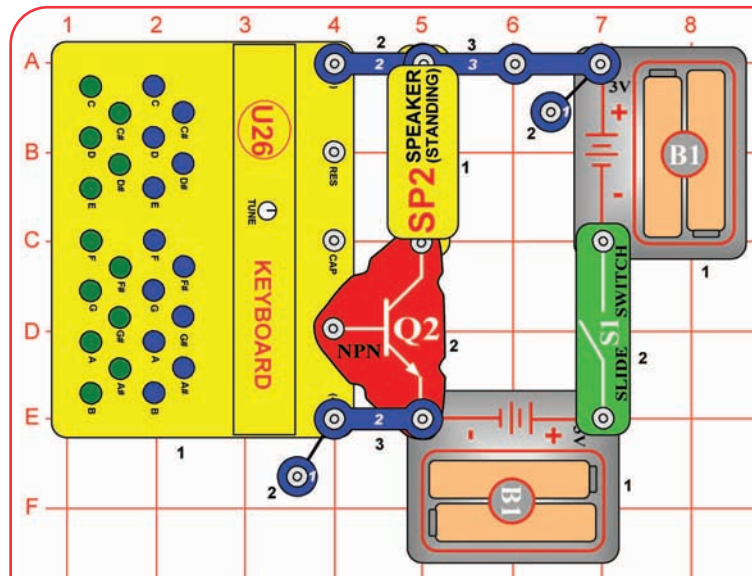

Let's play some more songs. Build the circuit shown here (it is similar to the project 1 circuit, but louder), and turn on the slide switch (S1).

For best song quality, align the blue and green keys together: Turn the TUNE knob while pressing the blue C key and the green C key at the same time. Slowly turn the knob across its entire range, and see how the sound varies. At most TUNE knob positions you will notice separate tones from the blue and green keys, but there will be a knob position where the blue and green tones blend together and seem like a single musical note - this is the best TUNE setting to play songs with. The blue and green keys are now aligned together.

To play a song, just press the key corresponding with the letter shown. If there is a "-" after a letter, press the key longer than usual.



Project 180 Be a Loud Musician (II)

Use the preceding circuit and songs, but press both the blue and green keys for each note, at the same time. Try this with the blue and green keys aligned (as per project 2), but also try them at different TUNE knob settings (so the keys are out of alignment).

Be a Loud Musician

It's Raining, It's Pouring:

A G E A G E G G E A G E E

It's rain-ing, it's pour-ing, Rain-y days aren't bor-ing. We

F F D D F F D D G F E D E C

like to jump, we like to splash, Let's hope it rains till mor-ning.

Jingle Bells

E E E E E E E G C D E-

Jin-gle bells, jin-gle bells, Jin-gle all the way,

F F F F F E E E E C G F D C-

Oh what fun it is to ride in a one horse o-pen sleigh.

London Bridge is Falling Down

G A G F E F G D E F E F G

Lon-don Bridge is fal-ling down, Fal-ling down, fal-ling down.

G A G F E F G D-G- E C-

Lon-don Bridge is fal-ling down, My fair la-dy.

If You're happy and You Know It

C C F F F F F F E F G-

If your're hap-py and you know it, clap your hands.

C C G G G G G G F G A-

If your're hap-py and you know it, clap your hands.

A A A# A# A# A# D D A# A# A A G F F-

If you're hap-py and you know it, And you real-ly want to show it,

A# A# G G G G F E C D E F-

If your're hap-py and you know it, clap your hands.

A Tisket, A Tasket

E G E F G E G C E A G E E

A tis-ket a tas-ket, A green and yel-low bas-ket

F F D D F F D D G F E D E C-

I wrote a let-ter to my love and on the way I dropped it.

Some songs have been modified to make them easier to play on your keyboard.

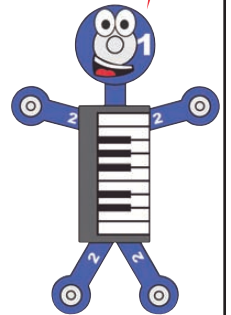



Project 181

Morse Code

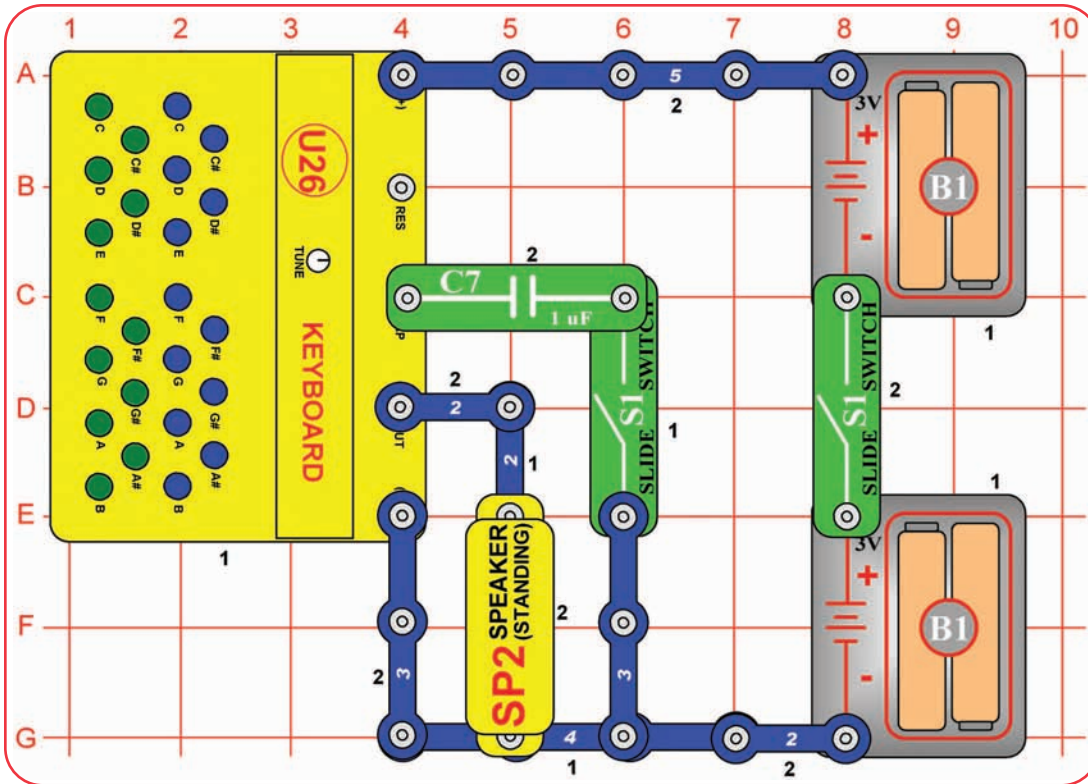

Build the circuit and turn on the right switch (S1). Press one key in a series of long and short bursts with pauses in between, and use Morse Code to send secret messages to your friends.

You can use the difference in pitch between keys to send messages to different people. For example, sending Morse Code with the blue C key can mean that the message is for one friend, using the green C key can mean it's for someone else, the green B key can be someone else. Turn on the left slide switch makes the pitch of the green keys much different, so can be used to identify messages for additional friends.

Morse Code: The forerunner of today's telephone system was the telegraph, which was widely used in the latter half of the 19th century. It only had two states - on or off (that is, transmitting or not transmitting), and could not send the range of frequencies contained in human voices or music. A code was developed to send information over long distances using this system and a sequence of dots and dashes (short or long transmit bursts). It was named Morse Code after its inventor. It was also used extensively in the early days of radio communications, though it isn't in wide use today. It is sometimes referred to in Hollywood movies, especially Westerns. Modern fiber optics communications systems send data across the country using similar coding systems, but at much higher speeds. Indian tribes sometimes used smoke signals to send messages.

MORSE CODE

A	· -	N	- ·	Period	- · - · -
B	- · · ·	O	- - -	Comma	- · - · -
C	- · - ·	P	- · - ·	Question	- · - · - ·
D	- · - ·	Q	- - - ·	1	- · - - -
E	- ·	R	- · · -	2	- · - - -
F	- · · -	S	- · · -	3	- · - · -
G	- · - ·	T	- · -	4	- · - · -
H	- · · ·	U	- · -	5	- · - · -
I	- · -	V	- · - ·	6	- · - · -
J	- · - -	W	- · - -	7	- · - · -
K	- · -	X	- · - -	8	- · - · -
L	- · - ·	Y	- · - -	9	- · - · -
M	- -	Z	- - ·	0	- - - -

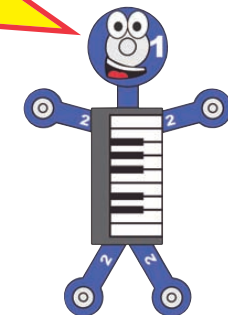

Project 182

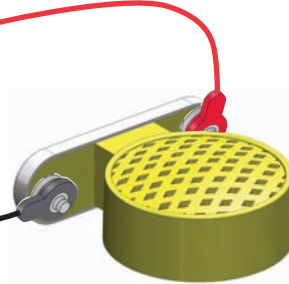
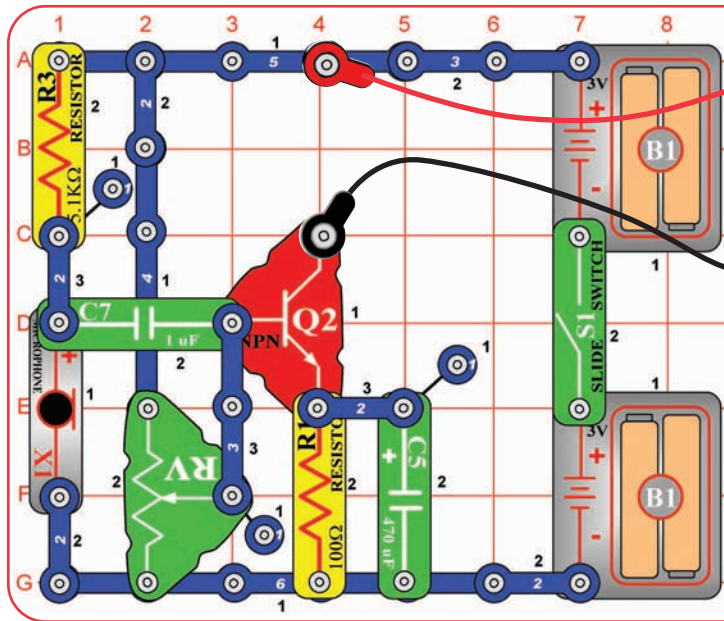

Transistor Audio Amplifier

Build the circuit with the speaker (SP2) connected using the red & black jumper wires. Set the adjustable resistor (RV) to mid-range, and turn on the slide switch (S1). Hold the speaker next to your ear and blow into the microphone (X1), or talk directly into it with your mouth close to it.

This circuit amplifies your voice and plays it on the speaker. It should be easy to hear the blowing, but it may be difficult to understand your voice, because there isn't enough amplification and there will be some distortion. Also, the sound from the speaker may not be as loud as hearing your voice directly.

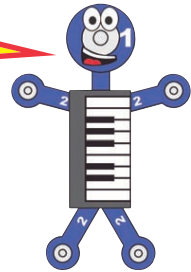

Project 183

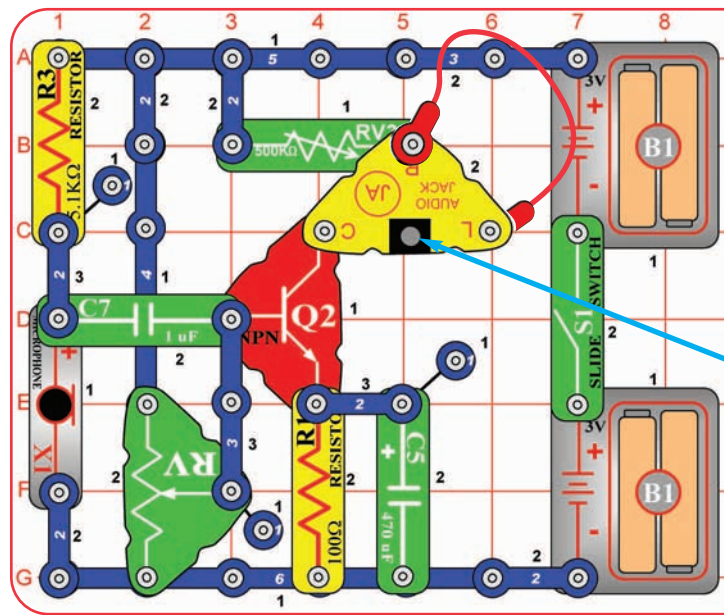

With headphones it may be easier to recognize the difference between the circuit sound and hearing your voice directly, than it had been with the speaker



Headphones (not included)

Transistor Audio Amplifier (II)

If you have headphones (not included), then modify the preceding circuit to match this one, and connect your headphones to the audio jack (JA). Set the adjustable resistor (RV) to mid-range, and set the 500kΩ adjustable resistor (RV3) for most comfortable sound level (turn to the left for higher volume, most of RV3's range will be very low volume). Turn on the slide switch (S1). Blow into the microphone (X1), or talk directly into it with your mouth close to it. The sound may not be very loud.

WARNING: Headphones performance varies, so use caution. Start with low volume, then carefully increase to a comfortable level. Permanent hearing loss may result from long-term exposure to sound at high volumes.



Project 184

Make Your Own Parts

Build the circuit and turn on the switch (S1). Initially set the lever on the adjustable resistor (RV) to the left, then move it later to vary the range of sounds that can be produced. Make your parts using either the water puddles method (A), the drawn parts method (B), or the pencil parts method (C). Touch the metal in the jumper wires to your parts and listen to the sound.

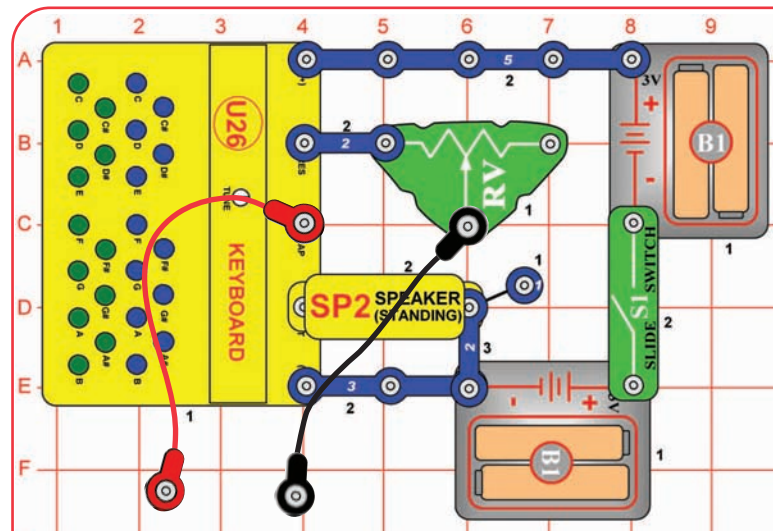

Method A (easy): Spread some water on the table into puddles of different shapes, perhaps like the ones shown here. Touch the jumper wires to points at the ends of the puddles. Small, narrow puddles may not produce any sound.



Method B (challenging): Use a SHARP pencil (No. 2 lead is best) and draw shapes, such as the ones here. Draw them on a hard, flat surface. Press hard and fill in several times until you have a thick, even layer of pencil lead. Touch the jumper wires to points at the ends of the drawings, then move them across the drawing to vary the sound. You may get better electrical contact if you wet the metal with a few drops of water. Wash your hands when finished.



Method C (adult supervision and permission required): Use some double-sided pencils if available, or VERY CAREFULLY break a pencil in half. Touch the jumper wires to the black core of the pencil at both ends.



Long, narrow shapes have more resistance than short, wide ones. The black core of pencils is graphite, the same material used in the resistors.

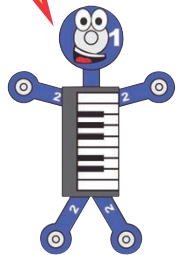

Next, place the loose ends of the jumper wires in a cup of water, make sure the metal parts aren't touching each other. The water should change the sound. The pitch may depend on the amount of water, so see if adding more water to the cup changes the sound.

Now add salt to the water and stir to dissolve it. The sound should have higher pitch now, since salt water has less resistance than plain water.

Don't drink any water used here.



Project 185 Color Touch Light

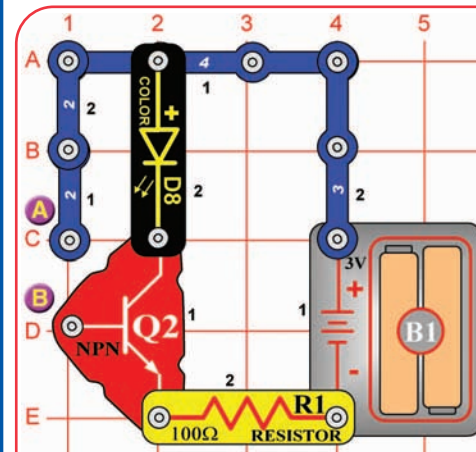

Build the circuit. It doesn't do anything, and may appear to be missing something. It is missing something, and that something is you.

Touch points A & B with your fingers. The color LED (D8) may be lit. If isn't, then you are not making a good enough electrical connection with the metal. Try pressing harder on the snaps, or wet your fingers with water or saliva. The LED should be on now. If it isn't very bright, then try going into a dimly lit room.

Project 186

Test Your Hearing

This project requires a smart phone with an internet connection, so you can download a free app. Find and download a “function generator” app that can generate sine and square signals. Visit the Snap Circuits® Sound product page at <http://www.elenco.com/downloads/scs185/> to find a few suggestions.

Set the app for “Sine” function (for a single tone), start it, and vary the frequency across the available range. You can listen to the sound directly or your smart phone, or use the circuit in project 60. Set the volume control on your smart phone (and using R V, if you are using project 60) so that the sound is at a comfortable level for middle frequencies.

See what range of frequency you can hear. Notice that the sound is loud at middle frequencies, but low (or no sound at all) at low or high frequency. There are two reasons for this:

1. Your hearing ability depends on frequency . Most people can hear frequencies in the range of 20 Hz to 20,000 Hz, but much better in the middle of this range than at the low or high ends of it. As you get older you don't hear higher frequencies as well, so use the same circuit to see what range of frequency your grandparents can hear.
2. Your speaker's ability to produce sound depends on frequency, and it may not perform as well at low or high frequency . Speakers are only designed to produce sound in the range that we can hear.

Part B: set the frequency on the function generator app to just below what you can hear, then change the function from “Sine” to “Square” function (for a tone with lots of overtones). You should be able to hear it now , because a signal with overtones has some energy at higher frequencies, which should be within your hearing range.

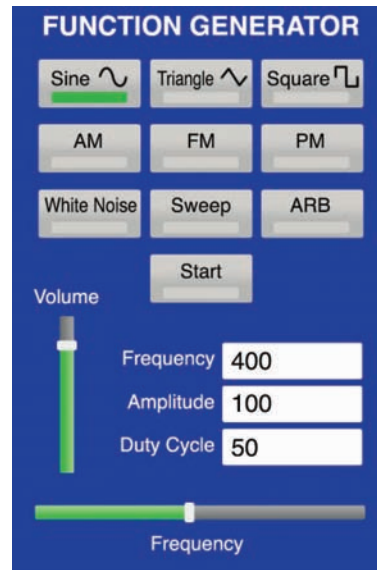

Project 187

See the Sound

This project requires a smart phone with an internet connection, so you can download a free app. Find and download an “oscilloscope” app that lets your smart phone act as an oscilloscope. Visit the Snap Circuits® Sound product page at <http://www.elenco.com/downloads/scs185/> to find a few suggestions.

An oscilloscope is an instrument that engineers use to actually look at electrical signals. Constant tones are especially interesting to look at, because they are repetitive and actually look like a wave.

Start the app and talk into the smart phone's microphone, and watch your voice on the screen. Try making a single tone at different frequencies, or whistling, or snapping your fingers.



Next, use the one of the keyboard (U26) circuits such as projects 1 or 25-26. Make sound with the keyboard and see what it looks like.

Try an echo circuit such as project 29, and see what an echo looks like.



Project 188

See the Spectrum

This project requires a smart phone with an internet connection, so you can download a free app. Find and download a “spectrum analyzer” app that lets your smart phone view the frequency spectrum of a signal. Visit the Snap Circuits® Sound product page at <http://www.elenco.com/downloads/scs185/> to find a few suggestions.

A spectrum analyzer is an instrument that engineers use to look at the frequency content of electrical signals, and shows which frequencies have the most energy. A pure tone will have all its energy at a single frequency while a tone with overtones will have the most energy at the main tone, but also have energy at multiples of the main tone. A complex sound will have its energy spread across many frequencies.

Spectrum analyzers usually show data as a chart of energy content versus frequency. Energy is usually shown in dB (decibels), a logarithmic measurement, so the strongest frequencies have much more energy than the weak ones shown. There is always a “noise floor” of background noise, which can make weak signals difficult to observe.

Start the app and talk into the smart phone’s microphone, and watch the frequency content of your voice on the screen. Try making a single tone at different frequencies, or whistling.

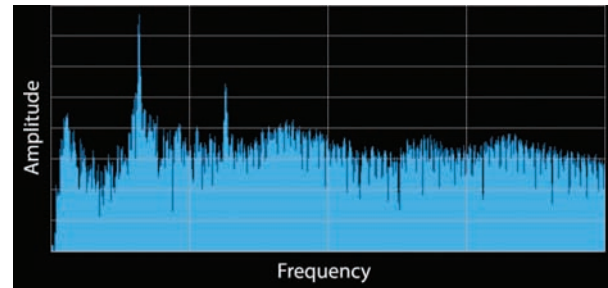
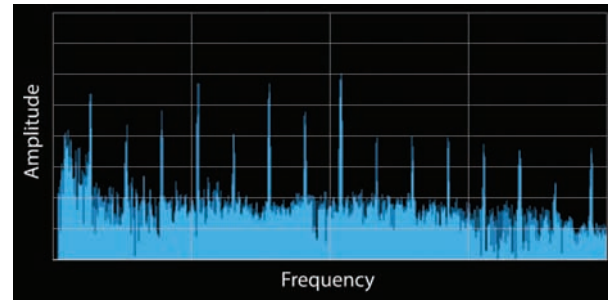

Next, use the one of the keyboard (U26) circuits such as projects 1, 6, or 25-26. Make sound with the keyboard and see what its frequency content looks like.

BONUS CIRCUIT FOR SNAP CIRCUITS® LIGHT OWNERS

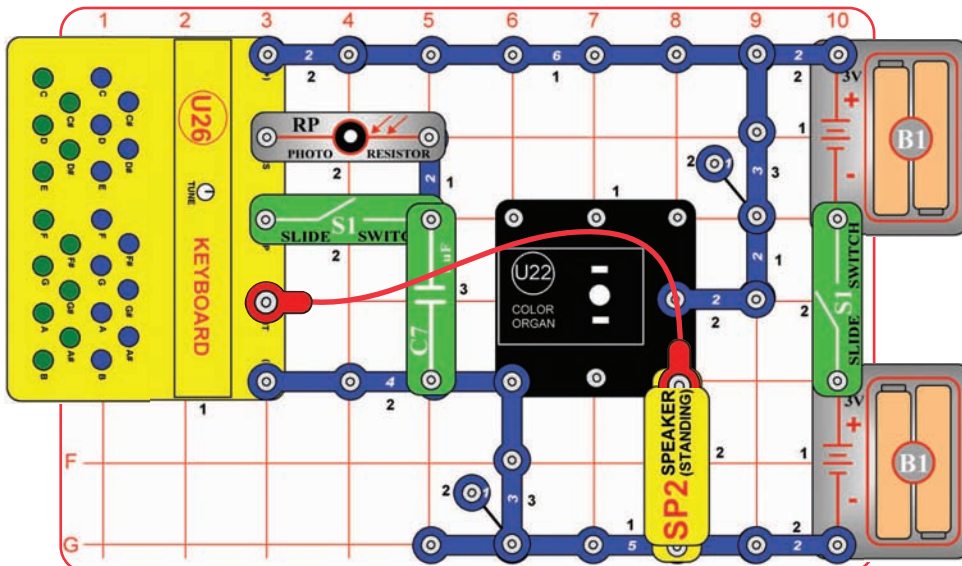

If you own Snap Circuits® LIGHT (Model SCL-175), then you may also build this circuit. Do not connect additional voltage sources from other sets, or you may damage your parts. Contact Elenco® if you have any questions.



Project #B1 See the Sound

This circuit uses the color organ module (U22) from the SCL-175 set. Build the circuit as shown, turn off the left slide switch (S1), and turn on the right slide switch. Press keys on the keyboard to make sounds and change the light on the color organ. Turn on the left slide switch to add optical control, and wave your hand over the photoresistor to also change the sound and light. If desired, add one of the SCL-175 LED attachments on the color organ.

SCS-185 SOUND Block Layout

Important: If any parts are missing or damaged, **DO NOT RETURN TO RETAILER.**

Call toll-free (800) 533-2441 or e-mail us at: help@elenco.com. Customer Service • 150 Carpenter Ave. Wheeling, IL 60090 U.S.A. **Note:** A complete parts list is on pages 2 and 3 in this manual.

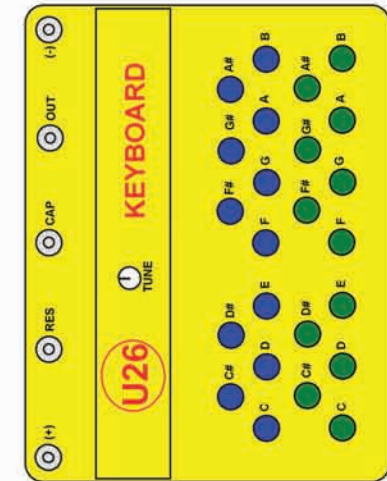
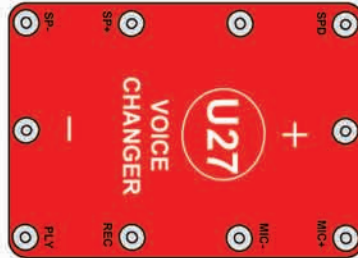

Base grid (11.0" x 7.7") overlays many parts

