

Engineer's Mini-Notebook

**Environmental
Projects**

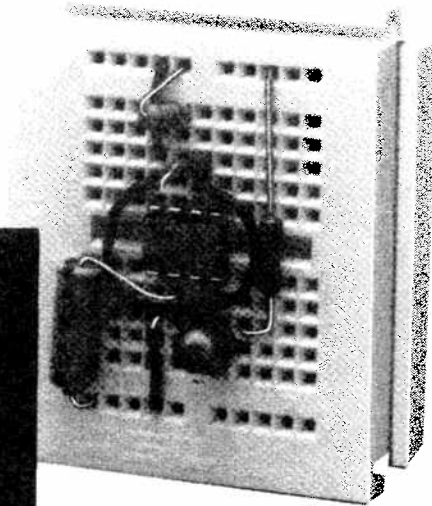
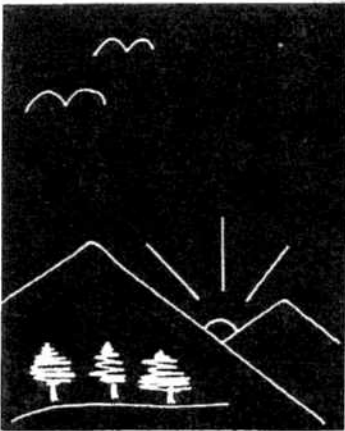

Forrest M. Mims III

ENGINEER'S
MINI-NOTEBOOK
ENVIRONMENTAL
PROJECTS

BY
FORREST M. MIMS III

FIRST PRINTING-1995

A SILICONCEPTS™ BOOK

COPYRIGHT © 1995 BY FORREST M. MIMS III
ALL RIGHTS RESERVED

PRINTED IN THE UNITED STATES OF AMERICA

THIS BOOK INCLUDES STANDARD APPLICATION CIRCUITS AND CIRCUITS DESIGNED BY THE AUTHOR. EACH CIRCUIT WAS ASSEMBLED AND TESTED BY THE AUTHOR AS THE BOOK WAS DEVELOPED. AFTER THE BOOK WAS COMPLETED, THE AUTHOR REASSEMBLED EACH CIRCUIT TO CHECK FOR ERRORS. WHILE REASONABLE CARE WAS EXERCISED IN THE PREPARATION OF THIS BOOK, VARIATIONS IN COMPONENT TOLERANCES AND CONSTRUCTION METHODS MAY CAUSE THE RESULTS YOU OBTAIN TO DIFFER FROM THOSE GIVEN HERE. THEREFORE THE AUTHOR AND RADIO SHACK ASSUME NO RESPONSIBILITY FOR THE SUITABILITY OF THIS BOOK'S CONTENTS FOR ANY APPLICATION. SINCE WE HAVE NO CONTROL OVER THE USE TO WHICH THE INFORMATION IN THIS BOOK IS PUT, WE ASSUME NO LIABILITY FOR ANY DAMAGES RESULTING FROM ITS USE. OF COURSE IT IS YOUR RESPONSIBILITY TO DETERMINE IF COMMERCIAL USE, SALE OR MANUFACTURE OF ANY DEVICE THAT INCORPORATES INFORMATION IN THIS BOOK INFRINGES ANY PATENTS, COPYRIGHTS OR OTHER RIGHTS.

DUE TO THE MANY INQUIRIES RECEIVED BY RADIO SHACK AND THE AUTHOR, IT IS NOT POSSIBLE TO PROVIDE PERSONAL RESPONSES TO REQUESTS FOR ADDITIONAL INFORMATION (CUSTOM CIRCUIT DESIGN, TECHNICAL ADVICE, TROUBLESHOOTING ADVICE, ETC.). IF YOU WISH TO LEARN MORE ABOUT ELECTRONICS, SEE OTHER BOOKS IN THIS SERIES AND RADIO SHACK'S "GETTING STARTED IN ELECTRONICS." ALSO, READ MAGAZINES LIKE POPULAR ELECTRONICS.

CONTENTS

UNITS OF MEASUREMENT	4
ENVIRONMENTAL SCIENCE	5
SAFETY	5
GRAPHING YOUR DATA	6-7
SOUND	8
SOUND INTENSITY	8
SOUND FREQUENCY	9
RANGE OF HUMAN HEARING	9
THE SPEED OF SOUND	9
MEASURING SOUND INTENSITY	10
TYPICAL SOUND LEVELS	11
ARTIFICIAL SOUND SOURCES	12
SOUND INTENSITY STUDIES	13
THE GREENHOUSE EFFECT	14
WATER VAPOR	15
RELATIVE HUMIDITY	15-17
THE HEAT ISLAND EFFECT	18-19
REMOTE TEMPERATURE TRANSMITTER	20
ABOVE-BELOW TEMPERATURE RECORDER	21
THE HYDROSPHERE	22-23
MEASURING RAIN DROPS	24
RAIN DROP DETECTOR	24
MEASURING RAIN FALL	25
NUMBER OF RAIN DROPS	25
DEW AND DEW POINT	26
PRECIPITABLE WATER	27
CLOUD HEIGHT	27
MEASURING CLOUDINESS	28
STUDYING LIGHTNING	29
WATER TURBIDITY	30
ELECTRONIC TURBIDIMETER	31
TESTING WATER	32
THE PH SCALE	32
WATER AND CARBON DIOXIDE	33
ACTIVATED CARBON AND WATER	33
	3

THE ATMOSPHERE

34-35

THE SOLAR RADIATION BUDGET

HAZE AND SOLAR RADIATION	36
ATMOSPHERIC OPTICAL THICKNESS	37
AIR MASS	38
LED SUN PHOTOMETER	38
SOLAR CELL RADIOMETER	39
SOLAR CELL SUN PHOTOMETER	40
HOW TO MEASURE THE SUN'S ANGLE	40
HOW TO MEASURE THE ET CONSTANT	41
TOTAL SKY SOLAR RADIOMETER	41
SHADOW BAND RADIOMETER	42
MEASURING TOTAL AND DIFFUSE LIGHT	43
MEASURING THE SOLAR AUREOLE	44
SUNSHINE DURATION RECORDER	45
PAPER SUNSHINE RECORDER	46
POP BOTTLE SUNSHINE RECORDER	46
ELECTRONIC SUNSHINE RECORDER	47
	48

UNITS OF MEASUREMENT

THE METRIC SYSTEM IS USED ALMOST EXCLUSIVELY IN SCIENCE. PRINCIPLE UNITS IN THIS BOOK:

INCHES TO MILLIMETERS	=	INCHES	x	25.4
MILLIMETERS TO INCHES	=	MILLIMETERS	x	0.03937
INCHES TO CENTIMETERS	=	INCHES	x	2.54
CENTIMETERS TO INCHES	=	CENTIMETERS	x	0.3937
FEET TO METERS	=	FEET	x	0.3048
METERS TO FEET	=	METERS	x	3.281
YARDS TO METERS	=	YARDS	x	0.9144
METERS TO YARDS	=	METERS	x	1.094
MILES TO KILOMETERS	=	MILES	x	1.609
KILOMETERS TO MILES	=	KILOMETERS	x	0.6214

TEMPERATURE - THE CELSIUS SCALE IS USUALLY USED IN SCIENCE. WATER FREEZES AT 0°C AND BOILS AT 100°C (SEA LEVEL). ROOM TEMPERATURE IS AROUND 23°C.

FAHRENHEIT TO CELSIUS = $(^{\circ}\text{F} - 32) \times 5/9$

CELSIUS TO FAHRENHEIT = $(^{\circ}\text{C} \times 9/5) + 32$

ENVIRONMENTAL SCIENCE

ENVIRONMENTAL SCIENCE IS ORGANIZED KNOWLEDGE ABOUT THE ENVIRONMENT BASED ON OBSERVATIONS, EXPERIMENTS AND ANALYTICAL STUDIES. THE NATURAL ENVIRONMENT CONSTANTLY CHANGES IN RESPONSE TO MANY INFLUENCES. FOR EXAMPLE:

- SUBTLE CHANGES IN THE SUN'S ENERGY MAY CAUSE MAJOR CLIMATE CHANGES ON EARTH.
- MAJOR VOLCANOES CAN EJECT SULFUR DIOXIDE (SO_2) INTO THE ATMOSPHERE. THE SO_2 COMBINES WITH WATER VAPOR TO FORM A MIST OF SULFURIC ACID (H_2SO_4) WHICH BLOCKS SUNLIGHT.
- INSECTS CAN DESTROY LARGE STANDS OF PLANTS AND EVEN TREES.
- A BEAVER DAM CAN CREATE A LARGE POND THAT ALTERS THE POPULATION OF PLANTS AND ANIMALS.
- EMISSIONS FROM COAL-FIRED POWER PLANTS CAN COMBINE WITH WATER VAPOR TO FORM THICK BLANKETS OF HAZE.

THE PROJECTS THAT FOLLOW DESCRIBE THE BASICS OF WATER TESTING AND MEASURING SOUND, HAZE, TEMPERATURE, SUNLIGHT AND LIGHTNING. BY REGULARLY MONITORING ONE OR MORE OF THESE OR OTHER PARAMETERS, YOU CAN MAKE AN IMPORTANT CONTRIBUTION TO ENVIRONMENTAL SCIENCE.

SAFETY

ALWAYS USE CAUTION WHEN MEASURING THE ENVIRONMENT, ESPECIALLY DURING LIGHTNING STORMS AND AROUND BODIES OF WATER. USE EAR PROTECTORS WHEN MEASURING LOUD SOUND. NEVER LOOK AT THE SUN WHEN MEASURING ITS LIGHT.

GRAPHING YOUR DATA

ONE OF THE BEST WAYS TO PRESENT YOUR DATA IS TO PLOT IT ON A GRAPH. THESE GRAPHS SHOW MY OBSERVATIONS AT GERONIMO CREEK, TEXAS.

LINE GRAPH

ALLOWS YOU TO SEE CHANGES IN TRENDS.

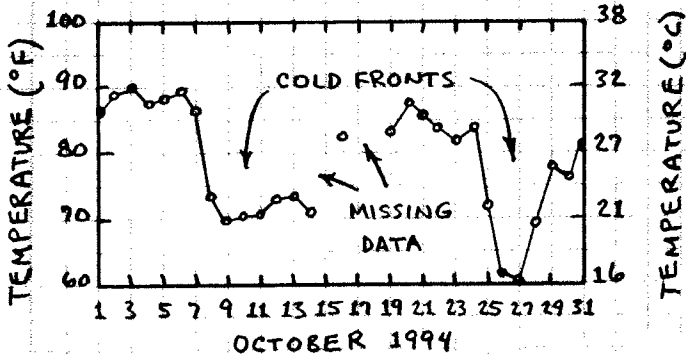

HISTOGRAM

A BARGRAPH THAT SHOWS THE FREQUENCY OF OCCURRENCE IS A HISTOGRAM. THIS ONE SHOWS THE CLASSIC BELL-SHAPED CURVE.

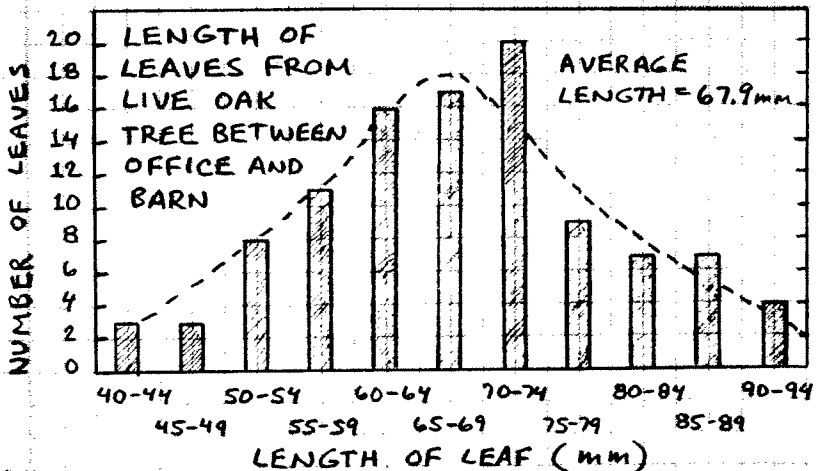

SCATTER GRAPH

IS THERE A RELATIONSHIP BETWEEN TWO SETS OF DATA? ASSIGN ONE SET TO X AXIS (\leftrightarrow) AND THE OTHER TO Y AXIS (\updownarrow). PLOT PAIRS OF DATA AS POINTS. THE MORE CLOSELY THE POINTS ARE CLUSTERED ALONG A LINE, THE BETTER THE CORRELATION OR AGREEMENT OF THE TWO SETS OF DATA.

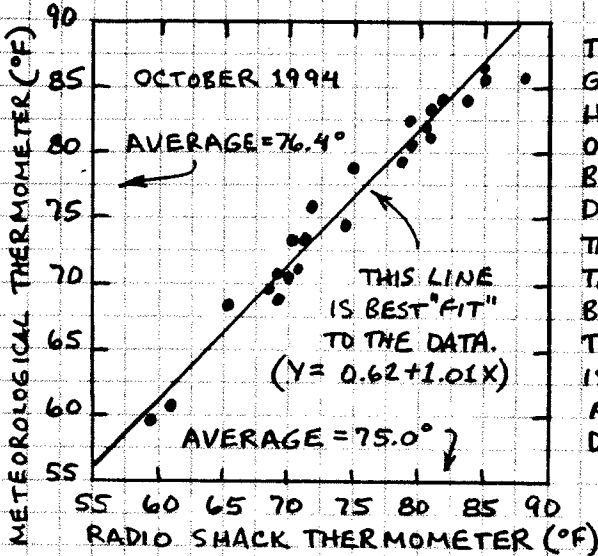

THIS SCATTER GRAPH SHOWS A HIGH DEGREE OF CORRELATION BETWEEN TWO DIGITAL THERMOMETERS. THE DIFFERENCE BETWEEN THE TWO AVERAGES IS THE "OFFSET," A CONSISTENT DIFFERENCE.

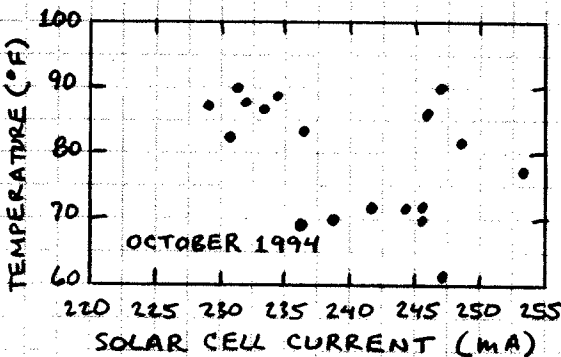

THIS SCATTER GRAPH SHOWS NO OBVIOUS CORRELATION BETWEEN TEMPERATURE AND INTENSITY OF SUN LIGHT.

GOING FURTHER

FOR SERIOUS ANALYSIS, USE A SCIENTIFIC CALCULATOR OR COMPUTER SPREADSHEET TO GRAPH YOUR DATA.

SOUND

WHEN YOU HEAR A SOUND, YOUR EARS ARE RESPONDING TO TINY, RAPID CHANGES IN THE PRESSURE OF THE AIR. THESE CHANGES ARE SOUND WAVES. THEY MAY HAVE A SINGLE PITCH (FREQUENCY) AND CONSTANT LOUDNESS (INTENSITY OR AMPLITUDE). OR THEY MAY BE A COMPLEX MIXTURE OF WAVES WITH DIFFERENT FREQUENCIES AND AMPLITUDES. REPETITIOUS WAVES OF UNIFORM OR GRADUALLY CHANGING FREQUENCY AND AMPLITUDE ARE USUALLY MORE PLEASANT THAN IRREGULAR, ABRUPTLY CHANGING WAVES.

SOUND INTENSITY

SINCE THE EAR RESPONDS TO AN ENORMOUS RANGE OF SOUND LEVELS, THE INTENSITY OF SOUND IS EXPRESSED USING A LOGARITHMIC SCALE IN WHICH 0 DECIBELS IS A BARELY PERCEPTIBLE SOUND WITH AN INTENSITY OF 10^{-12} WATTS PER SQUARE METER (W/m^2).

RATIO OF MEASURED
TO REFERENCE SOUND

RATIO IN
DECIBELS

	1	0 dB
	10	10 dB
	100	20 dB
	1,000	30 dB
	10,000	40 dB
	100,000	50 dB
	1,000,000	60 dB
	10,000,000	70 dB
	100,000,000	80 dB
	1,000,000,000	90 dB
	10,000,000,000	100 dB
	100,000,000,000	110 dB
	1,000,000,000,000	120 dB
	10,000,000,000,000	130 dB
	100,000,000,000,000	140 dB

SOUND FREQUENCY

SOUND WAVES RANGE FROM PURE SINE WAVES TO COMPLEX COMBINATIONS OF WAVES. THIS SINE WAVE HAS A FREQUENCY OF 1 CYCLE PER SECOND (1 HERTZ OR 1 Hz):

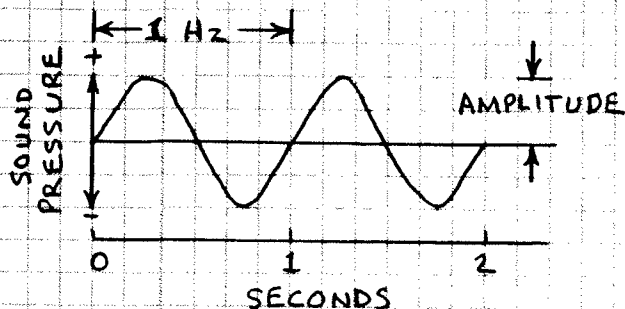

RANGE OF HUMAN HEARING

THE NORMAL HUMAN EAR CAN PERCEIVE SOUNDS RANGING IN FREQUENCY FROM 20 TO 20,000 Hz. THE PERCEPTION OF HIGH FREQUENCIES DECREASES WITH AGE AND IS REDUCED BY REPEATED EXPOSURE TO VERY LOUD SOUNDS. INFRASONIC SOUND IS SOUND HAVING A FREQUENCY BELOW THE RANGE OF HUMAN HEARING. ULTRASONIC SOUND IS SOUND HAVING A FREQUENCY ABOVE THE RANGE OF HUMAN HEARING.

THE SPEED OF SOUND

THE SPEED OF SOUND IN DRY AIR AT 0° CELSIUS (32° FAHRENHEIT) IS 331 METERS (1086 FEET) PER SECOND. THE SPEED INCREASES WITH TEMPERATURE. AT 20° C (68° F), THE SPEED OF SOUND IN AIR IS 343 METERS (1125 FEET) PER SECOND. SOUND WAVES TRAVEL THROUGH LIQUIDS AND SOLIDS MUCH MORE RAPIDLY THAN THROUGH AIR. THE SPEED OF SOUND IN WATER AT 25° C (77° F) IS 1497 METERS (4911 FEET) PER SECOND.

MEASURING SOUND INTENSITY

RADIO SHACK SOUND LEVEL METERS ARE IDEAL FOR CONDUCTING SOUND SURVEYS. WHEN MEASURING SOUND COMING FROM ONE DIRECTION, DO NOT HOLD THE METER BETWEEN YOUR BODY AND THE SOURCE OF THE SOUND. HOLD THE METER TO ONE SIDE AND POINT IT AT THE SOUND SOURCE. USE FAST RESPONSE FOR SPORADIC SOUNDS OR TO MEASURE PEAKS. USE SLOW RESPONSE TO MEASURE AVERAGE SOUND LEVEL.

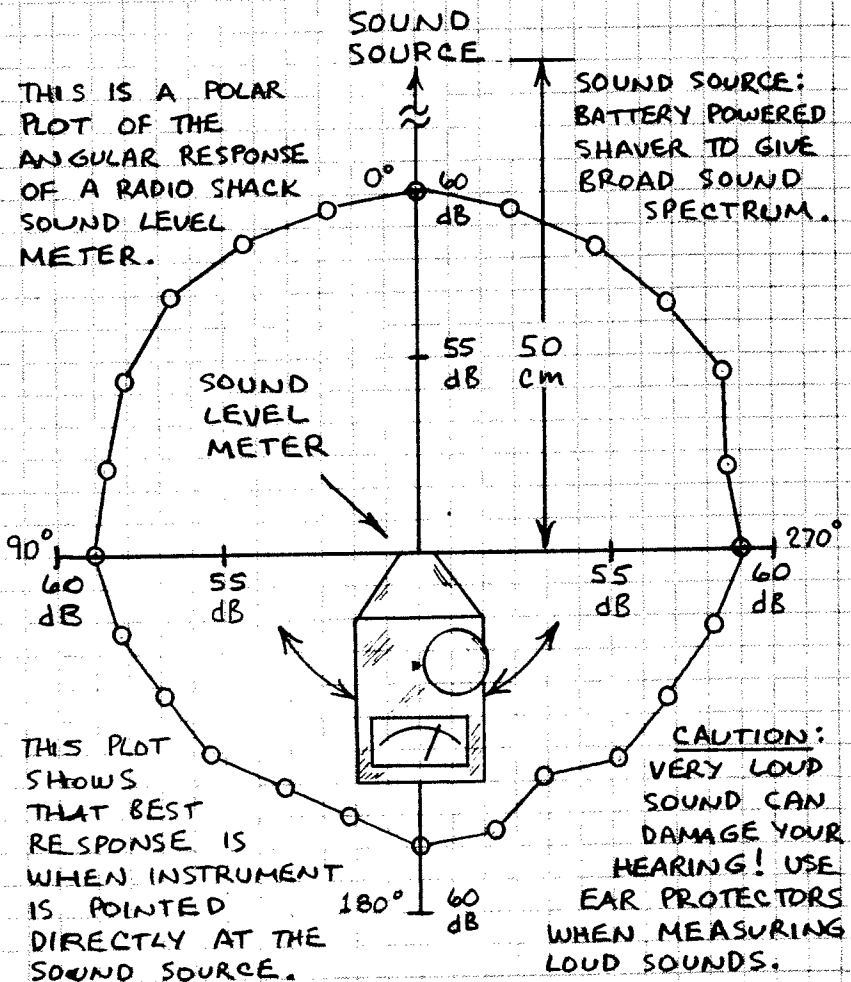

TYPICAL SOUND LEVELS

SOUND INTENSITY CAN VARY WITH WIND AND LOCATION OF THE SOUND LEVEL METER. HERE ARE SOME TYPICAL LEVELS:

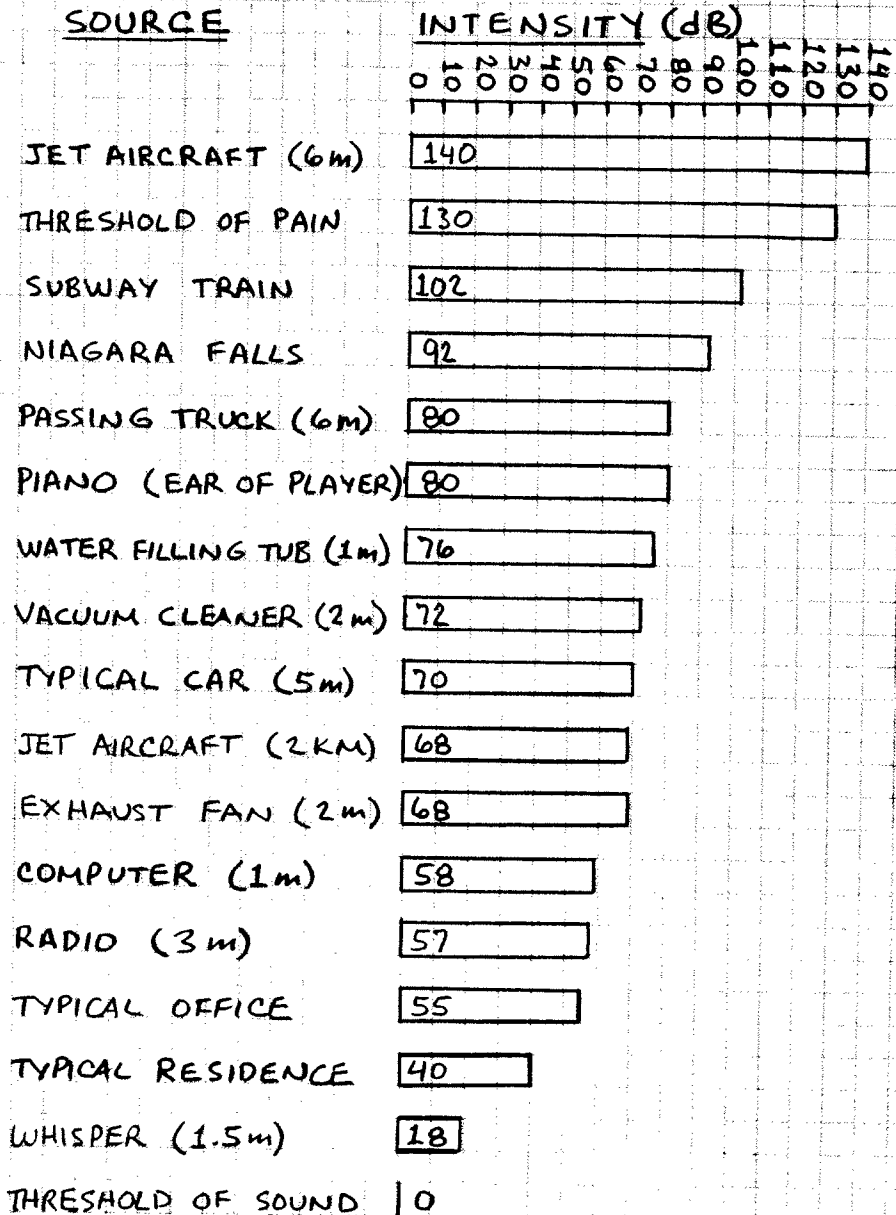

ARTIFICIAL SOUND SOURCES

ARTIFICIAL SOUND SOURCES CAN BE USEFUL IN EVALUATING THE ACOUSTICAL PROPERTIES OF A ROOM OR AUDITORIUM. THEY ARE ESPECIALLY USEFUL WHEN USED WITH A SOUND LEVEL METER. SMALL ELECTRIC MOTORS AND ELECTRIC SHAVERS CAN BE USED AS BROAD BAND, LOW FREQUENCY SOUND SOURCES. THE CIRCUITS BELOW ARE TONE SOURCES.

SINGLE FREQUENCY TONE

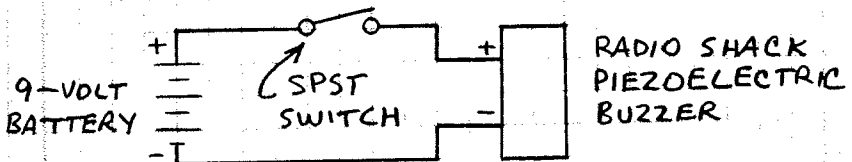

ADJUSTABLE FREQUENCY TONE

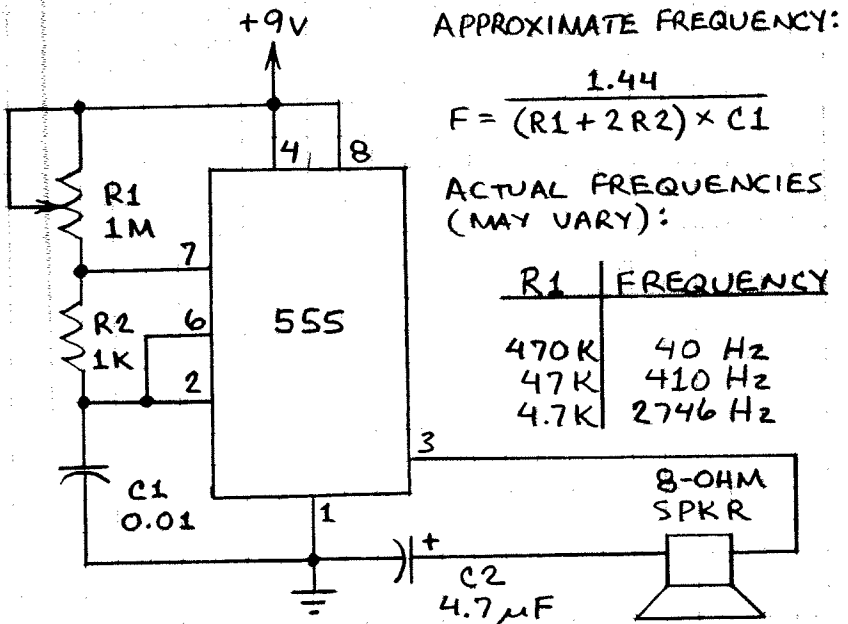

SOUND INTENSITY STUDIES

THE INTENSITY OF A SOUND IS INVERSELY PROPORTIONAL TO THE SQUARE OF THE DISTANCE TO THE SOURCE. THEREFORE A PLOT OF SOUND INTENSITY IN DECIBELS VS. DISTANCE TO THE SOURCE FORMS A STRAIGHT LINE.

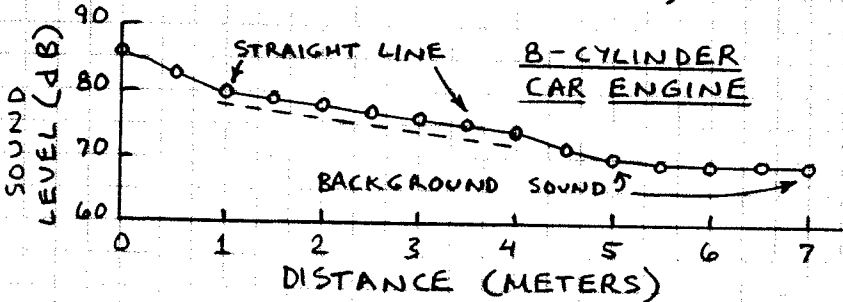
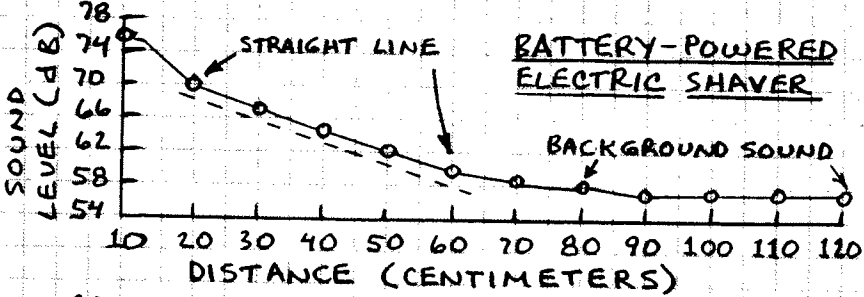
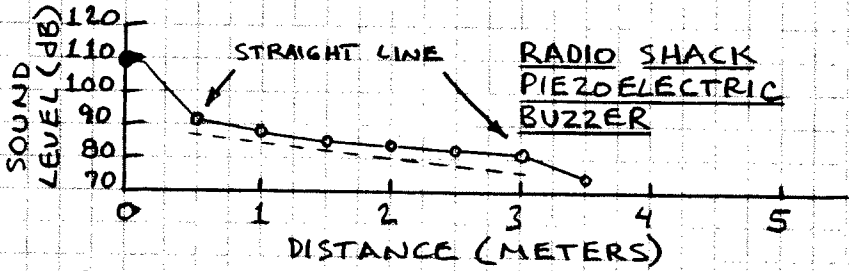

NOTE THAT STRAIGHT LINE BEGINS AWAY FROM SOURCE. TO ESTIMATE THE SOUND INTENSITY 10 METERS FROM A LOUD BUT DISTANT WATER FALL, JET, TRAIN, BAND, ETC., MAKE SEVERAL MEASUREMENTS AT DIFFERENT DISTANCES. PLOT THE DATA AND DRAW A LINE THROUGH THE POINTS. EXTEND THE LINE TO ESTIMATE THE INTENSITY OF THE SOUND NEARER ITS SOURCE.

THE GREENHOUSE EFFECT

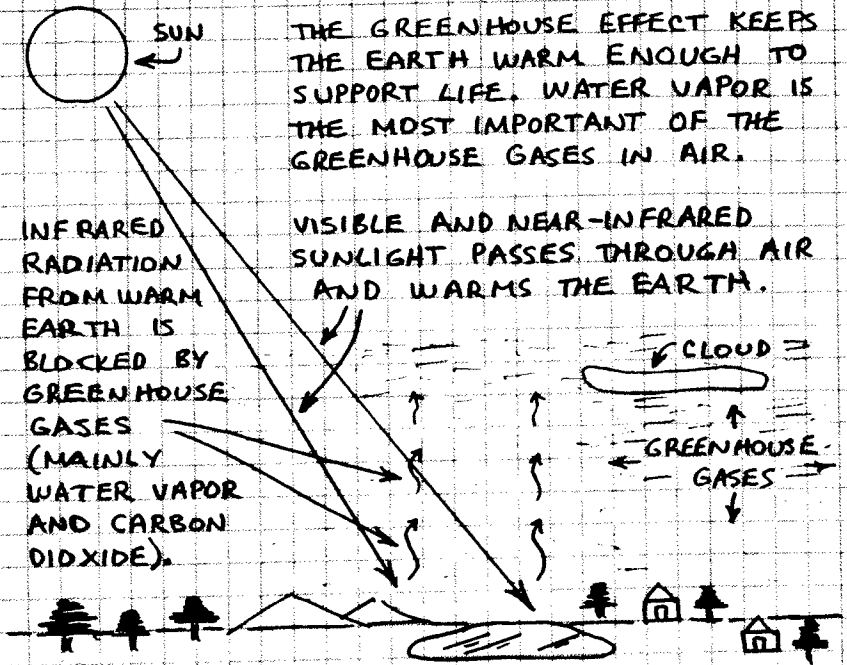

THE GREENHOUSE EFFECT KEEPS THE EARTH WARM ENOUGH TO SUPPORT LIFE. WATER VAPOR IS THE MOST IMPORTANT OF THE GREENHOUSE GASES IN AIR.

THE ROLE OF WATER VAPOR IN THE GREENHOUSE EFFECT IS OBVIOUS TO ANYONE WHO VISITS HUMID AND DESERT OR MOUNTAIN REGIONS. WATER VAPOR IN HUMID REGIONS TRAPS INFRARED FROM THE WARM EARTH, THUS KEEPING NIGHTS WARM. THE DRY AIR OF DESERTS AND MOUNTAINS PERMITS INFRARED FROM THE EARTH TO BE RADIATED INTO SPACE, THUS CAUSING COOL NIGHTS. CLOUDS ALSO PROVIDE A GREENHOUSE EFFECT. THIS PLOT OF TEMPERATURE AT MY TEXAS OFFICE SHOWS THE EFFECT OF WATER VAPOR AND CLOUDS:

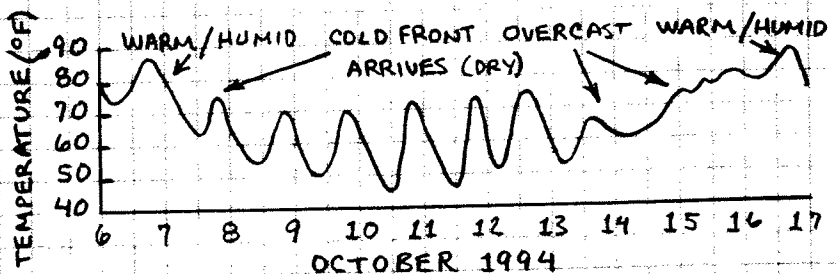

WATER VAPOR

THE ATMOSPHERE ALWAYS INCLUDES SOME WATER VAPOR. AIR IS NOT A CONTAINER FOR WATER; WATER MOLECULES ARE PART OF THE AIR. WATER VAPOR CAN BE UP TO 4% OF WARM, TROPICAL AIR. COLD AIR IS MUCH DRIER, AND AT -40°C (-40°F) THE MAXIMUM PERCENTAGE OF WATER IN AIR CANNOT BE GREATER THAN ABOUT 0.02%.

RELATIVE HUMIDITY

RELATIVE HUMIDITY IS THE RATIO OF THE ACTUAL TO THE MAXIMUM POSSIBLE WATER VAPOR IN THE AIR AT A GIVEN TEMPERATURE. SINCE THE MAXIMUM POSSIBLE WATER VAPOR IN WARM AIR IS MUCH HIGHER THAN THAT IN COLD AIR, RELATIVE HUMIDITY IS DEPENDENT ON TEMPERATURE. THUS THE RELATIVE HUMIDITY ON A COOL SPRING MORNING CAN BE 95% AND ONLY 50% LATER IN THE DAY, EVEN THOUGH THE TOTAL WATER VAPOR IN THE AIR HAS NOT CHANGED.

MEASURING RELATIVE HUMIDITY

USE A RELATIVE HUMIDITY METER.

OR USE TWO THERMOMETERS, ONE WITH A WET SENSOR OR BULB. BLOW AIR PAST THE WET SENSOR FOR A MINUTE. THEN USE CHART ON FOLLOWING TWO PAGES TO FIND RELATIVE HUMIDITY.

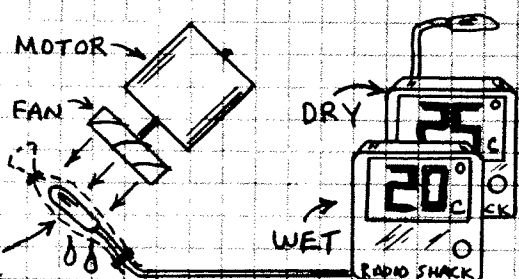
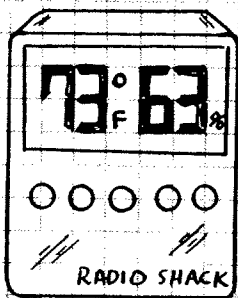

WET GAUZE, FABRIC OR HOLLOW SHOE LACE

RELATIVE HUMIDITY (%)

DRY BULB (°C) - WET BULB (°C)

	0.5	1.0	1.5	2.0	2.5	3.0
-5.0	88	77	66	54	43	32
-2.5	90	80	70	60	50	41
0.0	91	82	73	65	56	47
2.5	92	84	76	68	61	53
5.0	93	86	78	71	65	58
7.5	93	87	80	74	68	62
10.0	94	88	82	76	71	65
12.5	94	89	84	78	73	68
15.0	95	90	85	80	75	70
17.5	95	90	86	81	77	72
20.0	95	91	87	82	78	74
22.5	96	92	87	83	80	76
25.0	96	92	88	84	81	77
27.5	96	92	89	85	82	78
30.0	96	93	89	86	82	79
32.5	97	93	90	86	83	80
35.0	97	93	90	87	84	81
37.5	97	94	91	87	85	82
40.0	97	94	91	88	85	82

DRY BULB IS TEMPERATURE OF THE AIR.
WET BULB IS TEMPERATURE OF VENTILATED
 SENSOR WRAPPED IN MOIST CLOTH.

3.5	4.0	4.5	5.0	7.5	10.0	12.5	15.0	17.5
-----	-----	-----	-----	-----	------	------	------	------

21	11	0						
31	22	12	3					
39	31	23	15					
46	38	31	24					
51	45	38	32	1				
56	50	44	38	11				
60	54	49	44	19				
63	58	53	48	25	4			
66	61	57	52	31	12			
68	64	60	55	36	18	2		
70	66	62	58	40	24	8		
72	68	64	61	44	28	14	1	
73	70	66	63	47	32	19	7	
75	71	68	65	50	36	23	12	1
76	73	70	67	52	39	27	16	6
77	74	71	68	54	42	30	20	11
78	75	72	69	56	44	33	23	14
79	76	73	70	58	46	36	26	18
79	77	74	72	59	48	38	29	21

SOURCE:
 "METEOROLOGY" BY
 J. MORAN AND M. MORGAN,
 MACMILLAN PUBLISHING
 CO., p. 560 (1989).

TO CONVERT °C
 TO °FAHRENHEIT:

$$°F = (°C \times 9/5) + 32$$

EXAMPLE:
 DRY = 25°C
 WET = 20°C
 DRY - WET = 5°C
 RH = 63%

63

THE HEAT ISLAND EFFECT

TOWNS AND CITIES ARE SOMETIMES CALLED "HEAT ISLANDS" SINCE THEY ARE GENERALLY WARMER THAN THE NEARBY COUNTRYSIDE. YOU CAN EASILY MEASURE YOUR CITY'S HEAT ISLAND EFFECT WHILE DRIVING ACROSS TOWN. YOU WILL NEED:

- A NOTEBOOK OR TAPE RECORDER TO RECORD YOUR MEASUREMENTS.
- A THERMOMETER. (DIGITAL TYPE WITH SENSOR ON A CABLE WORKS BEST.)
- A FRIEND OR RELATIVE TO DRIVE WHILE YOU RECORD DATA. CAUTION: DO NOT ATTEMPT TO DRIVE AND RECORD DATA!

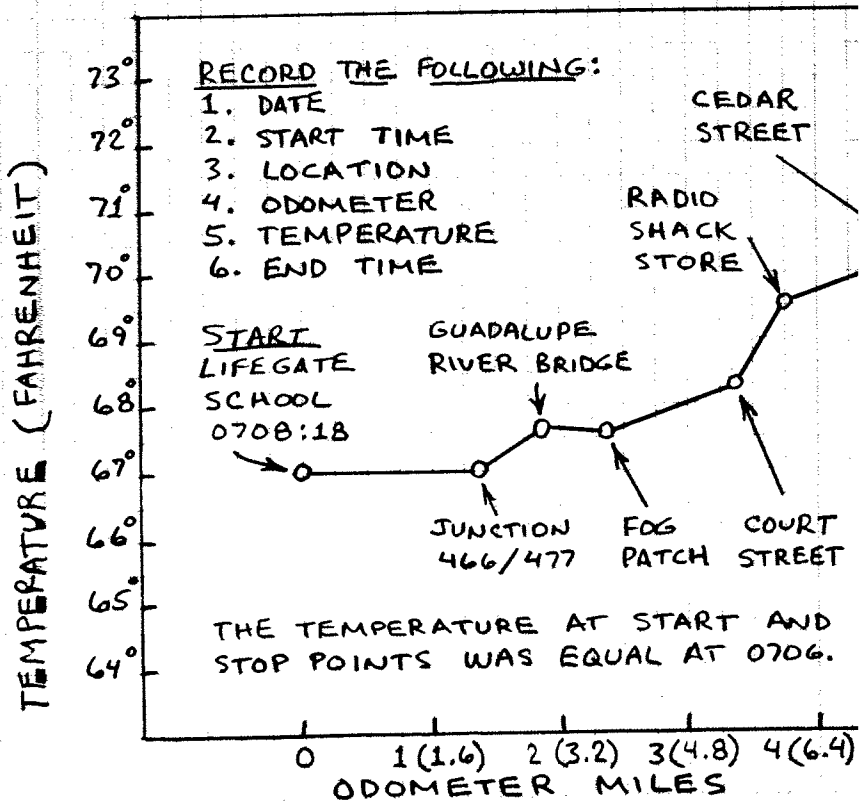

THE TEMPERATURE SENSOR MUST BE SHIELDED FROM SUNLIGHT AND KEPT AWAY FROM THE CAR'S ENGINE AND EXHAUST. MAKE HOLLOW TUBE FROM STIFF WHITE PAPER, TAPE TO SIDE MIRROR OR DOOR HANDLE WITH OPEN END FACING FORWARD. TAPE SENSOR INSIDE TUBE.

GOING FURTHER: MEASURE HEAT ISLAND EFFECT AT DIFFERENT TIMES OF DAY AND YEAR. IS THE EFFECT GREATER IN SUMMER OR WINTER? MORNING OR NIGHT? CAN YOU MEASURE THE HEAT ISLAND EFFECT OF LARGE PARKING LOTS HEATED BY THE SUN, FACTORIES, SUBDIVISIONS, ETC.?

GRAPH YOUR DATA - LIKE THIS ↴

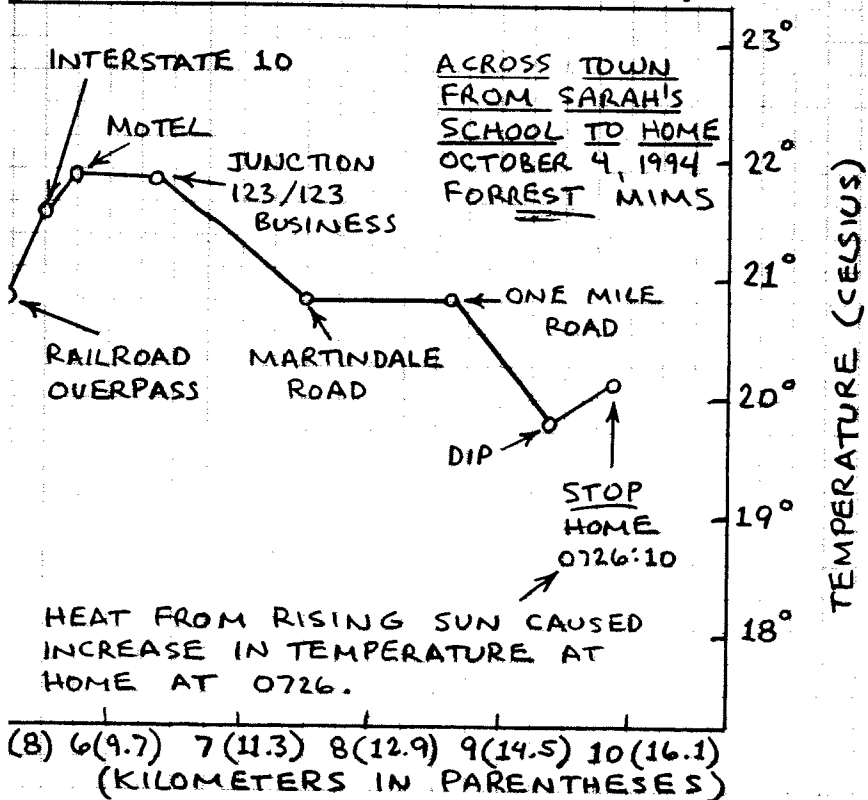

REMOTE TEMPERATURE TRANSMITTER

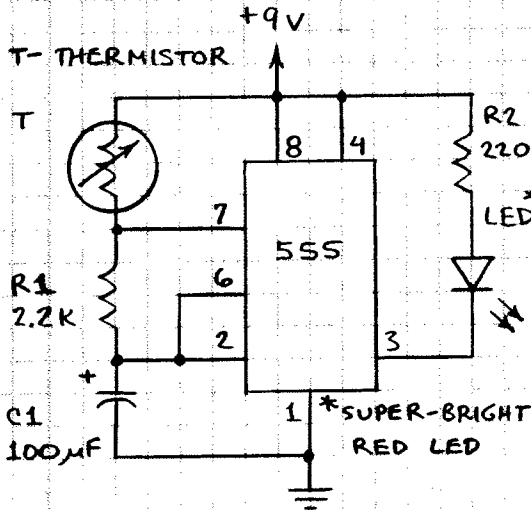

INSTALL THIS CIRCUIT IN A SMALL PLASTIC CASE. PLACE IN REMOTE SITE (TOP OF BUILDING, BRIDGE, HILL TOP, ETC.) AND POINT LED WHERE YOU PLAN TO BE. SECURE WITH TAPE OR BRACKET. CIRCUIT MUST BE IN SHADE.

THE LED EMITS FLASHES AT A RATE DETERMINED BY TEMPERATURE. FLASHES FROM A SUPER-BRIGHT LED CAN BE SEEN OVER A CONSIDERABLE RANGE, EVEN IN DAYLIGHT. USE BINOCULARS OR TELESCOPE TO INCREASE RANGE. TO CALIBRATE, INSULATE LEADS OF THERMISTOR WITH SILICONE SEALANT AND DIP IN ICE WATER. COUNT FLASHES IN 15 SECONDS AND READ WATER TEMPERATURE FROM THERMOMETER. ADD WARM WATER AND REPEAT THE MEASUREMENT PROCEDURE 5 OR MORE TIMES. PLOT DATA LIKE THIS:

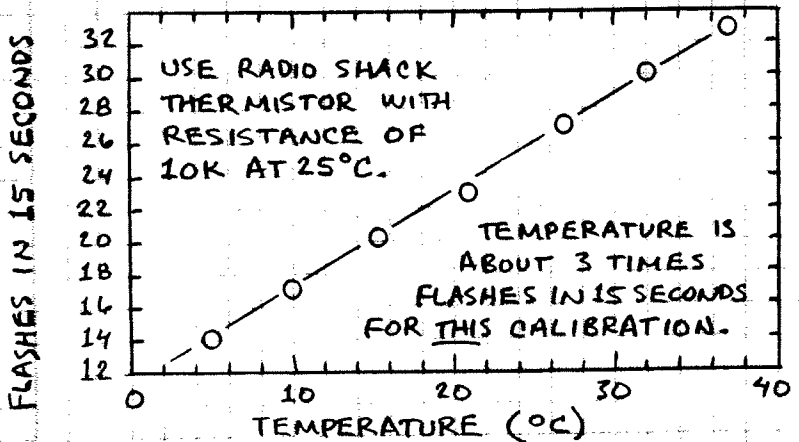

ABOVE-BELOW TEMPERATURE RECORDER

SOME FRUIT TREES REQUIRE A MINIMUM NUMBER OF HOURS WHEN THE TEMPERATURE IS BELOW FREEZING. THIS CIRCUIT RECORDS THE TIME THE TEMPERATURE IS BELOW 0°C (32°F) OR ANOTHER TEMPERATURE SELECTED BY R_2 .

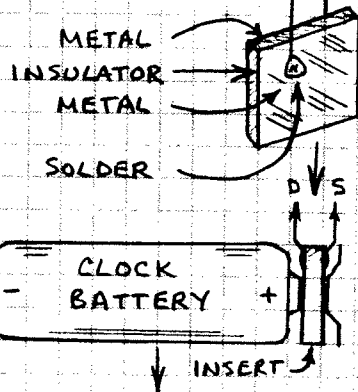
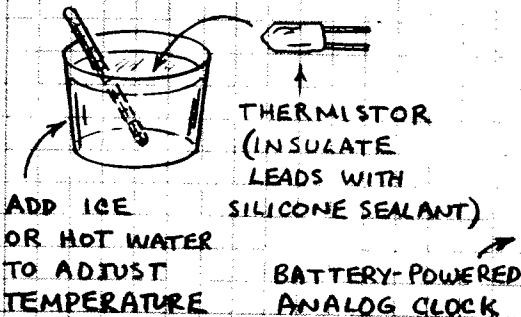
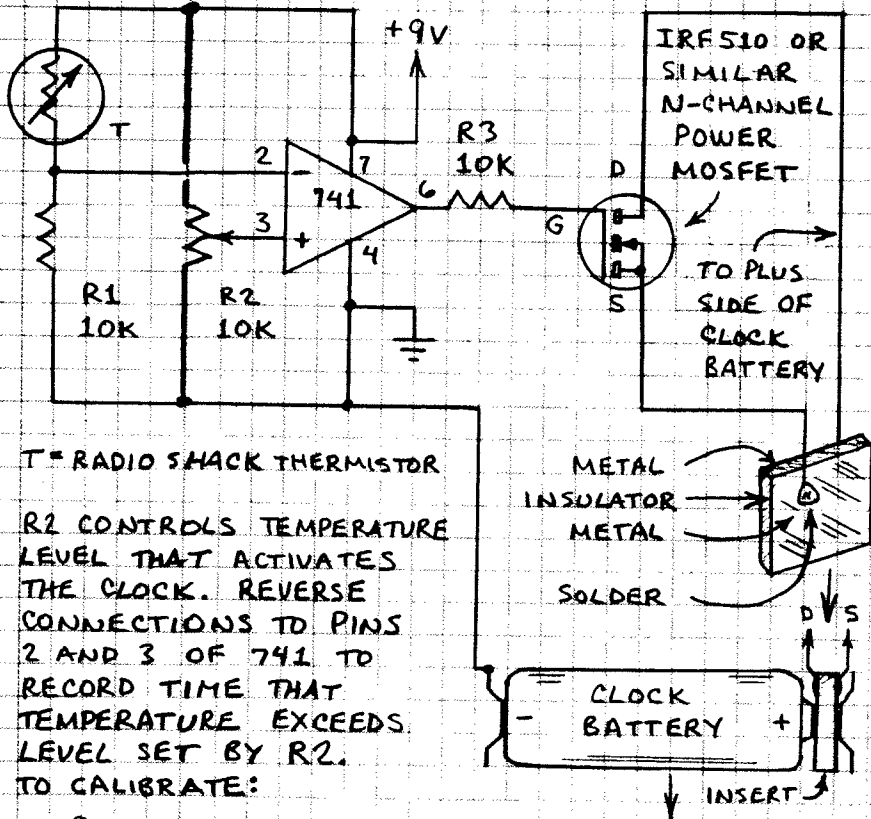

THE HYDROSPHERE

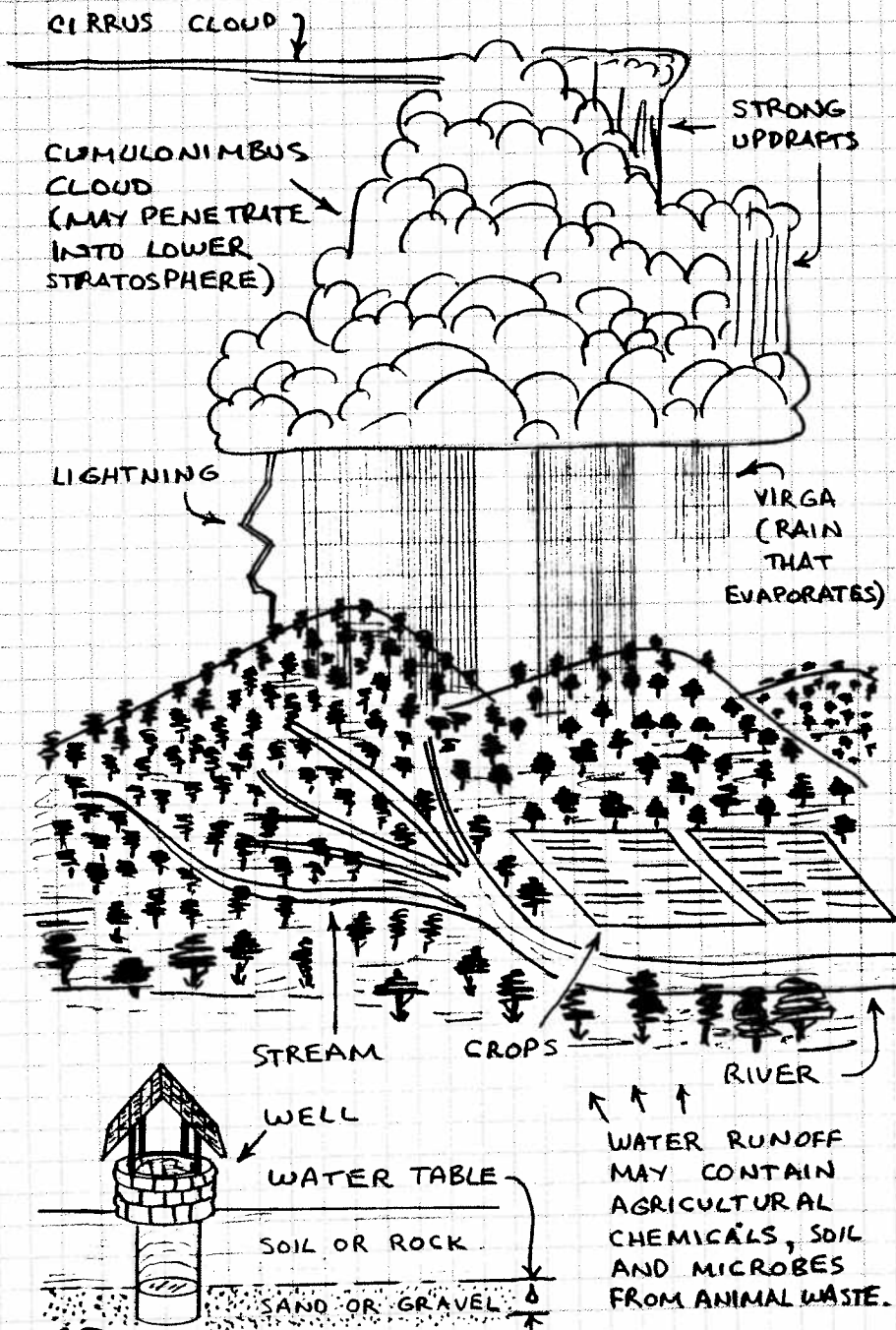

TINY CLOUD DROPLETS FORM WHEN WATER VAPOUR CONDENSES ON TINY PARTICLES OF DUST, SALT, ETC. ALWAYS PRESENT IN THE AIR.

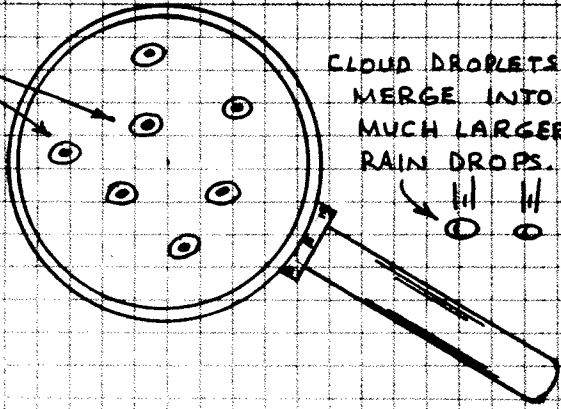

CLOUD DROPLETS MERGE INTO MUCH LARGER RAIN DROPS.

FAIR WEATHER CUMULUS CLOUDS

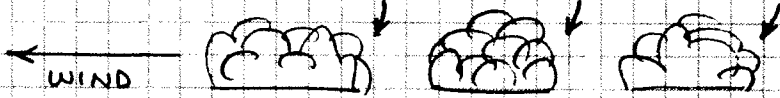

WATER VAPOUR FROM PLANTS AND EVAPORATED FROM BODIES OF WATER

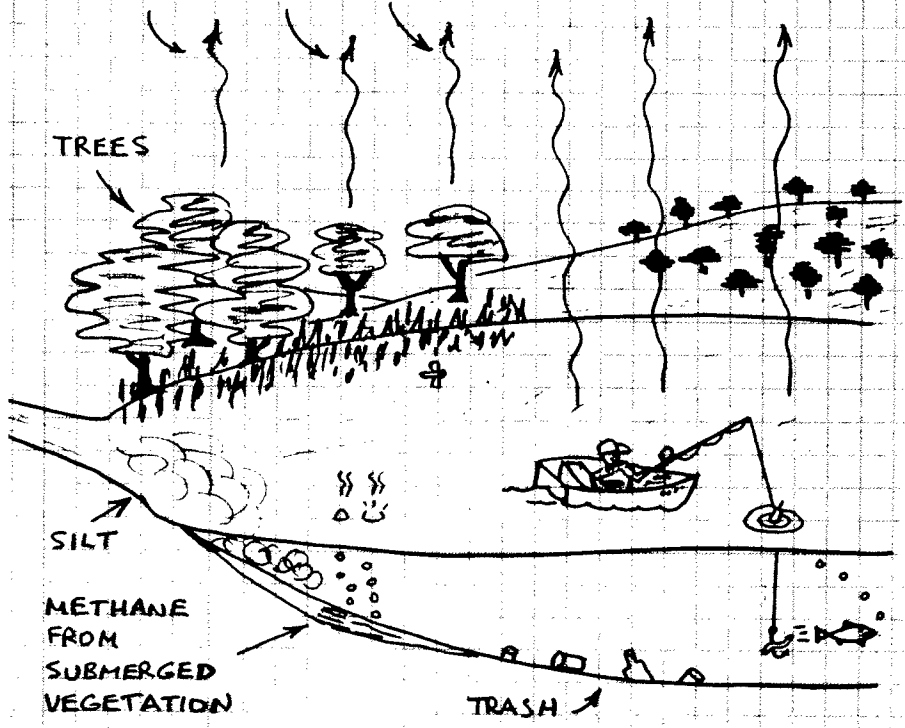

MEASURING RAIN DROPS

A TYPICAL RAIN DROP HAS A DIAMETER OF ABOUT 2 MILLIMETERS (0). DROPS CAN BE SMALLER OR LARGER. USE THIS INSTRUMENT TO STUDY THE SIZE OF RAIN DROPS:

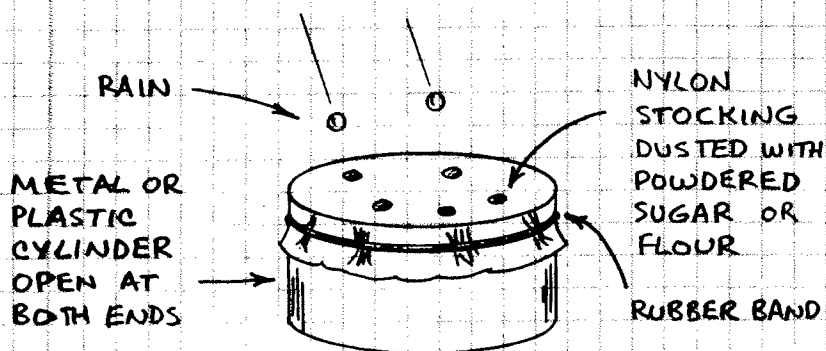

MEASURE AND RECORD DIAMETER OF INDIVIDUAL DROPS AND AVERAGE DIAMETER OF ALL DROPS.

RAIN DROP DETECTOR

THIS SIMPLE CIRCUIT WILL SOUND A TONE WHEN A RAIN DROP SPLASHES ON A SENSOR. THE SENSOR CAN BE ALUMINUM SCREEN MOUNTED JUST ABOVE A METAL PLATE (C.G. COPPER FOIL ON PC BOARD). OR MAKE A "COMB" SENSOR:

ETCHED CIRCUIT "COMB"

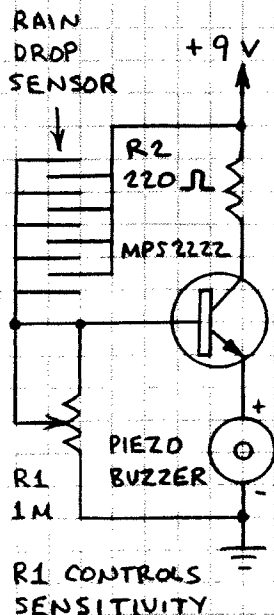
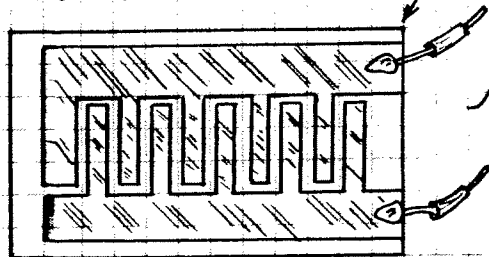

MEASURING RAIN FALL

MEASURING THE AMOUNT OF RAIN AND SNOW IS AN IMPORTANT PART OF ENVIRONMENTAL MONITORING.

USE STORE-BUGHT RAIN GAUGE OR MAKE YOUR OWN USING A CLEAR PLASTIC CYLINDER WITH A FLAT BOTTOM. PLACE GAUGE AWAY FROM TREES AND BUILDINGS. NOTE: WIND MAY REDUCE THE RAIN COLLECTED BY THE GAUGE BY UP TO 10%.

ADD A FUNNEL TO INCREASE ACCURACY WHEN MEASURING SMALL AMOUNTS OF RAIN. DIVIDE AREA OF LARGE END OF FUNNEL BY AREA OF INSIDE, OPEN END OF GAUGE TO GET CORRECTION FACTOR. DIVIDE HEIGHT OF WATER IN GAUGE BY CORRECTION FACTOR TO GET ACTUAL RAIN FALL.

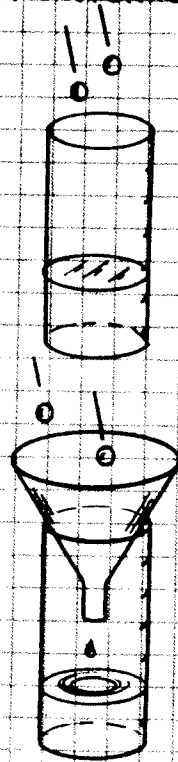

NUMBER OF RAIN DROPS

THE VOLUME OF A SPHERICAL RAIN DROP WITH A DIAMETER OF 2.5mm IS 8.18 mm^3 ($V = \frac{4}{3} \pi r^3$).

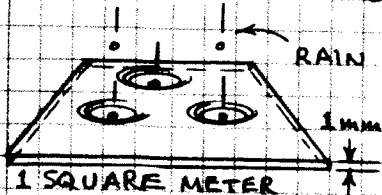

VOLUME OF 1 SQUARE METER OF RAIN 1mm DEEP IS $1,000,000 \text{ mm}^3$. THIS EQUALS 122,249 2.5mm DROPS.

122,249 DROPS PER MILLIMETER OF RAIN PER SQUARE METER IS 122,249,000,000 DROPS PER SQUARE KILOMETER OR 316,623,456,459 DROPS PER SQUARE MILE!

DEW

DEW IS LIQUID WATER THAT CONDENSES ON COOL OBJECTS. UP TO 0.6 MM (0.02 INCH) OF DEW MAY CONDENSE ON EXPOSED OBJECTS AND PLANTS AT NIGHT.

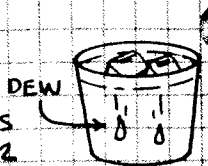

DEW POINT

THE TEMPERATURE AT WHICH DEW BEGINS TO FORM IS THE DEW POINT. THE DEW POINT REVEALS MUCH ABOUT THE LOCAL WEATHER:

1. THE TEMPERATURE AT NIGHT USUALLY DOES NOT FALL BELOW THE DEW POINT.
2. A DEW POINT OF 20°C (68°F) OR HIGHER AND AN APPROACHING COLD FRONT MEANS THUNDERSTORMS ARE POSSIBLE.
3. EXPECT FOG IF THE PREDICTED LOW TEMPERATURE MATCHES THE DEW POINT.
4. A DEW POINT OF 20°C (68°F) OR HIGHER MEANS THE AIR IS UNCOMFORTABLY HUMID.
5. WHEN THE DEW POINT IS BELOW FREEZING, FROST MAY FORM ON EXPOSED SURFACES.
6. DEW THAT FREEZES FORMS A GLAZE OF ICE.

MEASURING DEW POINT

IF YOU MAKE A WET/DRY RELATIVE HUMIDITY INSTRUMENT (HYGROMETER, SEE P.15), THE DEW POINT IS APPROXIMATELY:

$$D.P. = (5T_{\text{WET}} - 2T_{\text{DRY}}) / 3 \quad (^\circ\text{CELSIUS})$$

T IS TEMPERATURE. FORMULA FROM "CLIMATE DATA AND RESOURCES" BY E. LINACRE (ROUTLEDGE, 1992).

PRECIPITABLE WATER

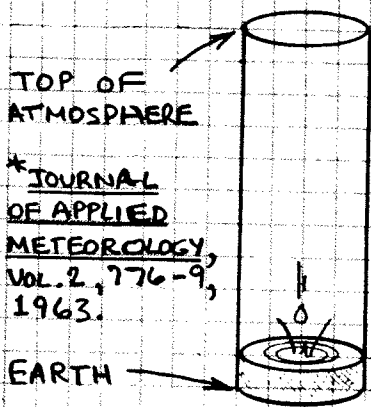

* JOURNAL
OF APPLIED
METEOROLOGY,
VOL. 2, 776-9,
1963.

CONDENSING THE WATER VAPOR IN A COLUMN THROUGH THE ATMOSPHERE YIELDS THE PRECIPITABLE WATER. C.H. REITAN* HAS DEVISED A FORMULA THAT ESTIMATES THE PRECIPITABLE WATER:

$$\ln W = (0.061 \times D.P.) - 0.11$$

$\ln W$ IS NATURAL LOG OF PRECIPITABLE WATER (CM).
D.P. IS DEW POINT ($^{\circ}C$).

CLOUD HEIGHT

CUMULUS CLOUDS FORM WHEN WARM, HUMID AIR RISES TO WHERE THE AIR TEMPERATURE FALLS BELOW THE DEW POINT. KNOWING THAT AIR TEMPERATURE FALLS ABOUT $2.77^{\circ}C$ ($5.5^{\circ}F$) PER 0.3 KILOMETER (1,000 FEET), LESLIE TROWBRIDGE* DERIVED THIS FORMULA FOR ESTIMATING THE HEIGHT OF THE BASE OF A CUMULUS CLOUD:

$$\text{HEIGHT (FEET)} = 227 \times (T - D.P.)$$

T = GROUND TEMPERATURE ($^{\circ}F$)

D.P. = DEW POINT ($^{\circ}F$)

DESCENDING, COOL AIR



SUNLIGHT WARMS THE EARTH. COLUMNS OF WARM, MOIST AIR THEN RISE IN THE SKY.



* "EXPERIMENTS IN METEOROLOGY," DOUBLEDAY, P. 239, 1974.

MEASURING CLOUDINESS

THE TEMPERATURE OF EARTH IS REGULATED IN PART BY CLOUDS. WARM AIR CAN CONTAIN MORE WATER VAPOR, HENCE MORE CLOUDS. THE CLOUDS REFLECT SUN LIGHT BACK INTO SPACE, THUS COOLING THE EARTH. RECORDING THE FRACTION OF THE SKY COVERED BY CLOUDS CAN PROVIDE IMPORTANT INFORMATION ABOUT THE EFFECT OF CLOUDS ON CLIMATE. THE FRACTION OF SKY COVERED BY CLOUDS IS MEASURED IN TENTHS OR OCTAS (EIGHTHS):

0 TENTHS OR 0 OCTAS = CLOUD-FREE SKY
5 TENTHS OR 4 OCTAS = 50% CLOUDINESS
10 TENTHS OR 8 OCTAS = OVERCAST SKY

ESTIMATE CLOUDINESS IN EACH QUADRANT OF THE COMPASS. AVERAGE THE 4 ESTIMATES TO GET THE OVERALL CLOUDINESS.

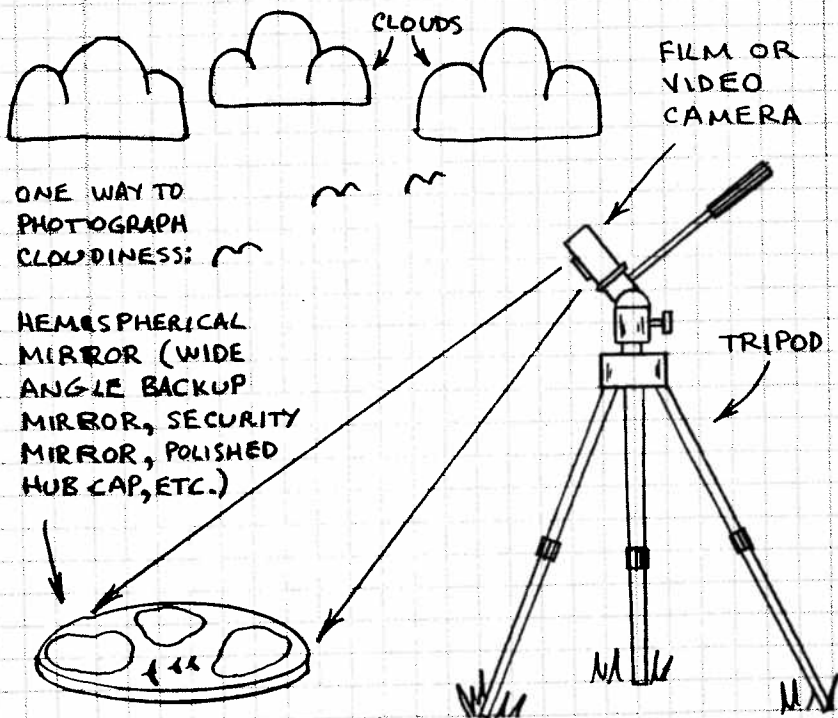

STUDYING LIGHTNING

THE AIR IN THE PATH OF A LIGHTNING BOLT IS HEATED ALMOST INSTANTLY TO $30,000^{\circ}\text{C}$ ($54,000^{\circ}\text{F}$). THE PRESSURE OF THIS AIR CAN BE 10 TO 100 TIMES THE PRESSURE AT SEA LEVEL. THE RESULTING SHOCK WAVES CAUSES THE SOUND HEARD AS THUNDER.

YOU CAN USE A DIGITAL STOP WATCH TO MEASURE DISTANCE BETWEEN YOU AND A LIGHTNING BOLT AND TO ESTIMATE THE TOTAL LENGTH OF LIGHTNING BOLTS.

DISTANCE TO BOLT:
START STOPWATCH WHEN YOU SEE FLASH AND STOP WHEN YOU HEAR THUNDER. DISTANCE IS ELAPSED SECONDS TIMES 1125 (FEET) OR 343 (METERS).

LENGTH OF BOLT:
START STOPWATCH WHEN YOU FIRST HEAR THUNDER AND STOP WHEN THUNDER ENDS. MINIMUM LENGTH OF THE BOLT IS ELAPSED SECONDS TIMES 1.86 (MILES) OR 3 (KILOMETERS). SEE "THUNDER" BY A. FEW, SCIENTIFIC AMERICAN, JULY 1975.

LIGHTNING STRUCK ELM TREE NEAR MY BARN, SPLITTING TRUNK IN HALF, BREAKING LARGE BRANCH AND BLOWING BARK AND LARGE SPLINTERS FROM TRUNK.

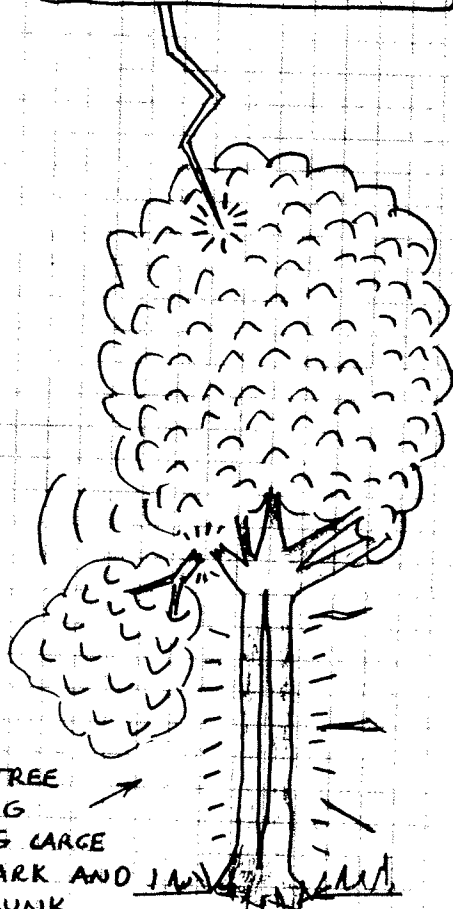
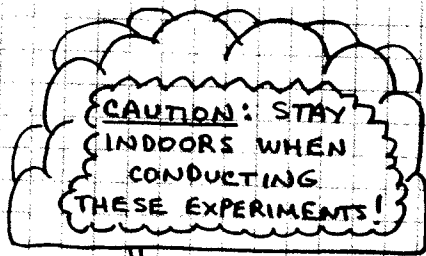

WATER TURBIDITY

SUSPENDED PARTICLES, LIQUID CONTAMINANTS AND WATER MOLECULES ALL ABSORB OR SCATTER LIGHT PASSING THROUGH WATER. THE SECCHI DISK PROVIDES A SIMPLE, TIME-TESTED MEANS FOR MEASURING WATER CLARITY.

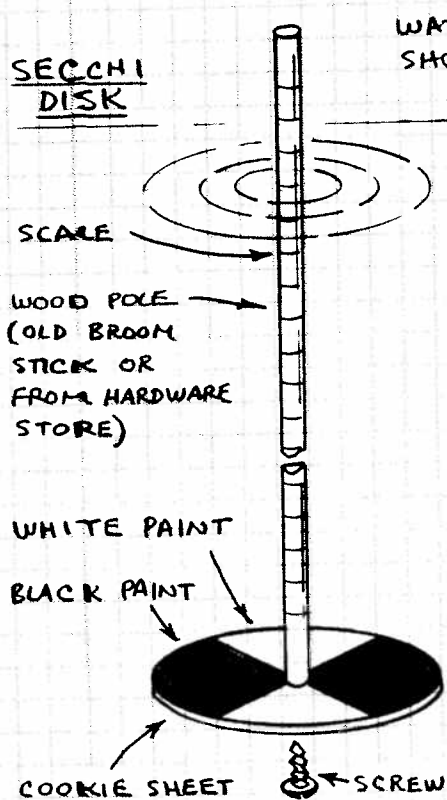

WATER SURFACE SHOULD BE SMOOTH



SUBMERGE DISK UNTIL IT DISAPPEARS. PULL DISK UP UNTIL IT IS JUST VISIBLE AND RECORD DEPTH.

POLARIZED SUNGLASSES WILL BLOCK REFLECTIONS FROM SURFACE OF WATER.

FOR DEEPER WATER REPLACE POLE WITH CORD. USE FELT TIP MARKER TO ADD SCALE TO CORD. IF NECESSARY, ADD WEIGHT TO BOTTOM OF DISK (STEEL WASHERS OR LEAD FISHING WEIGHTS).

WATER VISIBILITY RECORD
ON JUNE 27, 1676, ON THE SEA EAST OF NOVAYA ZEMLYA, CAPTAIN JOHN WOOD OBSERVED SHELLS ON THE BOTTOM "IN 80 FATHOMS WATER, WHICH IS 480 FEET...." (EOS, MARCH 1, 1994, P. 99.)
30

USE CAUTION WITH SECCHI DISK!



ELECTRONIC TURBIDIMETER

THIS CIRCUIT MEASURES THE CLARITY OF A LIQUID WITH RESPECT TO THAT OF CLEAR WATER.

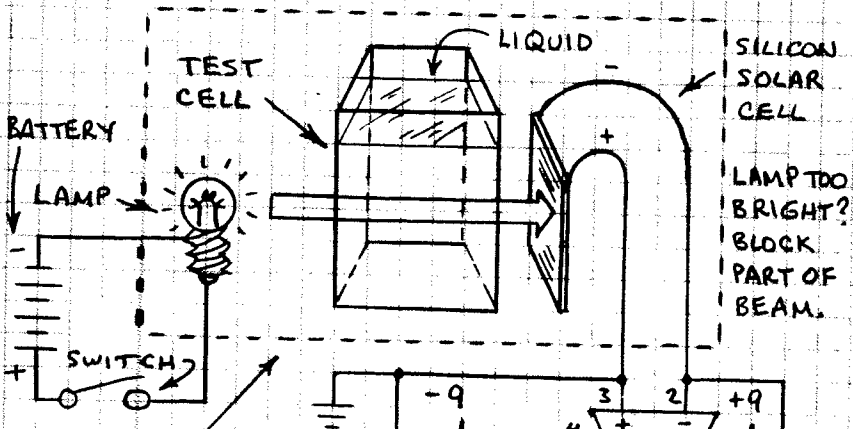

THIS PORTION OF CIRCUIT MUST BE ISOLATED FROM ALL EXTERNAL LIGHT!

TEST CELL - PLASTIC OR GLASS CONTAINER WITH FLAT SIDES.

OK TO REPLACE LAMP WITH LED:

PROCEDURE:

1. FILL TEST CELL WITH CLEAR TAP WATER OR DISTILLED WATER. WITH LAMP OFF, ADJUST R2 TO GIVE OUTPUT OF 0.00 VOLT.
2. SWITCH LAMP ON AND ADJUST R1 TO GIVE OUTPUT OF 1.00 VOLT.
3. INSERT CELL WITH SAMPLE WATER AND RECORD OUTPUT VOLTAGE.

FOR MORE SENSITIVITY, INCREASE ± 9 VOLTS TO ± 12 VOLTS AND ADJUST R1 TO GIVE 8-10 VOLTS OUT WITH CLEAN WATER IN TEST CELL.

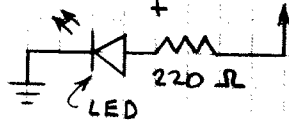

TESTING WATER

WATER IS SOMETIMES DESCRIBED AS THE UNIVERSAL SOLVENT. YOU CAN EASILY MEASURE THE CONCENTRATION OF VARIOUS IMPURITIES IN WATER USING TEST KITS FROM AQUARIUM SUPPLY STORES AND RADIO SHACK.

IMPORTANT TESTS:

HARDNESS - CAUSED BY DISSOLVED MINERALS.

AMMONIA - A WASTE PRODUCT OF BACTERIA.

NITRATE - INGREDIENT OF CROP FERTILIZER.

NITRITE - IMPAIRS ABILITY OF BLOOD TO CARRY OXYGEN.

CHLORINE - DISINFECTANT OFTEN ADDED TO WATER.

PH - CONCENTRATION OF HYDROGEN IONS.

THE PH SCALE

AN INCREASE OF 1 PH IS AN INCREASE OF 10 TIMES THE NUMBER OF HYDROGEN IONS.

RAIN WATER FALLING THROUGH UNPOLLUTED AIR HAS A PH OF ABOUT 5.6.

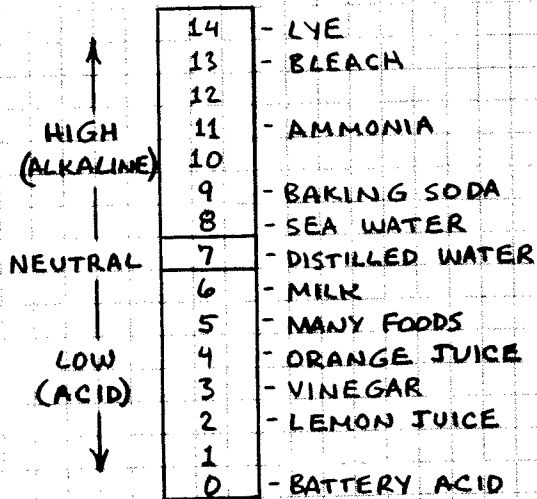

DO-IT-YOURSELF PH INDICATOR - LIQUIFY PURPLE CABBAGE IN A BLENDER. THE PURPLE JUICE WILL CHANGE COLOR AS PH CHANGES. DILUTE TO USE.

WATER AND CARBON DIOXIDE

WATER READILY ABSORBS CARBON DIOXIDE (CO_2), WHICH MAKES POSSIBLE CARBONATED BEVERAGES. MUCH OF THE CO_2 IN THE AIR IS ABSORBED BY THE OCEAN. RAIN ABSORBS CO_2 , WHICH FORMS CARBONIC ACID AND CAUSES RAIN FALLING THROUGH CLEAN AIR TO BE MILDLY ACIDIC.

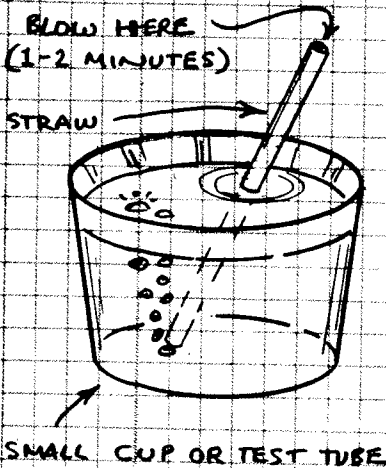

TO DEMONSTRATE ABSORPTION OF CO_2 IN WATER, BLOW BUBBLES THROUGH SMALL CUP OF WATER. USE pH INDICATOR DROPS OR PAPER TO MEASURE pH OF THE WATER BEFORE AND AFTER BLOWING. I MEASURED CHANGE IN pH FROM 6.2 TO 6.0 AFTER BLOWING 2 MINUTES INTO TEST TUBE.

ACTIVATED CARBON AND WATER

ACTIVATED CARBON IS A HIGHLY POROUS FORM OF CHARCOAL. IT IS WIDELY USED TO REMOVE IMPURITIES FROM DRINKING WATER AND WATER IN AQUARIUMS. ACTIVATED CARBON IS SOLD BY AQUARIUM STORES. THIS SIMPLE DEMONSTRATION SHOWS ITS ABILITY TO FILTER WATER.

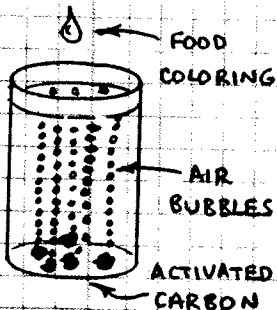

ADD ACTIVATED CARBON TO WATER AND IT WILL FIZZ AS TINY AIR BUBBLES ARE RELEASED. ADD A DROP OF FOOD COLORING, CAP THE CONTAINER AND SHAKE VIGOROUSLY. WATER WILL BECOME CLEAR AS CARBON ABSORBS THE COLORED DYE.

THE ATMOSPHERE

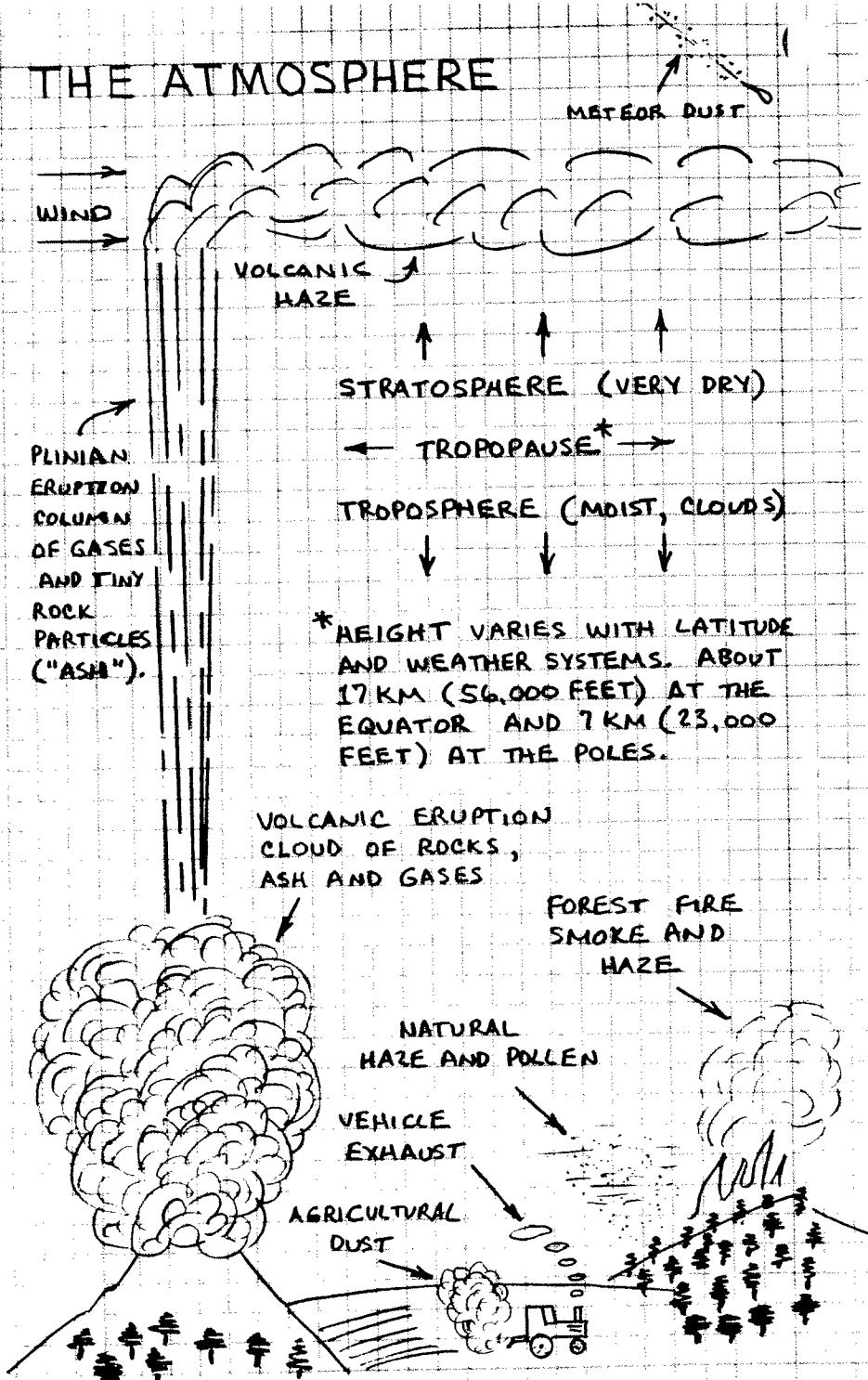

THE OZONE LAYER INCLUDES ABOUT 90% OF THE TOTAL OZONE. THE REMAINDER IS IN THE TROPOSPHERE.

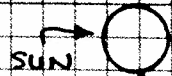

ULTRAVIOLET RAYS

OZONE LAYER ABSORBS MOST OF THE SUN'S ULTRAVIOLET RADIATION. VOLCANIC HAZE AND BOTH NATURAL AND ANTHROPOGENIC* GASES CAN DESTROY OZONE. *MAN MADE

OZONE LAYER IS 15-35 KM (49-115,000 FEET).

ATMOSPHERIC CONTENTS: 78% NITROGEN, 21% OXYGEN, 1% ARGON PLUS A DOSE OF WATER VAPOR, OZONE, CARBON DIOXIDE, METHANE, CARBON MONOXIDE, SULFUR DIOXIDE, SMOKE, DUST, SPIDER WEBS, POLLEN, INSECTS, BACTERIA AND DOZENS OF OTHER GASES AND PARTICLES.

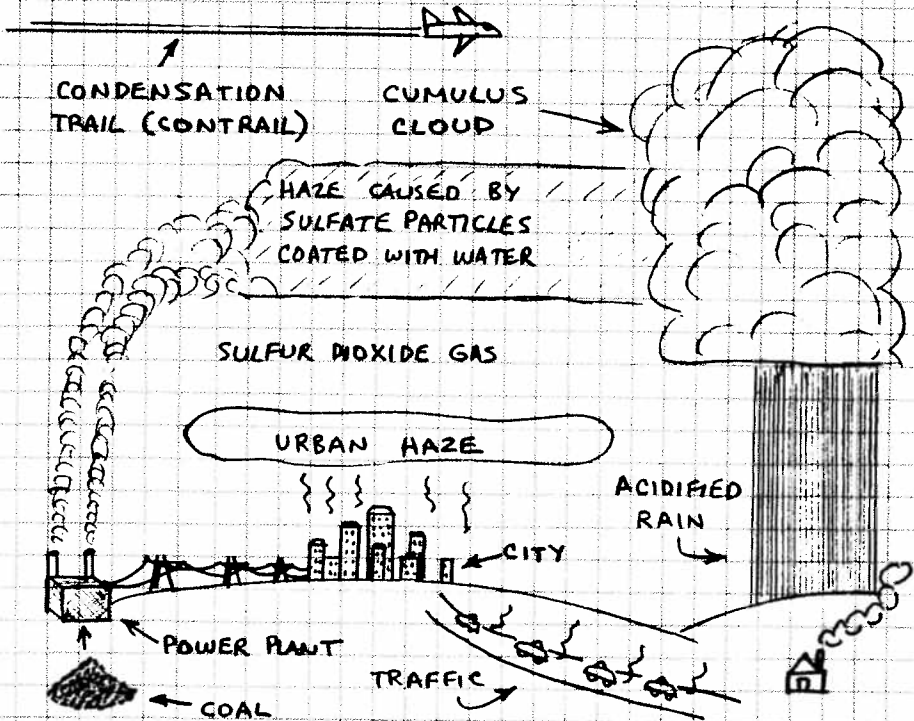

THE SOLAR RADIATION BUDGET

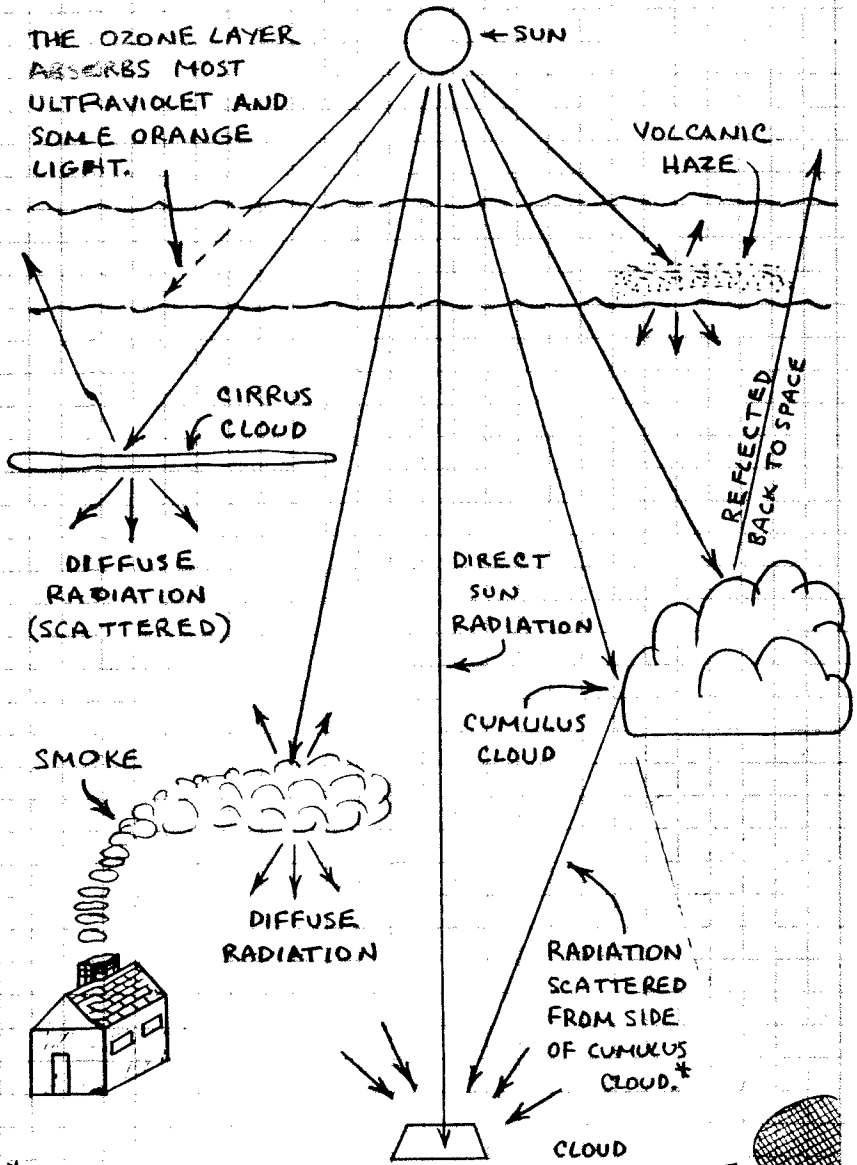

* CUMULUS CLOUDS IN CLEAR SKY CAN INCREASE SOLAR ULTRAVIOLET BY UP TO 25%. (SEE F. MIMS III & J. FREDERICK NATURE 371, p.291, 1994.)

TOTAL RADIATION IS DIRECT SUN + DIFFUSE RADIATION ON A FLAT SURFACE.

HAZE AND SOLAR RADIATION

NATURAL HAZE IS CAUSED BY SMOKE FROM FOREST FIRES, WATER VAPOR FOG, VERY THIN OVERCAST CIRRUS OR STRATUS CLOUDS, DUST, SEA SALT AND PHOTOCHEMICAL REACTIONS OF SUNLIGHT AND VARIOUS GASES EMITTED BY PLANTS.

ANTHROPOGENIC HAZE, A BY PRODUCT OF HUMAN ACTIVITY, IS CAUSED BY EMISSIONS FROM COAL-FIRED POWER PLANTS, FIREPLACE SMOKE, CONTRAILS FROM HIGH ALTITUDE AIRCRAFT (WHICH CAN COVER MUCH OF THE SKY) AND PHOTOCHEMICAL REACTIONS OF SUNLIGHT AND GASES EMITTED BY INTERNAL COMBUSTION ENGINES. ANTHROPOGENIC HAZE IS ESPECIALLY BAD OVER THE EASTERN PORTIONS OF EUROPE AND THE UNITED STATES.



NO HAZE: SUN IS BRILLIANT DISK IN DEEP BLUE SKY. CLOUDS STAND OUT.

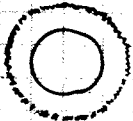

SOME HAZE: SUN SURROUNDED BY BRIGHT GLOW (CIRCUMSOLAR RADIATION). CLOUDS NEAR HORIZON DIFFICULT TO RESOLVE.



CONSIDERABLE HAZE: SUN DIM. ENTIRE SKY PALE, MILKY BLUE. CLOUDS BLEND INTO HAZE AND DIFFICULT TO SEE.

HAZE SIGNIFICANTLY REDUCES DIRECT RADIATION, SIGNIFICANTLY INCREASES DIFFUSE RADIATION AND SLIGHTLY REDUCES TOTAL RADIATION.

HAZE SCATTERS SOME RADIATION BACK INTO SPACE, THUS CAUSING A COOLING EFFECT.

HAZE GREATLY INCREASES DIFFUSE RADIATION ON PLANTS AND ANIMALS SHADED FROM DIRECT SUN. DURING SUMMER OF 1994, I FOUND THAT A PERSON SHADED FROM DIRECT SUN BY A SMALL UMBRELLA CAN RECEIVE 30% OR MORE SOLAR ULTRAVIOLET AT A HAZY SITE NEAR SEA LEVEL THAN AT THE TOP OF PIKES PEAK (ELEVATION: 4,301 METERS OR 14,110 FEET).

ATMOSPHERIC OPTICAL THICKNESS

ATMOSPHERIC OPTICAL THICKNESS (AOT) IS A MEASURE OF THE CLARITY OF THE AIR IN A VERTICAL COLUMN THROUGH THE ATMOSPHERE. AOT INDICATES THE AMOUNT OF HAZE, SMOG, SMOKE, DUST AND VOLCANIC AEROSOLS IN THE ATMOSPHERE. A SMALL AOT INDICATES A CLEAN ATMOSPHERE.

YOU CAN MEASURE AOT WITH A SUN PHOTOMETER LIKE THE ONE ON PAGE 39 AND A CALCULATOR WITH A \ln (NATURAL LOGARITHM) KEY. A SIMPLIFIED FORMULA FOR AOT IS:

$$AOT = (\ln I_0 / \ln I) / m$$

I_0 IS THE SIGNAL THE SUN PHOTOMETER WOULD MEASURE ABOVE THE ATMOSPHERE — THE EXTRATERRESTRIAL (ET) CONSTANT.

I IS THE SIGNAL DURING A SPECIFIC SUN OBSERVATION.

m IS THE AIR MASS (SEE BELOW) DURING THE OBSERVATION.

AIR MASS (m)

AIR MASS IS $1 / \sin \theta$, WHERE θ IS THE ANGLE OF THE SUN ABOVE THE HORIZON.

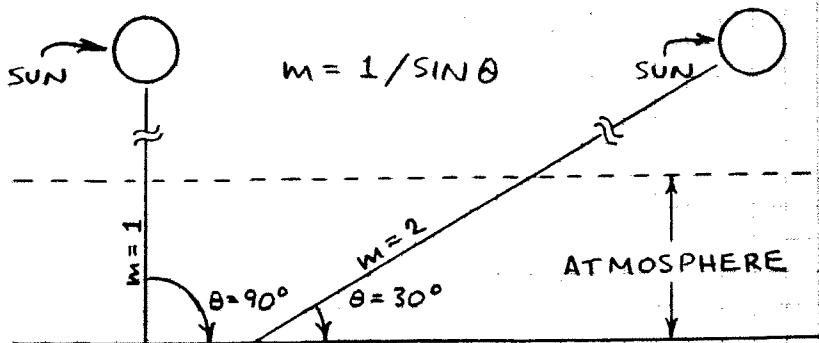

LED SUN PHOTOMETER

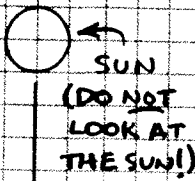

LIGHT-EMITTING DIODES EMIT AND DETECT LIGHT OVER A RELATIVELY NARROW BAND OF WAVELENGTHS (30-150 NANOMETERS). THIS MEANS AN LED CAN BE USED IN A SUN PHOTOMETER WITHOUT AN EXTERNAL OPTICAL FILTER.

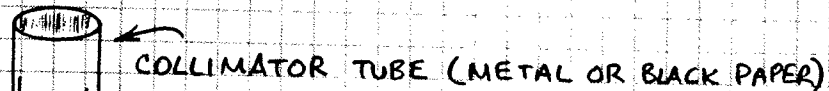
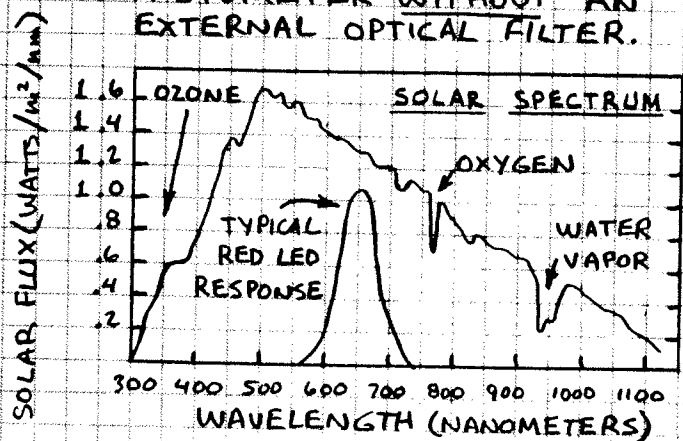

INCREASE TO INCREASE GAIN → R1 470K

REFERENCE:
F.M. MIMS III,
"SUN PHOTOMETER WITH LEDs..."
APPLIED OPTICS
VOL. 31, NO. 33,
6965-6967, 1992.

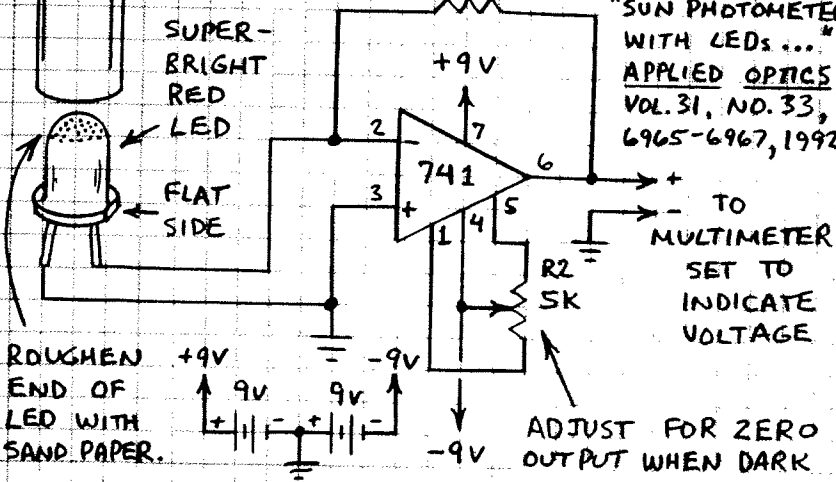

SOLAR CELL RADIOMETER

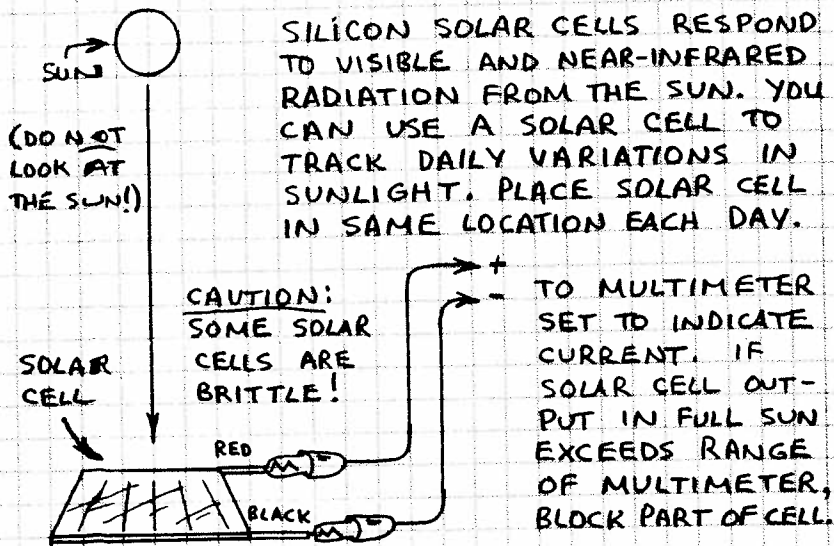

SOLAR CELL SUN PHOTOMETER

THE OPTICAL THICKNESS OF THE ATMOSPHERE (SEE PAGE 38) CAN BE MEASURED WITH A RADIOMETER THAT RESPONDS TO A NARROW BAND OF LIGHT WAVELENGTHS. A SOLAR CELL RADIOMETER CAN BE CONVERTED INTO A SUN PHOTOMETER.

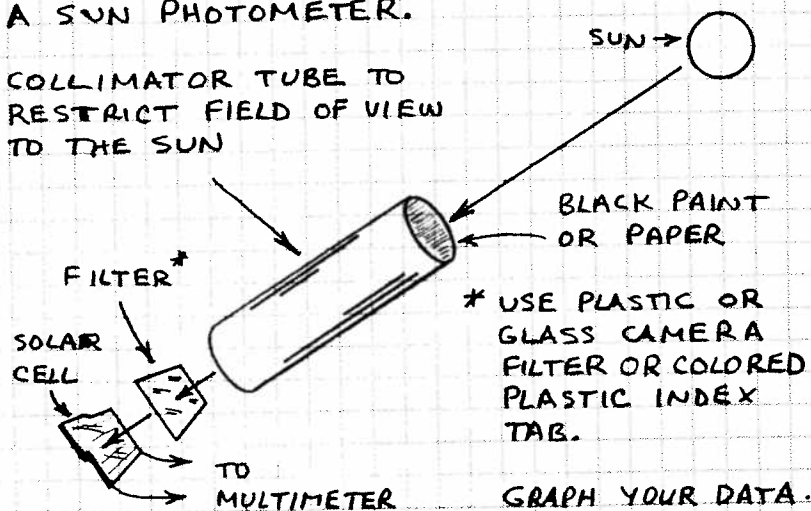

HOW TO MEASURE THE SUN'S ANGLE

USE VARIOUS ASTRONOMY COMPUTER PROGRAMS TO FIND THE SUN'S ANGLE. OR MEASURE THE SUN'S ANGLE TO WITHIN ABOUT $\pm 1^\circ$ WITH A SUN ANGLE INDICATOR:

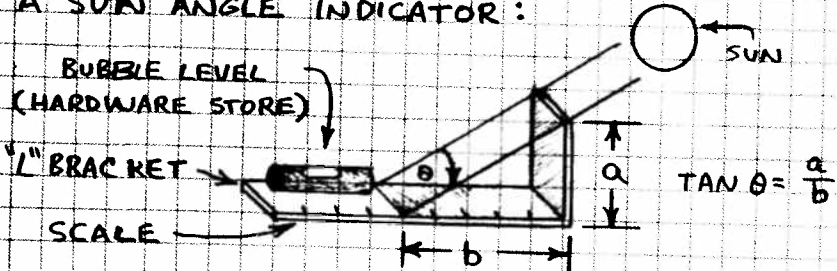

HOW TO MEASURE THE ET* CONSTANT

FIRST, MEASURE I FOR 1/2 DAY, EVERY 30 MINUTES NEAR NOON, MORE OFTEN AT LOWER SUN ANGLES. THEN PLOT \ln OF I VS. m AT EACH SUN OBSERVATION. DRAW A STRAIGHT LINE THROUGH THE POINTS. THE I_0 OF THE ET CONSTANT IS WHERE THE LINE INTERCEPTS THE VERTICAL (Y) AXIS WHERE $m=0$. HINT: USE THE LINEAR REGRESSION FEATURE OF A CALCULATOR OR COMPUTER SPREADSHEET TO FIND THE INTERCEPT AT $m=0$. *EXTRATERRESTRIAL

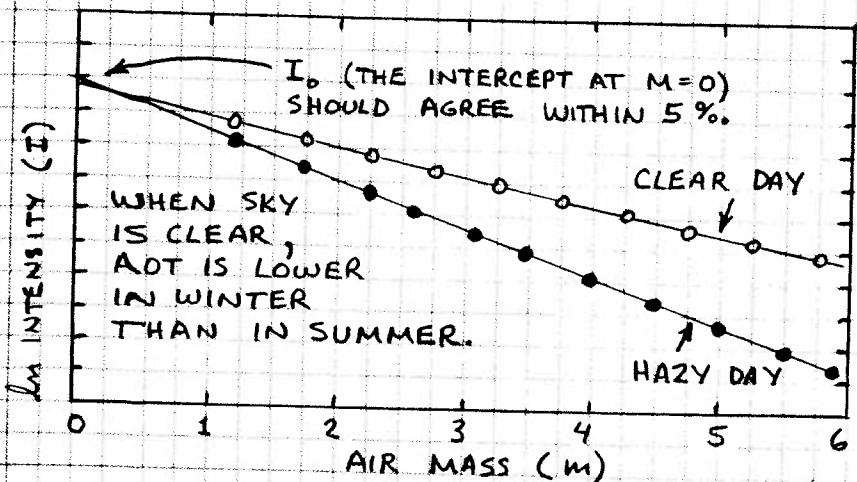

TOTAL SKY SOLAR RADIOMETER

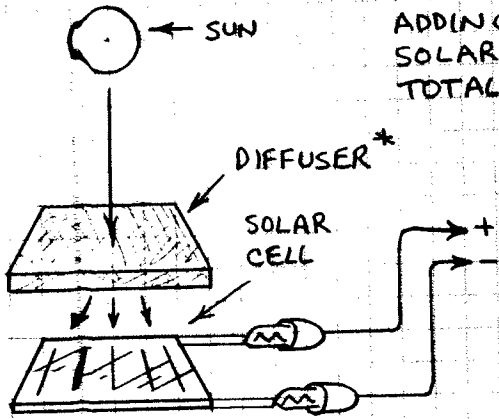

ADDING DIFFUSER TO SOLAR CELL IMPROVES TOTAL SKY RESPONSE.

TO MULTIMETER SET TO INDICATE CURRENT. IF THE SOLAR CURRENT IN FULL SUN EXCEEDS RANGE OF MULTIMETER BLOCK PART OF CELL.

* TRANSLUCENT PLASTIC FROM LIGHT FIXTURE, FOOD STORAGE CONTAINER LID, ETC.

PLACE SOLAR CELL ON OPAQUE, RIGID SURFACE. PLACE DIFFUSER OVER SOLAR CELL AND USE HOT MELT GLUE OR SILICONE SEALANT TO CEMENT EDGES OF DIFFUSER TO SURFACE. PLACE DETECTOR IN SAME LOCATION EACH DAY IF YOU WANT TO COMPARE DAY TO DAY CHANGES AND TRENDS. BE SURE YOUR HEAD AND BODY DO NOT SHADE SOLAR CELL FROM PART OF THE SKY WHEN YOU MAKE MEASUREMENTS.

HERE'S A TYPICAL PLOT OF SOLAR RADIATION FOR A FULL DAY:

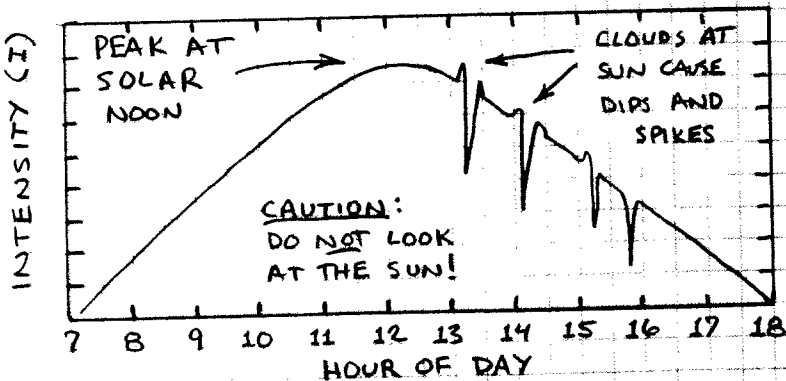

SHADOW BAND RADIOMETER

A SHADOW BAND (OR RING) IS A STRIP OF OPAQUE, FLEXIBLE PLASTIC, METAL OR STIFF PAPER BENT INTO A HALF CIRCLE. THE BAND IS ORIENTED EAST AND WEST AND TILTED TO FACE THE SUN. A LIGHT SENSOR UNDER THE BAND WILL BE SHADED AS THE SUN MOVES ACROSS THE SKY. IT WILL THEN RECEIVE ONLY THE DIFFUSE RADIATION FROM THE SKY AND CLOUDS.

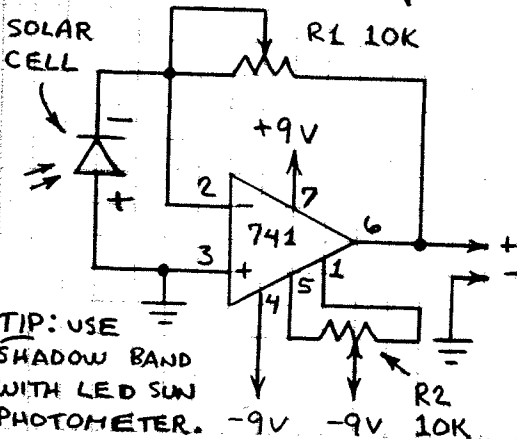
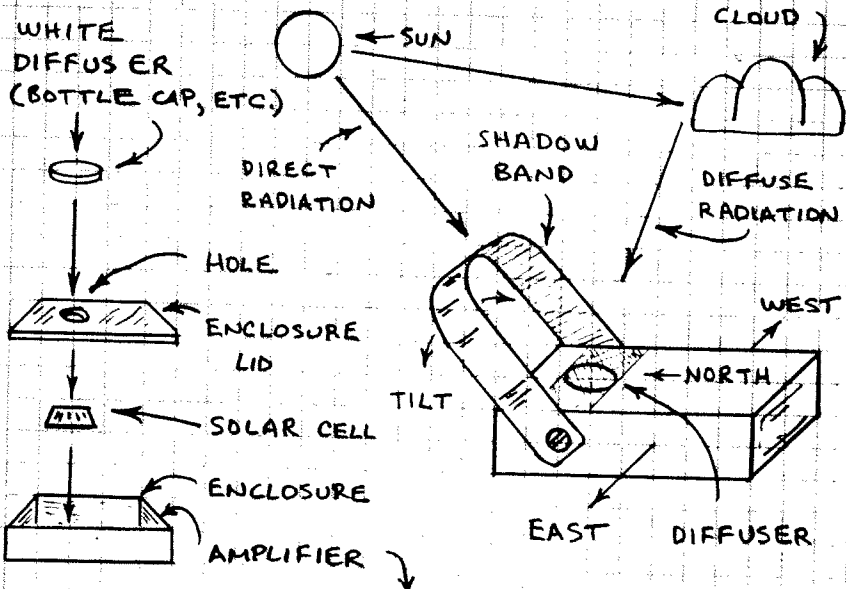

TIP: USE SHADOW BAND WITH LED SUN PHOTOMETER.

CEMENT DIFFUSER AND SOLAR CELL TO ENCLOSURE LID. SET R2 TO GIVE 0 VOLTS WHEN SOLAR CELL DARK.

TO MULTIMETER

SET R1 TO GIVE OUTPUT OF 2 TO 5 VOLTS ON SUNNY DAY.

MEASURING TOTAL AND DIFFUSE RADIATION

WHEN THE ATMOSPHERIC OPTICAL THICKNESS (AOT) MEASURED BY A SUN PHOTOMETER IS HIGH, THE DIRECT SOLAR RADIATION IS REDUCED AND DIFFUSE RADIATION IS INCREASED. THE LED SUN PHOTOMETER ON PAGE 39 CAN BE MODIFIED TO MEASURE THE TOTAL AND DIFFUSE RADIATION AND THE RATIO OF THE DIFFUSE OR DIRECT TO THE TOTAL RADIATION. FIRST MODIFY THE LED LIKE THIS :

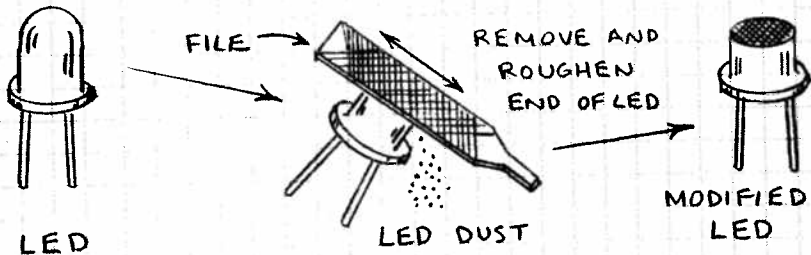

NEXT, ARRANGE THE PHOTOMETER SO THE FLAT TOP OF THE LED LOOKS STRAIGHT UP AT THE ZENITH SKY. USE A BUBBLE LEVEL TO MAKE SURE THE PHOTOMETER IS LEVEL EACH TIME YOU MAKE A MEASUREMENT. ADJUST THE RESISTANCE OF R1 FOR BEST RESULTS — BUT MAKE ANY CHANGE PERMANENT SO YOUR MEASUREMENTS WILL BE COMPARABLE.

TOTAL RADIATION
OUTPUT WHEN LED
POINTED AT ZENITH.

DIFFUSE RADIATION
OUTPUT WHEN LED
SHADED AS SHOWN.

DIRECT RADIATION
TOTAL - DIFFUSE

SUGGESTION:
TRACK RATIO OF
DIRECT OR DIFFUSE
TO TOTAL OVER TIME.

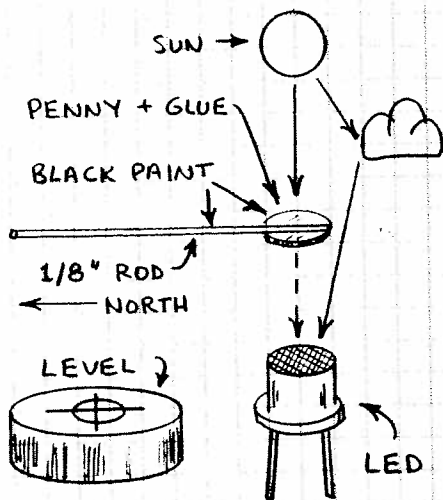

MEASURING THE SOLAR AUREOLE

THE RING OF LIGHT AROUND THE SUN ON ALL BUT THE CLEAREST DAYS IS THE SOLAR AUREOLE OR THE CIRCUMSOLAR RADIATION. THE SIZE AND BRIGHTNESS OF THE AUREOLE IS DETERMINED BY HAZE. YOU CAN USE A SUN PHOTOMETER TO MEASURE THE AUREOLE. HERE ARE THE BASICS:

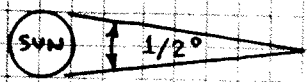

THE SUN SUBTENDS AN ANGLE OF ABOUT 0.5° .

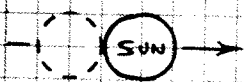

THE SUN MOVES ITS DIAMETER IN 2 MINUTES.

POINT THE PHOTOMETER COLLIMATOR TUBE AT THE SUN, SECURE IT IN PLACE, AND ALLOW THE SUN TO DRIFT PAST THE COLLIMATOR'S FIELD OF VIEW.

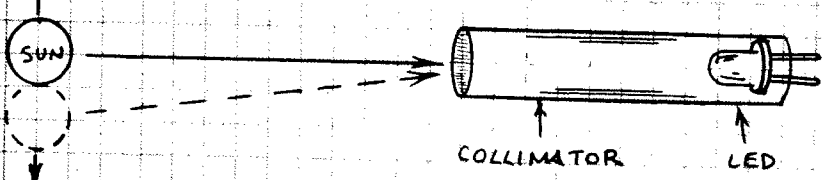

COLLIMATOR TUBE HAS NO SHADOW WHEN IT IS POINTED DIRECTLY AT THE SUN.

HERE'S ONE WAY TO PLOT YOUR MEASUREMENTS:

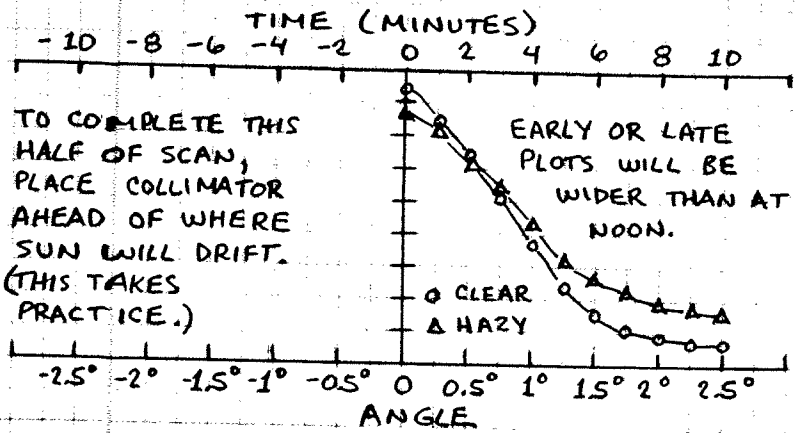

SUNSHINE DURATION RECORDER

THE TOTAL TIME DURING A DAY WHEN THE SUN IS NOT BLOCKED BY CLOUDS IS AN IMPORTANT ENVIRONMENTAL PARAMETER IN AGRICULTURE AND STUDIES OF THE EFFECT OF CLOUDS ON THE EARTH'S TEMPERATURE. IN 1853 J.F. CAMPBELL INVENTED A SUNSHINE RECORDER:

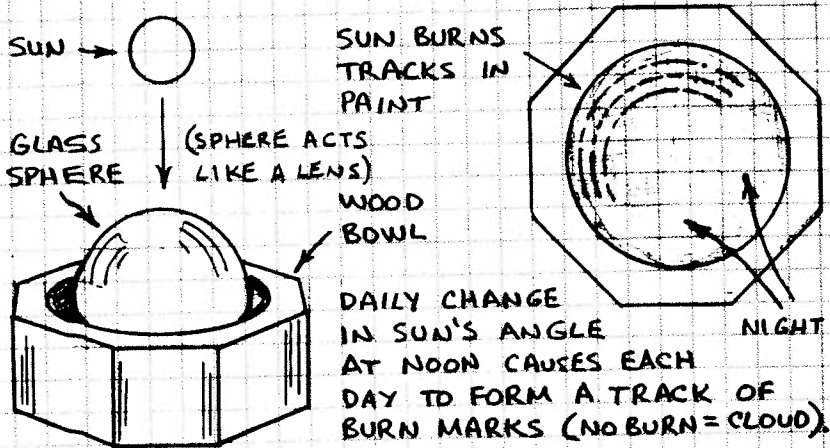

PAPER SUNSHINE RECORDER

SUNLIGHT DARKENS NEWSPRINT AND CAUSES SOME COLORED CONSTRUCTION PAPER TO FADE. PLACE STRIP OF BLUE OR RED CONSTRUCTION PAPER UNDER STRIP OF BLACK PAPER WITH SLOT CUT OUT TO PASS SUN LIGHT. MOVE SLOT SAME DISTANCE EACH MORNING. AFTER A WEEK, PAPER STRIP WILL HAVE SEVEN FADED RECTANGLES. THE MOST FADED RECTANGLES RECEIVED THE MOST SUNLIGHT.

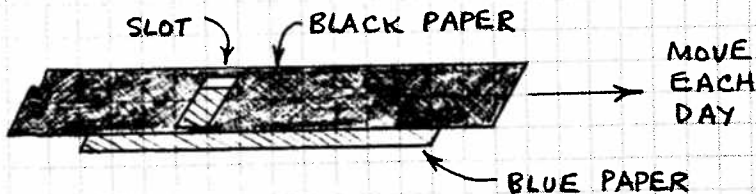

SECURE STRIPS IN CLIP BOARD.

POP BOTTLE SUNSHINE RECORDER

THIS SIMPLE APPARATUS INDICATES PASSAGE OF LARGE CLOUD MASSES AS UNFADED STRIPES ON BLUE CONSTRUCTION PAPER. RANDOM CLOUDS PASSING OVER SUN MAY CAUSE LESS FADING THAN A CLEAR DAY.

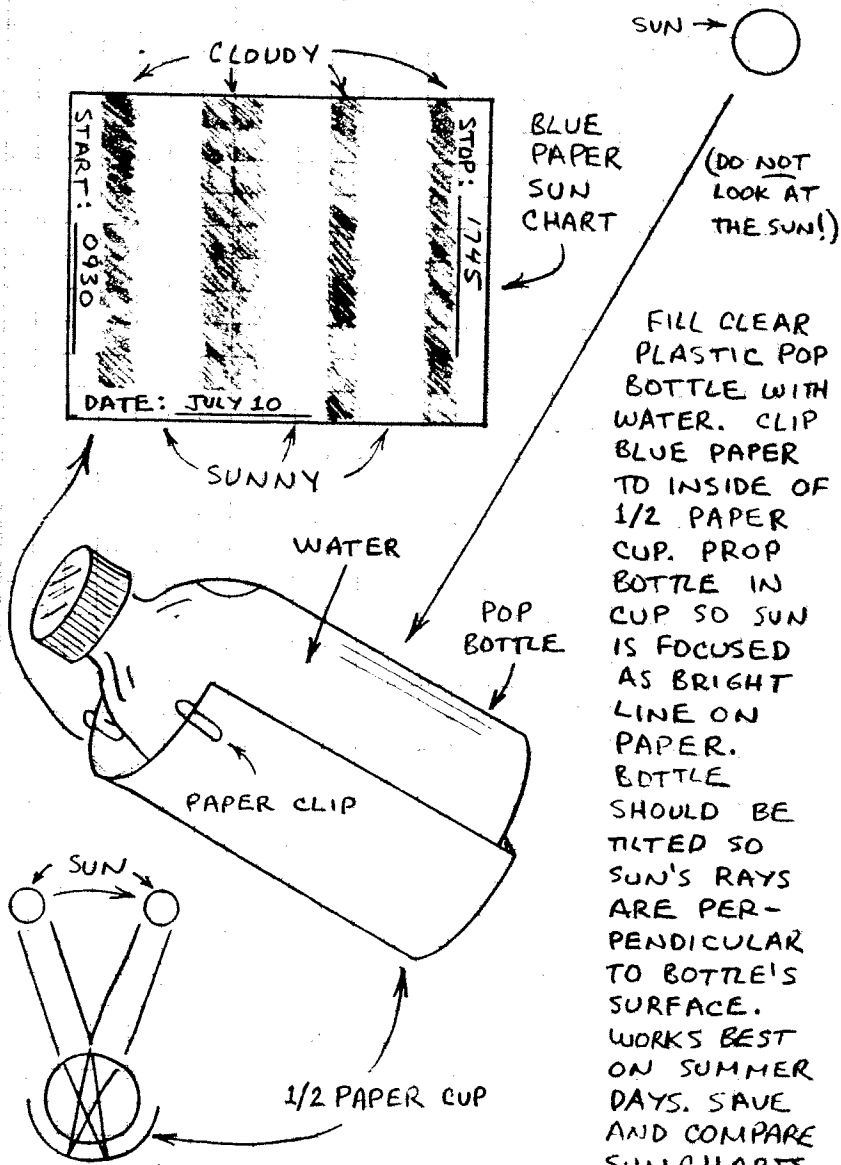

FILL CLEAR PLASTIC POP BOTTLE WITH WATER. CLIP BLUE PAPER TO INSIDE OF 1/2 PAPER CUP. PROP BOTTLE IN CUP SO SUN IS FOCUSED AS BRIGHT LINE ON PAPER. BOTTLE SHOULD BE TILTED SO SUN'S RAYS ARE PERPENDICULAR TO BOTTLE'S SURFACE. WORKS BEST ON SUMMER DAYS. SAVE AND COMPARE SUN CHARTS.

ELECTRONIC SUNSHINE RECORDER

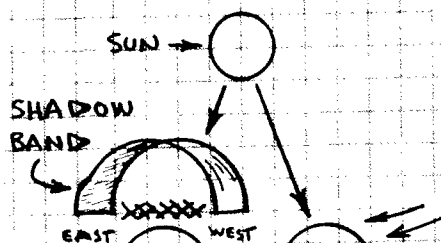

THIS CIRCUIT MEASURES THE TOTAL TIME THE SUN SHINES DURING A DAY.

PC1-2 ARE CADMIUM SULFIDE PHOTORESISTORS.

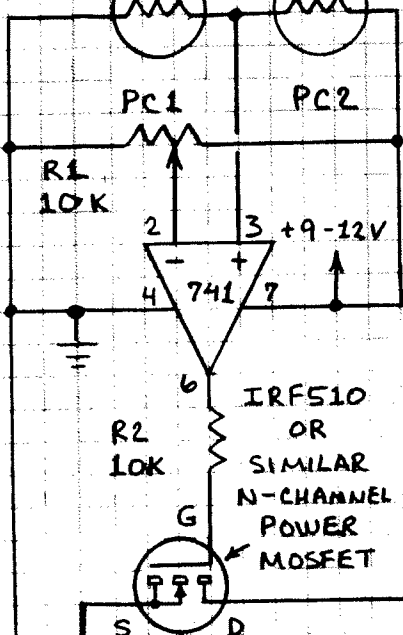

PC1 IS CONCEALED FROM THE DIRECT SUN BY A SHADOW BAND. BOTH PC1 AND PC2 LOOK STRAIGHT UP. WITH PC1 IN SHADE AND PC2 IN SUN, ADJUST R1 UNTIL RELAY PULLS IN ("CLICK") AND CLOCK STARTS. SHADE PC2 AND RELAY SHOULD DROP OUT, STOPPING CLOCK. SET CLOCK TO 12:00:00 TO BEGIN. LOG TOTAL ELAPSED SUNSHINE TIME IN NOTEBOOK.

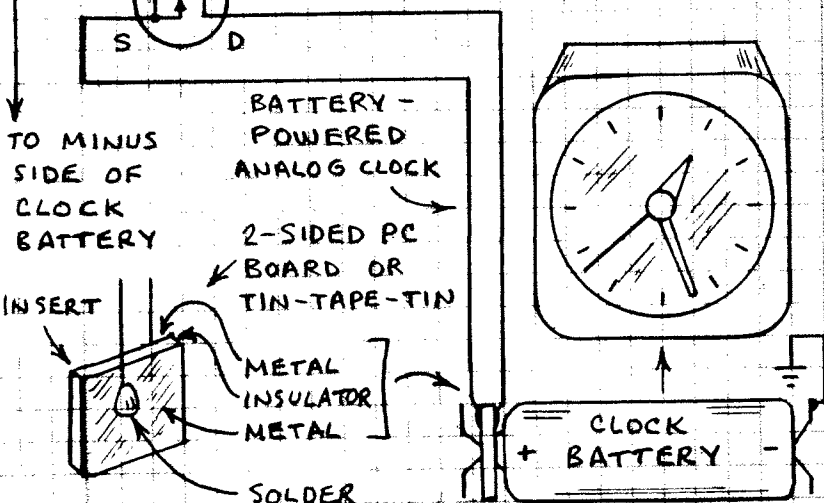

Radio Shack

A Division of Tandy Corporation
Fort Worth, TX 76102

PRINTED IN U.S.A.



62-5019