







ELECTRONIC CIRCUIT SYMBOLS AND DIAGRAMS

 CONNECTED WIRES	 UNCONNECTED WIRES	 POSITIVE (+) VOLTAGE CONNECTION	 GROUND CONNECTION	 RESISTOR																																																	
 POTENTIOMETER	 DISK CAPACITOR	 ELECTROLYTIC CAPACITOR	 LIGHT-EMITTING DIODE (LED)	 NPN NPN BIPOLAR TRANSISTOR																																																	
 POWER MOSFET TRANSISTOR	 INTEGRATED CIRCUIT	 TRANSFORMER	 MAGNETIC SPEAKER	 PIEZOELECTRIC BUZZER																																																	
 CONSOLE ROTATION SENSOR	 CONSOLE TOUCH SENSOR	 CONSOLE MAGNET SENSOR	 MAGNET SWITCH SENSOR CARD	 MAGNET																																																	
RESISTOR COLOR CODE 		 THERMISTOR SENSOR CARD	 PHOTO-RESISTOR SENSOR CARD	 PHOTO-TRANSISTOR SENSOR CARD																																																	
<table style="width: 100%; border-collapse: collapse;"> <tbody> <tr> <td>BLACK</td> <td>0</td> <td>0</td> <td>X</td> <td>1</td> </tr> <tr> <td>BROWN</td> <td>1</td> <td>1</td> <td>X</td> <td>10</td> </tr> <tr> <td>RED</td> <td>2</td> <td>2</td> <td>X</td> <td>100</td> </tr> <tr> <td>ORANGE</td> <td>3</td> <td>3</td> <td>X</td> <td>1,000</td> </tr> <tr> <td>YELLOW</td> <td>4</td> <td>4</td> <td>X</td> <td>10,000</td> </tr> </tbody> </table>	BLACK	0	0	X	1	BROWN	1	1	X	10	RED	2	2	X	100	ORANGE	3	3	X	1,000	YELLOW	4	4	X	10,000	<table style="width: 100%; border-collapse: collapse;"> <tbody> <tr> <td>GREEN</td> <td>5</td> <td>5</td> <td>X</td> <td>100,000</td> </tr> <tr> <td>BLUE</td> <td>6</td> <td>6</td> <td>X</td> <td>1,000,000</td> </tr> <tr> <td>VIOLET</td> <td>7</td> <td>7</td> <td>X</td> <td>10,000,000</td> </tr> <tr> <td>GRAY</td> <td>8</td> <td>8</td> <td>X</td> <td>100,000,000</td> </tr> <tr> <td>WHITE</td> <td>9</td> <td>9</td> <td></td> <td></td> </tr> </tbody> </table>	GREEN	5	5	X	100,000	BLUE	6	6	X	1,000,000	VIOLET	7	7	X	10,000,000	GRAY	8	8	X	100,000,000	WHITE	9	9			THE FOURTH BAND IS THE TOLERANCE: GOLD = +/- 5% SILVER = +/- 10%	
BLACK	0	0	X	1																																																	
BROWN	1	1	X	10																																																	
RED	2	2	X	100																																																	
ORANGE	3	3	X	1,000																																																	
YELLOW	4	4	X	10,000																																																	
GREEN	5	5	X	100,000																																																	
BLUE	6	6	X	1,000,000																																																	
VIOLET	7	7	X	10,000,000																																																	
GRAY	8	8	X	100,000,000																																																	
WHITE	9	9																																																			

RADIOSHACK ELECTRONIC SENSORS LAB

BY FORREST M. MIMS III

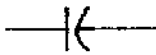
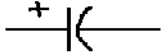
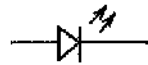
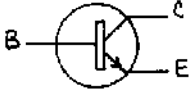
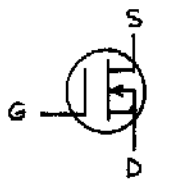
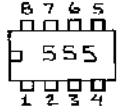
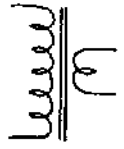
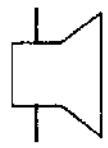
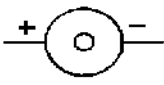
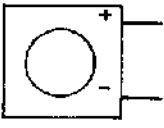
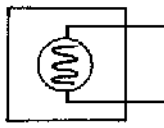
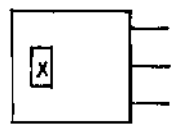
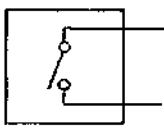
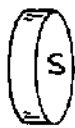
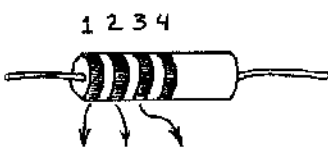
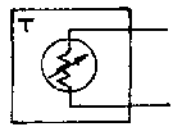
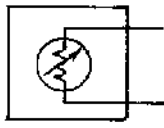
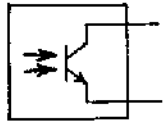
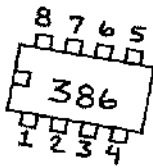
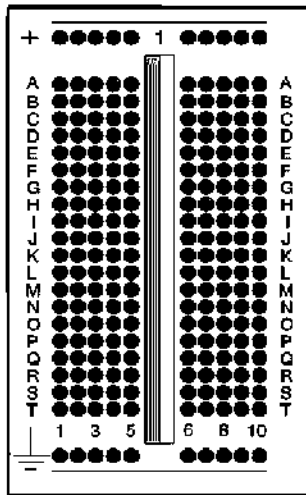
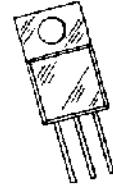

FIRST PRINTING 2001

COPYRIGHT © 2001 BY RADIOSHACK CORPORATION. ALL RIGHTS RESERVED.

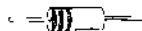

CONTENTS

INTRODUCTION

HOW TO CARE FOR YOUR ELECTRONIC SENSORS LAB	4
BATTERY INSTALLATION AND CARE	4
FREQUENTLY ASKED QUESTIONS	5
INSTITUTE OF ELECTRICAL AND ELECTRONICS ENGINEERS (IEEE).....	5
THE CONSOLE ELECTRONIC PARTS	6
PARTS SUPPLIED WITH YOUR ELECTRONIC SENSORS LAB	8-9
ICs PROVIDED WITH YOUR ELECTRONIC SENSORS LAB	10
SENSORS SUPPLIED WITH YOUR ELECTRONIC SENSORS LAB	12-13
THE SOLDERLESS BREADBOARD	14
HOW TO ASSEMBLE CIRCUITS	15
MORE ABOUT ASSEMBLY METHODS	16
ELECTRONIC CIRCUIT SYMBOLS AND DIAGRAMS	17
A PICTORIAL VIEW OF A TOUCH-SENSITIVE LED FLASHER	18
BUILD AN LED FLASHER THAT RESPONDS TO TOUCH	19
GETTING STARTED: CHECKING OUT THE CIRCUIT	20
GETTING STARTED: REVIEW WHAT YOU HAVE LEARNED	21
TROUBLESHOOTING PROBLEM CIRCUITS	22
MORE ABOUT SENSORS	23
USE A COMPASS TO DETECT MAGNETIC FIELDS	24
USE A COMPASS TO DETECT AN ELECTROMAGNETIC FIELD	25
USE A MAGNET TO SWITCH ON AN LED	26
USE A MAGNET TO ALTER THE BUZZER	26
USE A MAGNET TO SWITCH AN LED OFF	27
USE A MAGNET TO SWITCH THE BUZZER OFF	27
BUILD A RED-GREEN MAGNET DETECTOR	28
BUILD A FERROUS METAL DETECTOR	29
BUILD A BUZZER VIBRATION DETECTOR	30
BUILD AN LED VIBRATION DETECTOR	30
USE A MAGNET TO BUILD A PENDULUM METRONOME	31
HOW TO USE THE ROTATION SENSOR	32
BUILD AN AUDIO OUTPUT ROTATION SENSOR	32
BUILD AN LED OUTPUT ROTATION SENSOR	32
BUILD A DIRECTION OF ROTATION SENSOR	33
BUILD A BARGRAPH DIRECTION OF ROTATION INDICATOR	34
BUILD AN AUDIO OUTPUT ROTATION SENSOR	35
BUILD AN ELECTROMAGNETIC SIGNAL RECEIVER	36
ADD AN LED BARGRAPH READOUT TO THE ELECTROMAGNETIC SIGNAL RECEIVER	37
BUILD AN ELECTROMAGNETIC PULSE SOURCE FOR THE ELECTROMAGNETIC SIGNAL RECEIVER	38
USE A MAGNET TO CAUSE AN LED TO FLASH AND FLICKER	39
USE A MAGNET TO ALTER AN AUDIO TONE	40
BUILD A COMPASS BOUNCER	41
BUILD A BASIC MAGNET DETECTOR	42
USE A MAGNET TO SWITCH ON THE BUZZER	43
USE A MAGNET TO SWITCH OFF THE BUZZER	44
USE A MAGNET TO SWITCH ON AN LED FOR A FIXED TIME	45
USE A MAGNET TO SWITCH ON A FLASHING LED	46
USE A MAGNET TO STOP A FLASHING LED	47
USE THE MAGNET TO SWITCH ON A TONE	48
USE THE MAGNET TO SWITCH OFF A TONE	49
USE A MAGNET TO CONTROL A PULSATING TONE GENERATOR	50
USE THE MAGNET TO TRIGGER TWO TONES	51
USE THE TOUCH SENSOR TO SWITCH OFF AN LED	52

USE THE TOUCH SENSOR TO SWITCH ON AN LED	53
USE THE TOUCH SENSOR TO SWITCH OFF A TONE	54
USE THE TOUCH SENSOR TO SWITCH ON A TONE	55
USE THE TOUCH SENSOR TO KEEP AN LED ON OR OFF	56
USE THE TOUCH SENSOR TO KEEP A TONE ON OR OFF	57
USE THE TOUCH SENSOR TO SWITCH OFF THE BUZZER	58
USE THE TOUCH SENSOR TO SWITCH THE BUZZER ON	59
USE A TOUCH SENSOR TO TURN GREEN LED ON/RED LED OFF	60
USE A TOUCH SENSOR TO CHANGE THE TONE FREQUENCY	61
BUILD A PRESSURE-SENSITIVE RISING TONE OSCILLATOR	62
BUILD A PRESSURE-SENSITIVE FALLING TONE OSCILLATOR	63
BUILD A PRESSURE-ACTIVATED TONE GENERATOR	64
USE PRESSURE TO SPEED UP A FLASHING LED	65
USE PRESSURE TO SLOW A FLASHING LED	66
BUILD A SIMPLE SCALE WITH A BARGRAPH READOUT	67
USE THE PROBE SENSOR TO DETECT RESISTANCE	68
BUILD A HIGH-SENSITIVITY SKIN RESISTANCE MONITOR	69
BUILD A MOISTURE AND WATER DETECTION BUZZER	70
BUILD A DIGITAL LOGIC WATER DETECTION CIRCUIT	71
BUILD A LED YES-NO WATER INDICATOR	72
BUILD A PENDULUM SWITCH	73
BUILD A TEMPERATURE-CONTROLLED AUDIO OSCILLATOR	74
BUILD A TEMPERATURE-CONTROLLED THERMOSTAT	75
BUILD A TEMPERATURE CONTROLLED BUZZER	76
BUILD A REMOTE TEMPERATURE TRANSMITTER	77
BUILD A TEMPERATURE-CONTROLLED CHIRP GENERATOR	78
BUILD A TEMPERATURE-CONTROLLED BARGRAPH READOUT	79
BUILD A LIGHT-ACTIVATED BUZZER	80
BUILD A LIGHT OR DARK ACTIVATED TONE	81
BUILD A LIGHT-INCREASES-FREQUENCY AUDIO OSCILLATOR	82
BUILD A LIGHT REDUCES FREQUENCY AUDIO OSCILLATOR	83
BUILD AN OBJECT DETECTOR	84
BUILD A BASIC PHOTORESISTOR LIGHT METER	85
BUILD AN ULTRA-SENSITIVE LIGHT METER	86
BUILD AN OPTICAL FEEDBACK CIRCUIT	87
BUILD A LIGHT-ACTIVATED BUZZER	88
BUILD A DARK-ACTIVATED BUZZER	88
BUILD A LIGHT-ACTIVATED TONE	89
BUILD A DARK-ACTIVATED TONE	89
BUILD A BASIC PHOTOTRANSISTOR LIGHT METER	90
BUILD A SUPER-SENSITIVE RADIOMETER	91
BUILD A LIGHT-CONTROLLED OSCILLATOR	92
BUILD A PHOTOTRANSISTOR FEEDBACK CIRCUIT	93
BUILD A LIGHT BEAM AUDIO RECEIVER	94
BUILD AN LED TRANSMITTER FOR THE LIGHT RECEIVER	95
GOING FURTHER WITH ELECTRONIC SENSORS	96

A NOTE FROM THE AUTHOR...

YOU ARE ABOUT TO ENTER THE WORLD OF ELECTRONIC SENSORS. IT'S A FASCINATING PLACE WHERE YOU WILL EXPERIMENT WITH ELECTRONIC DEVICES THAT RESPOND TO TOUCH, PRESSURE, MAGNETISM, LIGHT, TEMPERATURE, AND ROTATION. WHEN YOU BUILD AND EXPERIMENT WITH THE PROJECTS IN THIS LAB KIT, YOU WILL HAVE FUN WHILE LEARNING HOW ELECTRONIC CIRCUITS RESPOND TO THE WORLD AROUND THEM. I HOPE YOU ENJOY EXPERIMENTING WITH THESE PROJECTS AS MUCH AS I DID DESIGNING THEM.

FORREST M. MIMS III

HOW TO CARE FOR YOUR ELECTRONIC SENSORS LAB

1. ALWAYS PUSH THE POWER SWITCH TO THE OFF POSITION (DOWN) BEFORE BUILDING OR MODIFYING A CIRCUIT AND WHEN YOU ARE NOT USING THE SENSORS LAB.
2. IF A CIRCUIT FAILS TO WORK PROPERLY WHEN THE POWER SWITCH IS PUSHED ON (UP), PUSH THE SWITCH OFF (DOWN) UNTIL YOU FIND AND CORRECT THE PROBLEM (SEE PAGE 22).
3. OVERHEATED ELECTRONIC COMPONENTS MAY EMIT A DISTINCTIVE ODOR. VERY IMPORTANT: IF YOU NOTICE AN ODOR AFTER SWITCHING THE POWER SWITCH ON, PUSH THE SWITCH OFF AND CHECK YOUR WIRING FOR POSSIBLE ERRORS.
4. NEVER MAKE A DIRECT CONNECTION BETWEEN THE POSITIVE (+) POWER SUPPLY POINTS ALONG THE TOP OF THE BREADBOARD AND THE GROUND POINTS ALONG THE BOTTOM.
5. THE THREE POTENTIOMETERS (POTS) HAVE BUILT-IN SERIES RESISTORS TO LIMIT (REDUCE) CURRENT. WHEN USING THE LOOSE LIGHT-EMITTING DIODES (LEDS), ALWAYS INCLUDE A SERIES RESISTOR OF AT LEAST 470 OHMS. SEE ANY PROJECT THAT USES AN LED.
6. BEFORE USING THE 4011 DIGITAL LOGIC CHIP AND THE POWER FIELD-EFFECT TRANSISTOR PROVIDED WITH YOUR SENSORS LAB, REMOVE ANY STATIC CHARGE ON YOUR BODY BY TOUCHING A METAL PIPE, LARGE METAL OBJECT OR SCREW ON A LIGHT SWITCH PLATE.
7. NEVER PULL ON THE WIRES OF THE REMOTE LINK WHEN REMOVING ITS PLUG FROM THE CONSOLE SENSOR SOCKET OR WHEN REMOVING A SENSOR CARD FROM THE REMOTE LINK SOCKET. ONE OR BOTH WIRES MAY COME LOOSE.
8. STORE THE SENSOR CARDS AND LOOSE PARTS PROVIDED WITH YOUR SENSORS LAB IN THE CONSOLE BAY. THE INTEGRATED CIRCUITS AND THE POWER FET TRANSISTOR SHOULD ALWAYS BE STORED IN THE CONDUCTIVE PLASTIC FOAM IN WHICH THEY WERE SHIPPED. WHILE BUILDING CIRCUITS, YOU CAN TEMPORARILY STORE PARTS YOU ARE USING BY INSERTING THEM INTO AN UNUSED PORTION OF THE BREADBOARD. BE SURE THAT NO COMPONENTS OR WIRES FROM YOUR CIRCUITS ARE PLUGGED INTO HOLES THAT LEAD TO UNUSED PARTS.
9. THE LED BARGRAPH READOUT CONSUMES MORE POWER THAN MOST OF THE CIRCUITS THAT YOU WILL BUILD. BE SURE TO PUSH THE DISPLAY MODE SWITCH TO THE OFF POSITION WHEN THE READOUT IS NOT BEING USED.

BATTERY INSTALLATION AND CARE

YOUR SENSORS LAB REQUIRES ONE 9-VOLT BATTERY. REMOVE THE BATTERY COVER ON THE BOTTOM OF THE CONSOLE, SNAP THE BATTERY CONNECTOR ONTO THE BATTERY TERMINALS AND REPLACE THE COVER.

A FRESH BATTERY WILL PROVIDE MANY HOURS OF OPERATION. WHEN THE BATTERY BECOMES WEAK, THE LED READOUT AND SOME OF THE PROJECTS WILL NOT WORK PROPERLY. BE SURE TO REPLACE THE BATTERY WHEN YOU NOTICE THESE SYMPTOMS.

BE SURE TO REMOVE THE 9-VOLT BATTERY IF YOU PLAN TO STORE YOUR ELECTRONIC SENSORS LAB CONSOLE FOR AN EXTENDED PERIOD OF TIME.

FREQUENTLY ASKED QUESTIONS

1. "DO I HAVE TO BUILD THE PROJECTS IN THE ORDER THEY ARE GIVEN?"

NO. BUT IF YOU ARE NEW TO ELECTRONICS, OR IF THIS IS YOUR FIRST LAB KIT, BE SURE TO READ THE INTRODUCTORY PAGES THAT FOLLOW AND TO BUILD THE EXAMPLE CIRCUIT ON PAGES 18-21 BEFORE GOING FURTHER. YOU WILL THEN KNOW WHAT YOU NEED TO KNOW TO HAVE THE MOST FUN WITH AND TO LEARN THE MOST FROM YOUR SENSORS LAB.

2. "THERE ARE MANY WAYS TO BUILD CIRCUITS. DO I HAVE TO FOLLOW THE CHECK LISTS?"

IF YOU ARE NEW TO ELECTRONICS, YES. WITH A LITTLE EXPERIENCE, YOU WILL SOON BE BUILDING THE CIRCUITS STRAIGHT FROM THE CIRCUIT DIAGRAMS.

3. "WHAT DO I DO WHEN A CIRCUIT DOES NOT WORK?"

IF YOU FOLLOW THE INSTRUCTIONS AND USE REASONABLE CARE, CIRCUITS SHOULD WORK THE FIRST TIME YOU PUSH THE POWER SWITCH ON. WHEN A CIRCUIT DOES NOT WORK, PUSH THE POWER SWITCH OFF AND TURN TO PAGE 22 FOR SOME TROUBLESHOOTING TIPS.

4. "IS IT OK TO MODIFY OR CHANGE THE CIRCUITS IN MY SENSORS LAB MANUAL?"

YES. EVEN AFTER YOU BUILD A CIRCUIT THERE ARE SOME EXTRA PARTS FOR MAKING CHANGES. BUT YOU MUST FOLLOW BASIC ELECTRONIC DESIGN GUIDELINES BEFORE MAKING SUCH CHANGES. OTHERWISE YOU MAY DAMAGE SENSITIVE PARTS LIKE ICs AND TRANSISTORS. IF YOU ARE NEW TO ELECTRONICS, WAIT UNTIL YOU'VE BUILT MOST OR ALL THE PROJECTS IN THIS MANUAL BEFORE MODIFYING CIRCUITS. BY THEN YOU MIGHT BE ABLE TO DESIGN YOUR OWN CIRCUITS.

5. "CAN I USE THE CIRCUITS IN MY SENSORS LAB IN PROJECTS FOR SCHOOL OR AT WORK?"

GENERALLY, YES. BUT SINCE THE AUTHOR AND RADIOSHACK HAVE NO CONTROL OVER WHAT YOU DO WITH YOUR SENSORS LAB, WE ARE NOT RESPONSIBLE FOR ANY ADVERSE CONSEQUENCES. FOR EXAMPLE, YOU SHOULD NEVER USE YOUR SENSORS LAB OR ITS CIRCUITS FOR MEDICAL APPLICATIONS, SAFETY DEVICES, TRAFFIC CONTROLLERS, OR ANY OTHER USE THAT MIGHT SOMEHOW RESULT IN DAMAGE TO PROPERTY OR INJURY TO YOU OR OTHERS.

INSTITUTE OF ELECTRICAL AND ELECTRONICS ENGINEERS (IEEE)

YOU WILL LEARN MUCH AND HAVE LOTS OF FUN AS YOU EXPLORE THE EXCITING WORLD OF SOLID STATE ELECTRONICS WITH YOUR ELECTRONIC SENSORS LAB. YOU MIGHT EVEN THINK ABOUT FORMAL ELECTRONICS TRAINING SOME DAY. IF SO, YOU WILL WANT TO KNOW ABOUT THE INSTITUTE OF ELECTRICAL AND ELECTRONICS ENGINEERS (IEEE), THE WORLD'S LARGEST PROFESSIONAL SOCIETY FOR ELECTRICAL ENGINEERS. YOU CAN FIND IEEE MAGAZINES AND TECHNICAL JOURNALS AT COLLEGE LIBRARIES. YOU CAN LEARN MORE ABOUT THE IEEE BY VISITING ITS WEB SITE (WWW.IEEE.ORG).

MANY IEEE MEMBERS FIRST LEARNED ABOUT ELECTRONICS BY BUILDING CIRCUITS MUCH LIKE THOSE IN YOUR SENSORS LAB. THEY KNOW THAT THEIR WORK INFLUENCES THE LIVES, HEALTH, AND SAFETY OF PEOPLE THROUGHOUT THE WORLD. THEREFORE, IEEE MEMBERS HAVE COMMITTED THEMSELVES TO PRACTICING THE HIGHEST ETHICAL AND PROFESSIONAL CONDUCT. MEMBERS AGREE TO ABIDE BY A CODE OF ETHICS THAT RECOGNIZES THE IMPORTANCE OF HONESTY, INTEGRITY, FAIRNESS, AND SAFETY. I HOPE THESE SAME PRINCIPLES WILL SERVE AS YOUR ETHICAL COMPASS AS YOU EXPLORE THE AMAZING WORLD OF ELECTRONIC SENSORS.

THE CONSOLE ELECTRONIC PARTS

MANY OF THE PARTS PROVIDED WITH YOUR ELECTRONIC SENSORS LAB ARE NOT EASILY INSTALLED ON THE SOLDERLESS BREADBOARD. THESE PARTS ARE INSTALLED ON THE CONSOLE. CONNECTION SPRINGS MAKE THESE PARTS VERY EASY TO USE. COMPARE YOUR SENSORS LAB WITH THE ILLUSTRATION BELOW TO BECOME FAMILIAR WITH ITS MANY PARTS.

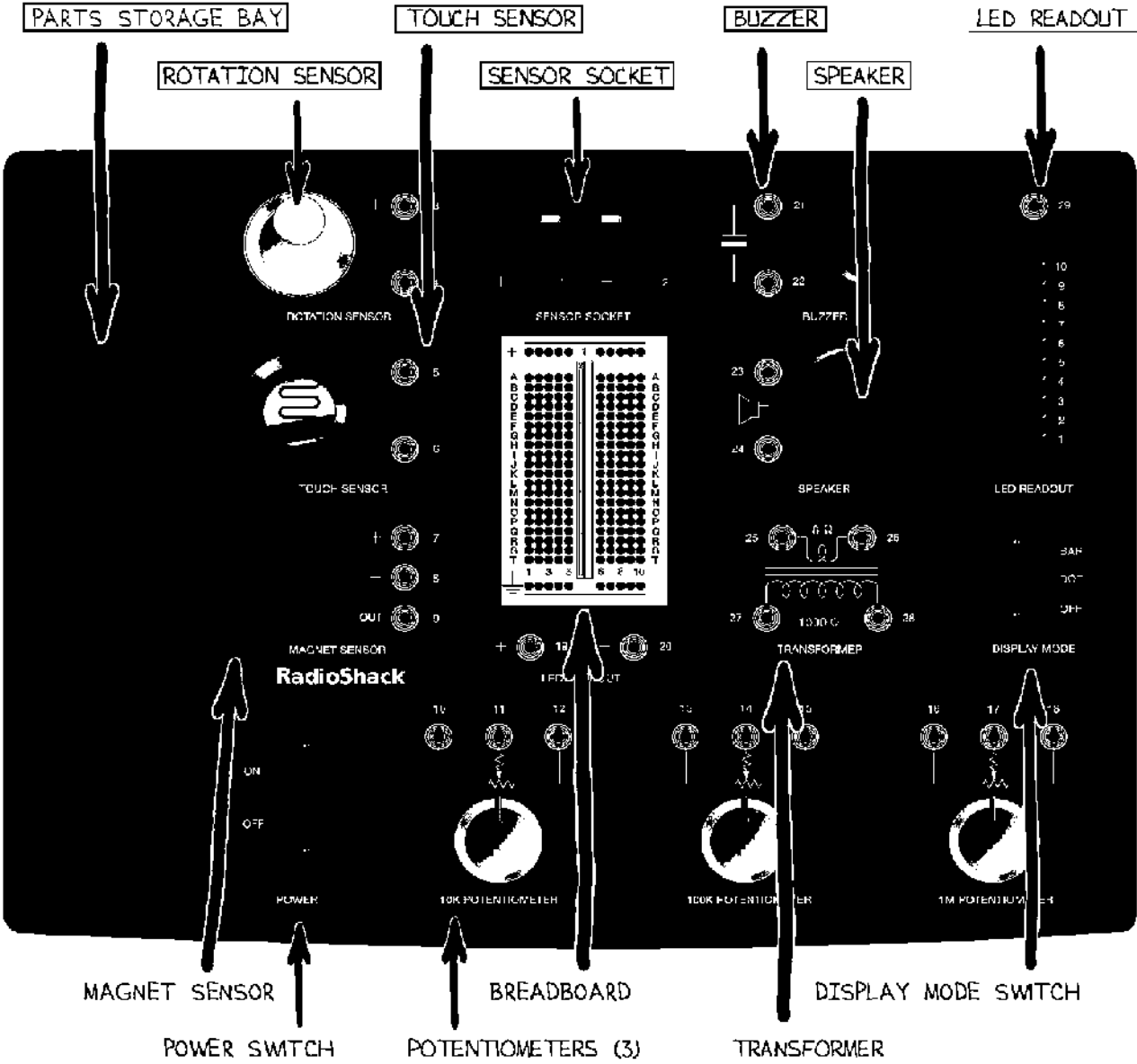

BRIEF EXPLANATIONS FOR THESE PARTS ARE ON THE NEXT PAGE. YOU WILL LEARN MUCH MORE ABOUT EACH PART AS YOU BUILD THE PROJECTS IN THIS MANUAL.

POWER SWITCH

THE POWER SWITCH APPLIES POWER (+9 VOLTS) TO THE BREADBOARD.

ROTATION SENSOR

A SMALL DC MOTOR THAT PRODUCES A VOLTAGE WHEN ROTATED.

TOUCH SENSOR

A PAIR OF INTERLEAVED CONTACTS THAT CAN BE BRIDGED BY A FINGER TIP OR PRESSURE-SENSITIVE CONDUCTIVE FOAM PLASTIC.

MAGNET SENSOR

A SEMICONDUCTOR MAGNET SENSOR KNOWN AS A HALL SENSOR.

SENSOR SOCKET

EXTERNAL SENSORS ARE PLUGGED INTO THE SENSOR SOCKET.

POTENTIOMETERS

POTENTIOMETERS ARE ADJUSTABLE RESISTORS. THREE DIFFERENT RESISTANCE VALUES ARE INSTALLED ON YOUR CONSOLE TO PROVIDE DESIGN FLEXIBILITY. EACH INCLUDES A 470-OHM PROTECTION RESISTOR BETWEEN THE CENTER TERMINAL AND ITS SPRING.

BREADBOARD

YOU WILL BUILD PROJECTS ON THE SOLDERLESS BREADBOARD. IF THE RESISTOR LEADS BEND WHEN YOU FIRST INSERT THEM INTO THE NEW BREADBOARD, LOOSEN THE CONTACT HOLES BY INSERTING A CONNECTION WIRE ONE OR MORE TIMES.

TRANSFORMER

THE TRANSFORMER CONSISTS OF TWO COILS OF WIRE WOUND AROUND A FORM MADE FROM THIN PLATES OF IRON. A SIGNAL FLOWING THROUGH ONE COIL IS INDUCED INTO THE SECOND COIL. CIRCUITS THAT CANNOT BE CONNECTED DIRECTLY TO THE SPEAKER BECAUSE OF THEIR LOW RESISTANCE ARE CONNECTED TO THE SPEAKER THROUGH THE TRANSFORMER.

SPEAKER

THE SPEAKER TRANSFORMS A FLUCTUATING CURRENT INTO SOUND.

BUZZER

THE BUZZER PRODUCES A LOUD TONE AT A FREQUENCY OF ABOUT 2000-2500 HERTZ.

LED READOUT

A 10-LED READOUT THAT INDICATES VOLTAGE BY A MOVING DOT (DOT MODE) OR BY THE HEIGHT OF A COLUMN OF LEDS (BARGRAPH MODE).

DISPLAY MODE SWITCH

SELECTS BETWEEN DOT AND BARGRAPH MODE OF THE LED READOUT.

PARTS SUPPLIED WITH YOUR ELECTRONIC SENSORS LAB

YOUR ELECTRONIC SENSORS LAB IS SUPPLIED WITH A GENEROUS ASSORTMENT OF COMPONENTS. CIRCUIT SYMBOLS AND DRAWINGS OF EACH KIND OF PART ARE GIVEN BELOW. AVOID MISPLACING THE PARTS BY STORING THEM IN THE CONSOLE STORAGE BAY OR IN CONTAINERS OF YOUR CHOICE. BE SURE TO STORE STATIC SENSITIVE PARTS (POWER MOSFETS AND MOST INTEGRATED CIRCUITS) IN THE ORIGINAL PACKAGING OR IN ELECTRICALLY-CONDUCTIVE CONTAINERS. NEVER STORE SUCH PARTS IN PLASTIC BAGS.

CONNECTION WIRES

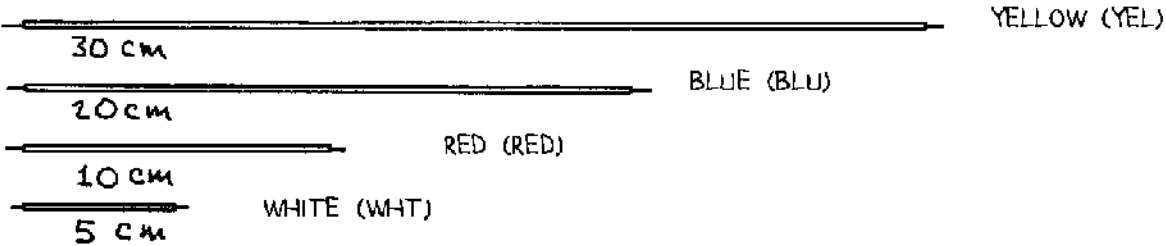

YOUR SENSORS LAB HAS A GENEROUS SELECTION OF CONNECTION WIRES. THE WIRES ARE COLOR-CODED SO THEY CAN BE EASILY REFERRED TO IN THE PROJECT INSTRUCTIONS USING THE ABBREVIATIONS SHOWN HERE.

RESISTORS

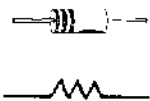

RESISTORS RESIST THE FLOW OF ELECTRICITY. THIS MAKES THEM VERY USEFUL FOR REDUCING CURRENT TO LIGHT-EMITTING DIODES, WHICH CAN BE DAMAGED BY TOO MUCH CURRENT. RESISTORS ARE ALSO USED TO DIVIDE A VOLTAGE INTO A SMALLER VOLTAGE. RESISTORS ARE USED TO INCREASE THE TIME REQUIRED TO CHARGE CAPACITORS AND CONTROL THE DISCHARGE OF CAPACITORS. THEY ARE ALSO USED TO CONTROL THE GAIN OF AMPLIFIERS.

CAPACITORS

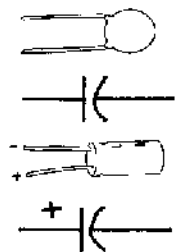

CAPACITORS STORE AN ELECTRICAL CHARGE. CAPACITORS SMOOTH A FLUCTUATING SIGNAL. THEY BLOCK DIRECT (OR CONTINUOUS) CURRENT WHILE PASSING CURRENT PULSES. CAPACITORS IN SERIES WITH RESISTORS ARE USED IN CIRCUITS THAT MEASURE TIME OR GENERATE A SERIES OF PULSES. THEY ARE OFTEN USED WITH RESISTORS. CERAMIC DISK AND ELECTROLYTIC TYPES ARE THE MOST COMMON, WITH THE LATTER HAVING THE MOST CAPACITY.

LIGHT-EMITTING DIODE (LED)

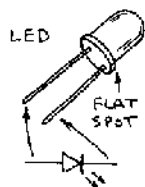

MOST LIGHT-EMITTING DIODES (LEDS) EMIT LIGHT OF ONE COLOR. YOUR SENSORS LAB INCLUDES TWO LOOSE LEDS (RED AND GREEN). THE CATHODE LEAD IS INDICATED BY A FLAT SPOT IN THE RIM AT THE BASE OF EACH DEVICE. A ROW OF 10 RED READOUT LEDS IS INSTALLED IN THE CONSOLE. LEDS MUST USUALLY BE CONNECTED TO A RESISTOR TO REDUCE CURRENT TO A SAFE VALUE. THE CONSOLE LEDS ARE EQUIPPED WITH RESISTORS FOR THIS PURPOSE.

BIPOLAR TRANSISTOR (NPN)



BIPOLAR TRANSISTORS ARE LIKE SWITCHES. CURRENT FLOWING BETWEEN THE COLLECTOR (C) AND EMITTER (E) CAN BE SWITCHED ON OR OFF BY A CURRENT AT THE BASE (B). TRANSISTORS CAN ALSO AMPLIFY BY ALLOWING A TINY, FLUCTUATING SIGNAL AT THE BASE TO CONTROL A MUCH LARGER CURRENT. TRANSISTOR PART NUMBERS ARE PRINTED ON THEIR FRONT SIDE. VARIOUS OTHER NUMBERS MAY ALSO BE PRESENT, SO JUST LOOK FOR THE PART NUMBERS.

POWER FIELD-EFFECT TRANSISTOR (MOSFET)



METAL-OXIDE-SEMICONDUCTOR (MOS) FIELD-EFFECT TRANSISTORS (FETs) ARE EXCELLENT SWITCHES FOR CURRENT FLOWING BETWEEN THE SOURCE (S) AND DRAIN (D). THEY HAVE VERY LITTLE RESISTANCE WHEN TURNED ON BY A VOLTAGE AT THE GATE (G). THIS MEANS THEY CAN CONTROL MUCH MORE CURRENT THAN BIPOLAR TRANSISTORS. THEY CAN ALSO BE USED AS AMPLIFIERS. IMPORTANT: MOSFETS CAN BE DAMAGED BY STATIC ELECTRICITY.

INTEGRATED CIRCUITS (ICs)

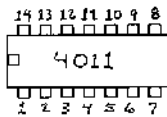

INTEGRATED CIRCUITS (ICs) ARE MICROSCOPIC ELECTRONIC CIRCUITS ETCHED ON A SLIVER OF SILICON CALLED A "CHIP" AND INSTALLED IN A PLASTIC, METAL OR CERAMIC PACKAGE WITH EXTERNAL LEADS OR PINS. AS SHOWN HERE, ONE END OF AN IC HAS AN INDEX MARKER (USUALLY A SMALL CIRCLE OR NOTCH) THAT IDENTIFIES PIN 1.

COMPASS



THE COMPASS IS A LIQUID-FILLED CAPSULE CONTAINING A MINIATURE MAGNET MOUNTED ON A PIVOT POINT. A CIRCULAR DIAL MARKED WITH COMPASS DIRECTIONS IS MOUNTED OVER THE MAGNET. WHEN THE COMPASS IS FLAT, THE MAGNET WILL ALIGN ITSELF WITH THE MAGNETIC FIELD OF THE EARTH OR A NEARBY MAGNET.

MAGNET



THE POWERFUL MAGNET SUPPLIED WITH YOUR ELECTRONIC SENSORS LAB IS MADE FROM METAL ALLOYS. IT IS INSTALLED IN A HOLDER WITH A HOLE FOR A STRING. SLIP ONE END OF THE SUPPLIED STRING THROUGH THE HOLE AND TIE IT IN PLACE. THIS WILL ALLOW YOU TO SWING THE MAGNET LIKE A PENDULUM. CAUTION: THE MAGNET CAN ERASE MAGNETIC COMPUTER DISKS. ALWAYS STORE THE MAGNET IN THE PARTS COMPARTMENT.

PRESSURE SENSOR



A SMALL CYLINDER OF BLACK CONDUCTIVE FOAM PLASTIC ACTS AS A PRESSURE SENSOR WHEN INSERTED INTO THE TOUCH SENSOR OPENING. GENTLE PRESSURE ON THE FOAM PLASTIC IS EASILY DETECTED BY MANY DIFFERENT ELECTRONIC CIRCUITS. THE FLAT PIECE OF BLACK CONDUCTIVE FOAM THAT THE ICs ARE SHIPPED WITH CAN ALSO ACT AS A PRESSURE SENSOR.

ICS PROVIDED WITH YOUR ELECTRONIC SENSORS LAB

THE ICS SUPPLIED WITH YOUR SENSORS LAB ARE INSTALLED IN DUAL-IN-LINE PACKAGES OR "DIPS." EACH HAS AN INDEX MARKER (A SMALL CIRCLE OR A NOTCH) NEAR PIN 1. NUMBERS AND A LOGO OR SYMBOL ARE PRINTED ON EACH DIP. THE PART NUMBER MAY BE ON ANY ROW, AND IT WILL HAVE A PREFIX (MC, LM, TL5, ETC.) AND OTHER CHARACTERS. LOOK AT THE CHIP AT RIGHT. CAN YOU FIND THE PART NUMBER? IT'S 4011. THE OTHER NUMBERS ARE MANUFACTURING AND DATE CODES. IF THE NUMBER IS FAINT, SHINE BRIGHT LIGHT ON THE IC. YOU MAY NEED TO TILT THE IC TO SEE THE NUMBER.

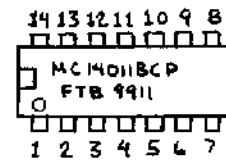

4011 QUAD NAND GATE

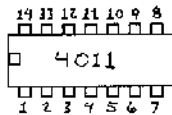

THE 4011 IS A CMOS LOGIC CHIP WITH FOUR INDEPENDENT NAND GATES. YOU WILL USE THE 4011 TO MAKE SIMPLE OSCILLATORS (FOR BUZZES AND MUSICAL TONES) AND PULSE GENERATORS (FOR FLASHING LEDS).

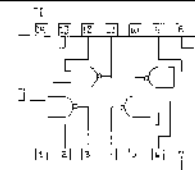

4011 SPECIFICATIONS

SUPPLY VOLTAGE RANGE: +3 VOLTS TO +16 VOLTS.

OUTPUT CURRENT: 10 MILLIAMPERES PER OUTPUT PIN MAXIMUM.

4011 HANDLING PRECAUTIONS

THE 4011 IS A CMOS IC THAT CAN BE EASILY DAMAGED BY STATIC ELECTRICITY. FOLLOW THESE HANDLING PRECAUTIONS WHEN USING THE 4011:

1. BEFORE HANDLING CMOS CHIPS, GROUND YOURSELF TO DRAIN AWAY ANY STATIC ELECTRICAL CHARGE ON YOUR BODY BY TOUCHING A LARGE METAL OBJECT, APPLIANCE OR SCREW ON A LIGHT SWITCH PLATE. THIS IS ESPECIALLY IMPORTANT WHEN THE AIR IS DRY.
2. ALWAYS STORE THE 4011 IN THE BLACK CONDUCTIVE FOAM IN WHICH IT WAS SHIPPED.
3. ALWAYS CONNECT UNUSED 4011 INPUTS TO GROUND OR TO THE POSITIVE SUPPLY VOLTAGE.

555 TIMER (COMBINED ANALOG AND DIGITAL IC)

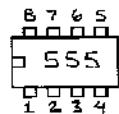

THE 555 (OR NE555) CAN BE USED AS AN OSCILLATOR OR TO PROVIDE PRECISE TIMING DELAYS. BOTH OPERATING MODES CAN BE CONTROLLED BY A SINGLE CAPACITOR OR RESISTOR. THE 555 CAN POWER A SPEAKER OR LED. THE OUTPUT CAN ACT AS A CURRENT SOURCE (OUTPUT DEVICE FROM PIN 3 TO GROUND) OR A SINK (OUTPUT DEVICE FROM POSITIVE SUPPLY TO PIN 3).

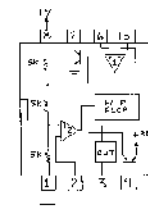

555 SPECIFICATIONS

SUPPLY VOLTAGE RANGE: +4.5 VOLTS TO +16 VOLTS.

SUPPLY CURRENT: 3 MILLIAMPERES TYPICAL.

OUTPUT CURRENT: + OR - 200 MILLIAMPERES MAXIMUM.

272 DUAL-OP AMP

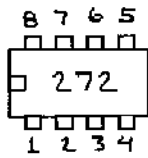

THE 272 (OR TLS272) IS A PACKAGE OF TWO PRECISION OPERATIONAL AMPLIFIERS THAT CAN BE POWERED BY A BATTERY OR OTHER SINGLE-POLARITY SUPPLY. THE TWO OP AMPS ARE INSTALLED IN A SINGLE 8 PIN PACKAGE. THE OUTPUTS OF ALL OP AMPS HAVE A SMALL ERROR VOLTAGE CALLED THE OFFSET. THE 272 OFFSET VOLTAGE IS 1 MILLIVOLT OR LESS WHEN THE GAIN IS 1. BOTH OP AMPS HAVE A VERY HIGH INPUT IMPEDANCE.

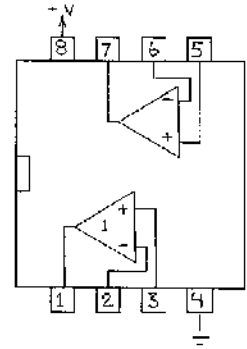

272 SPECIFICATIONS

SUPPLY VOLTAGE RANGE: +3 VOLTS TO +16 VOLTS.

SUPPLY CURRENT: 1.4 MILLIAMPERES TYPICAL (3.2 MA MAXIMUM).

OUTPUT CURRENT: + OR - 30 MILLIAMPERES TYPICAL (10 MA MINIMUM)

MAXIMUM VOLTAGE GAIN: 23,000 TYPICAL (5,000 MINIMUM) AT ROOM TEMPERATURE AND WHEN POWERED BY +5 VOLTS. GAIN IS SET BY A FEEDBACK RESISTOR BETWEEN THE OUTPUT AND THE INVERTING (-) INPUT.

386 AUDIO POWER AMPLIFIER

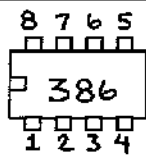

THE 386 (OR LM386) IS A LOW VOLTAGE AMPLIFIER DESIGNED SPECIFICALLY FOR AUDIO APPLICATIONS. THE GAIN IS INTERNALLY SET TO 20. THE GAIN CAN BE INCREASED TO 200 BY CONNECTING A 10-UF CAPACITOR ACROSS PINS 1 (+) AND 8 (-). A RESISTOR IN SERIES WITH THE CAPACITOR CAN REDUCE THE GAIN TO BETWEEN 20 AND 200. THE 386 IS DESIGNED FOR BATTERY OPERATION. IT HAS LOW DISTORTION. APPLICATIONS INCLUDE DRIVING SPEAKERS IN RADIOS, INTERCOMS AND TAPE PLAYERS.

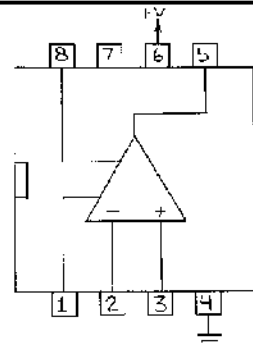

386 SPECIFICATIONS

SUPPLY VOLTAGE RANGE: +4 VOLTS TO +12 VOLTS.

SUPPLY CURRENT (NO INPUT SIGNAL): 4 MILLIAMPERES TYPICAL (8 MA MAXIMUM).

OUTPUT POWER: 325 MILLIWATTS TYPICAL (250 MW MINIMUM) WHEN POWERED BY 6 VOLTS.

VOLTAGE GAIN: 26 DB (20) TYPICAL. 46 DB (200) WITH 10-UF CAPACITOR BETWEEN PINS 1 AND 8.

FREQUENCY BANDWIDTH: 300 KHZ (300,000 HZ) TYPICAL.

TOTAL HARMONIC DISTORTION: 0.2% TYPICAL.

SENSORS SUPPLIED WITH YOUR ELECTRONIC SENSORS LAB

YOUR SENSORS LAB IS PROVIDED WITH A COMPASS AND 10 ELECTRONIC SENSORS. SOME OF THE OTHER PARTS CAN ALSO BE USED AS SENSORS. SIX SENSORS ARE MOUNTED INSIDE PLASTIC CARTRIDGES THAT PLUG INTO THE SENSOR SOCKET ON THE CONSOLE. THESE SENSORS ARE REFERRED TO AS SENSOR CARDS IN THIS WORKBOOK.

COMPASS

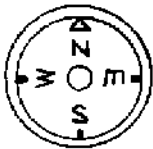

COMPASS

YOU WILL USE THE COMPASS TO DETECT THE MAGNETIC FIELDS OF THE EARTH, THE MAGNET AND MAGNETIZED OBJECTS SUCH AS A PAPER CLIP.

ROTATION SENSOR

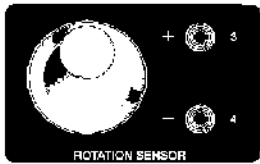

THE CONSOLE ROTATION SENSOR IS A SMALL ELECTRICAL MOTOR THAT ACTS LIKE A GENERATOR WHEN ITS SHAFT IS TURNED. YOU WILL USE THE ROTATION SENSOR TO DETECT ROTATION AND THE DIRECTION OF ROTATION.

TOUCH SENSOR



THE CONSOLE TOUCH SENSOR IS A PAIR OF INTERLEAVED, NON-TOUCHING ELECTRODES. YOU WILL BRIDGE THE ELECTRODES WITH YOUR FINGER TIP TO ACTIVATE VARIOUS CIRCUITS AND PROJECTS. MOISTENING YOUR FINGER TIP WILL ENHANCE THE SENSITIVITY OF THE SENSOR.

PRESSURE SENSOR



THE CONSOLE TOUCH SENSOR BECOMES A SENSITIVE PRESSURE SENSOR WHEN THE SMALL CYLINDER OF BLACK CONDUCTIVE FOAM PLASTIC IS INSERTED IN THE TOUCH SENSOR. YOU WILL APPLY GENTLE PRESSURE TO THE PRESSURE SENSOR TO ACTIVATE VARIOUS CIRCUITS.

MAGNET SENSOR



THE CONSOLE-MOUNTED MAGNET SENSOR IS A SEMICONDUCTOR HALL-EFFECT DEVICE. YOU WILL PLACE THE MAGNET NEAR THE MAGNET SENSOR TO ACTIVATE VARIOUS CIRCUITS AND PROJECTS.

MAGNET SWITCH



THE MAGNET SWITCH IS A NORMALLY-OFF REED SWITCH. YOU WILL PLACE THE MAGNET NEAR THE MAGNET SWITCH TO ACTIVATE THE SWITCH AND CONTROL VARIOUS CIRCUITS AND PROJECTS.

INDUCTION COIL SENSOR



THE INDUCTION COIL SENSOR RESPONDS TO ELECTROMAGNETIC FIELDS. IT CAN BE ATTACHED TO A TELEPHONE RECEIVER USING THE REMOTE LINK AND SUCTION CUP. YOU WILL USE THE SENSOR TO DETECT VARIOUS ELECTROMAGNETIC SOURCES.

PROBE SENSOR



YOU WILL TOUCH THE PROBES OF THIS SENSOR TO VARIOUS MATERIALS, AND YOU WILL INSERT THE PROBES IN WATER TO ACTIVATE TONES AND LEDS.

THERMISTOR SENSOR



THE THERMISTOR SENSOR CONTAINS A TEMPERATURE-SENSITIVE RESISTOR. YOU WILL USE THE THERMISTOR SENSOR CARD TO ACTIVATE TONES AND LEDS WITH TEMPERATURE CHANGES.

PHOTORESISTOR SENSOR



THE PHOTORESISTOR SENSOR CONTAINS A LIGHT-SENSITIVE CADMIUM SULFIDE PHOTORESISTOR. YOU WILL USE THE PHOTORESISTOR SENSOR CARD TO DETECT VERY LOW LEVELS OF LIGHT AND TO CONTROL TONES AND LEDS.

PHOTOTRANSISTOR SENSOR



THE PHOTOTRANSISTOR SENSOR CONTAINS A LIGHT-SENSITIVE SILICON PHOTOTRANSISTOR. YOU WILL USE THE PHOTOTRANSISTOR SENSOR CARD TO DETECT VERY LOW LEVELS OF LIGHT AND TO CONTROL TONES AND LEDS.

REMOTE LINK



THE REMOTE LINK ALLOWS YOU TO USE THE SENSOR CARDS AWAY FROM THE CONSOLE. ONE END OF THE LINK IS INSERTED INTO THE SENSOR SOCKET. THE SENSOR CARD IS INSERTED INTO THE OTHER END OF THE REMOTE LINK. CAUTION: DO NOT REMOVE THE REMOTE LINK BY PULLING ON ITS WIRES.

THE SOLDERLESS BREADBOARD

ELECTRICAL CONNECTION TO THE PARTS INSTALLED ON YOUR ELECTRONIC SENSORS LAB IS MADE POSSIBLE BY 29 SPRING TERMINALS. SENSOR CARDS ARE PLUGGED INTO THE SENSOR SOCKET. LOOSE PARTS ARE INSTALLED ON THE SOLDERLESS BREADBOARD. THE BREADBOARD HAS 220 CONNECTION POINTS. TEN OF THESE POINTS ARE ALONG THE TOP SIDE OF THE BREADBOARD. THEY EACH PROVIDE 9 VOLTS WHEN THE POWER SWITCH IS PUSHED ON. TEN ADDITIONAL POINTS ALONG THE BOTTOM OF THE BREADBOARD ARE CONNECTED TO THE NEGATIVE (-) SIDE OF THE BATTERY (GROUND). YOU WILL INSERT CONNECTION WIRES AND THE LEADS AND PINS OF ELECTRONIC COMPONENTS INTO THE CONNECTION POINTS. THE BREADBOARD IS PERFECT FOR SIMPLE PROJECTS USING ONLY A FEW PARTS. AND IT IS ESPECIALLY USEFUL FOR MORE COMPLICATED PROJECTS THAT USE INTEGRATED CIRCUITS.

HOW THE BREADBOARD IS ORGANIZED

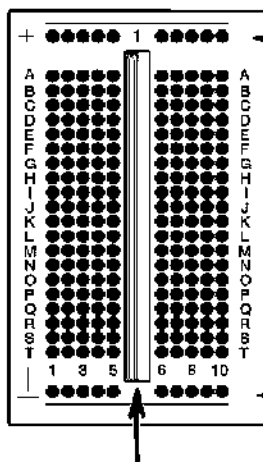

INSERT POSITIVE (+9 VOLT) POWER CONNECTION WIRES IN ANY OF THE 10 HOLES ALONG THE UPPER SIDE OF THE BREADBOARD.

THE MAIN SECTION OF THE BREADBOARD HAS 200 CONNECTION POINTS.

INSERT GROUND CONNECTION WIRES IN ANY OF THE 10 HOLES ALONG THE BOTTOM SIDE OF THE BREADBOARD. POWER IS DELIVERED TO THE BREADBOARD ONLY WHEN THE POWER SWITCH IS PUSHED TO "ON."

THE SLOT THROUGH THE CENTER OF THE BREADBOARD DIVIDES THE CONNECTION POINTS ON THE LEFT FROM THOSE ON THE RIGHT.

HOW THE BREADBOARD COORDINATE SYSTEM WORKS

EACH OF THE 200 CONNECTION POINTS IN THE CENTRAL PORTION OF THE BREADBOARD BETWEEN +9V AND GROUND IS IDENTIFIED BY A COORDINATE SYSTEM BASED ON THE ROW AND COLUMN LABELS. ROWS ARE INDICATED BY LETTERS (A-T) AND COLUMNS BY NUMBERS (1-10). THE ARROWS BELOW SHOW THE LOCATION OF CONNECTION POINT K3.

COLUMN 3

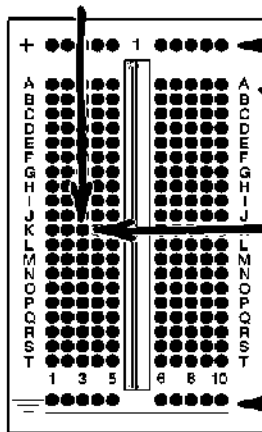

THE PROJECTS IN THIS MANUAL WILL ASK YOU TO CONNECT ONE OR MORE CONNECTION WIRES TO +9 VOLTS (+9V). YOU CAN USE ANY OF THE TEN HOLES ALONG THE TOP OF THE BREADBOARD.

THE FIVE HOLES ON ONE SIDE OF THE BREADBOARD SLOT ARE CONNECTED TOGETHER. THUS ALL FIVE HOLES IN THE ROW A1-A5 ARE CONNECTED TOGETHER, AND THE FIVE HOLES IN ROW A6-A10 ARE CONNECTED TOGETHER. BUT THE HOLES IN A1-A5 AND A6-A10 ARE SEPARATED BY THE SLOT AND ARE NOT CONNECTED TOGETHER.

USE ANY OF THE 10 CONNECTION POINTS ALONG THE BOTTOM OF THE BOARD FOR GROUND.

HOW TO ASSEMBLE CIRCUITS

ELECTRICAL CONNECTION TO THE PARTS INSTALLED ON YOUR ELECTRONIC SENSORS LAB IS MADE POSSIBLE BY 29 SPRING TERMINALS. YOU WILL INSERT THE LOOSE PARTS PROVIDED WITH YOUR SENSORS LAB INTO THE SOLDERLESS BREADBOARD. YOU WILL USE CONNECTION WIRES TO CONNECT THE SPRINGS TO THE PARTS YOU INSTALL ON THE BREADBOARD.

INSERTING CONNECTION WIRES INTO THE SPRINGS

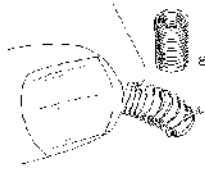

TO INSERT A CONNECTION WIRE INTO A SPRING, BEND THE SPRING SIDWAYS AND INSERT THE EXPOSED METAL PORTION OF THE WIRE INTO AN OPEN SLOT NEAR THE BOTTOM OF THE SPRING. BE SURE THAT ONLY THE BARE METAL ENTERS THE SPRING. THEN ALLOW THE SPRING TO RETURN TO ITS NORMAL POSITION. BE SURE TO KEEP THE INSULATED PORTION OF THE WIRE OUTSIDE THE SPRING. REMOVE CONNECTION WIRES BY BENDING THE SPRING AWAY FROM THE WIRE. THEN PULL THE WIRE FREE.

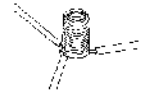

YOU CAN INSERT SEVERAL WIRES INTO A SPRING TERMINAL. FOR BEST RESULTS INSERT WIRES ON OPPOSITE SIDES OF THE TERMINAL. BE SURE TO INSERT NEW WIRES AT DIFFERENT LEVELS WITHIN THE SPRING.

HOW TO INSERT PARTS AND WIRES INTO THE BREADBOARD

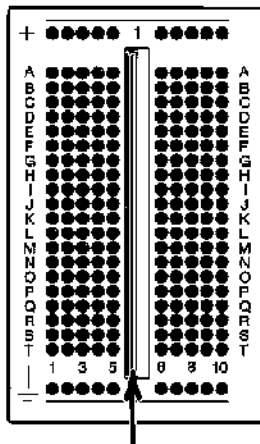

SLOT

INSERT A WIRE INTO A CONNECTION POINT BY PUSHING UNTIL IT STOPS. DO THE SAME WITH PARTS HAVING WIRE LEADS. PARTS WITH THICK LEADS OR PINS, SUCH AS THE TRANSISTOR SHOWN HERE, REQUIRE MORE FORCE. ALIGN THE PINS WITH THE PROPER HOLES AND THEN PRESS DOWN FIRMLY ON THE PART. REMOVE PARTS AND WIRES BY CAREFULLY PULLING THEM STRAIGHT UP. PRY IC'S UP FROM ONE END AND THEN THE OTHER. IF A COMPONENT LEAD DOES NOT SLIP INTO A CONNECTION POINT, INSERT AND REMOVE A CONNECTION WIRE TO OPEN THE CONNECTION.

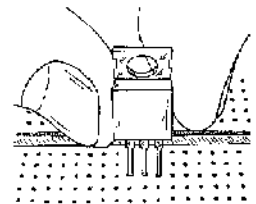

INTEGRATED CIRCUITS (IC'S) MUST BE INSTALLED ACROSS THE SLOT IN THE SOLDERLESS BREADBOARD. THE IC'S SUPPLIED WITH YOUR SENSORS LAB HAVE TWO PARALLEL ROWS OF PINS. EACH ROW SHOULD BE INSERTED INTO THE CONNECTION POINTS ALONG OPPOSITE SIDES OF THE SLOT. USE CARE TO AVOID BENDING PINS. CAUTION: IC PINS ARE SHARP!

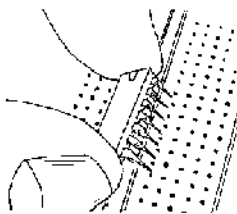

INSTALL AN IC BY LINING UP THE PINS ON ONE SIDE WITH THE CORRECT CONNECTION HOLES ALONG THE EDGE OF THE SLOT. REST THE OPPOSITE SIDE OF THE IC OVER THE PROPER HOLES ON THE OPPOSITE SIDE OF THE SLOT AND PRESS DOWN ON THE TOP OF THE IC. IF THE IC IS NEW, THE PINS ARE SPREAD SLIGHTLY OUTWARD. PRESS THE TIP OF A BALLPOINT PEN NEXT TO THE PIN FARTHEST AWAY FROM YOU. PUSH THE PEN TOWARD THE ROW OF CONNECTION HOLES WHILE PULLING IT ALONG THE ROW OF PINS. AT THE SAME TIME, PRESS DOWN ON THE IC. WHEN THE PEN REACHES THE LAST PIN, THE IC SLIPS INTO THE CONNECTION POINTS AND RESTS FLAT AGAINST THE BREADBOARD.

MORE ABOUT ASSEMBLY METHODS

ALWAYS PUSH THE POWER SWITCH TO OFF BEFORE YOU ASSEMBLE A CIRCUIT. BE SURE TO INSTALL PARTS IN THE PROPER HOLES. A MISTAKE MIGHT ZAP A COMPONENT WHEN YOU APPLY POWER. AN INCORRECTLY INSTALLED PART MAY NOT BE DAMAGED, BUT THE CIRCUIT WILL PROBABLY NOT WORK PROPERLY UNTIL THE ERROR IS CORRECTED.

THESE TWO RESISTORS ARE INSTALLED CORRECTLY

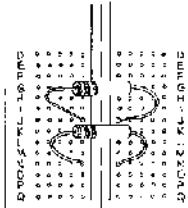

BE SURE TO KEEP THE LEADS OF PARTS FROM TOUCHING ONE ANOTHER WHEN THEY ARE INSTALLED ON THE SOLDERLESS BREADBOARD. THESE TWO RESISTORS ARE INSERTED INTO THE BREADBOARD VERTICALLY. THEIR LEADS ARE SEPARATED FROM ONE ANOTHER AND DO NOT TOUCH.

THESE TWO RESISTORS ARE INSTALLED INCORRECTLY

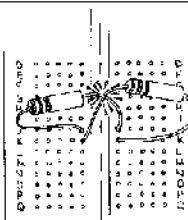

THESE TWO RESISTORS ARE INSTALLED IMPROPERLY. THE ONE ON THE LEFT IS PUSHED DOWN AND ONE OF ITS LEADS IS TOUCHING THE LEAD OF THE ADJACENT RESISTOR. THE CIRCUIT THEY ARE INSTALLED IN WILL NOT WORK PROPERLY—IF IT WORKS AT ALL.

WHAT'S RIGHT ABOUT THIS SAMPLE SOLDERLESS BREADBOARD CIRCUIT?

THIS RESISTOR IS INSTALLED ACROSS THE SLOT IN THE BREADBOARD, WHICH MEANS EACH LEAD GOES TO A SEPARATE CONNECTION ROW. OK.

THIS LED IS INSTALLED ACROSS SEPARATE CONNECTION ROWS. ONE ROW GOES TO A RESISTOR THAT LIMITS CURRENT TO THE LED. THE OTHER ROW GOES TO PIN 3 OF THE INTEGRATED CIRCUIT. GOOD.

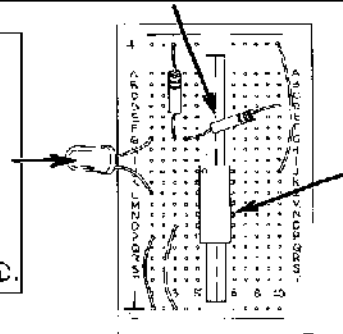

THIS INTEGRATED CIRCUIT IS INSTALLED ACROSS THE SLOT IN THE BREADBOARD. THIS MEANS EACH OF ITS PINS IS INSERTED INTO AN INDEPENDENT CONNECTION ROW. EACH OF THE PINS ON THE IC ENTERS A CONNECTION HOLE AND NONE ARE BENT UNDER THE IC PACKAGE. CORRECT.

WHAT'S WRONG WITH THIS SOLDERLESS BREADBOARD CIRCUIT?

BOTH LEADS OF THIS LED ARE INSTALLED IN THE SAME CONNECTION ROW, THE LED WILL NOT WORK.

BOTH ENDS OF THIS WIRE ARE CONNECTED TO ROWS THAT ARE NOT CONNECTED TO A PART.

BOTH LEADS OF THIS RESISTOR ARE IN THE SAME CONNECTION ROW. THE RESISTOR WILL NOT WORK.

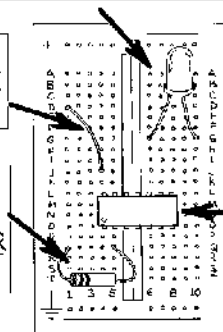













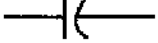
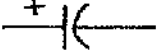
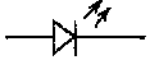

THIS INTEGRATED CIRCUIT IS INCORRECTLY INSTALLED ACROSS THE SLOT IN THE BREADBOARD. THE IC PINS DO NOT GO TO SEPARATE CONNECTION ROWS. AND TWO PINS ON EACH SIDE OF THE IC ARE BENT UNDER THE IC. THE IC MUST BE INSTALLED WITH ITS LONG SIDE PARALLEL WITH THE SLOT.

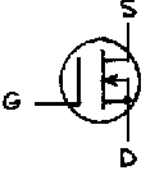
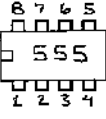
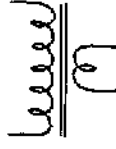
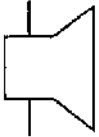
ELECTRONIC CIRCUIT SYMBOLS AND DIAGRAMS

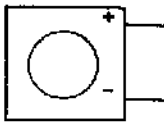
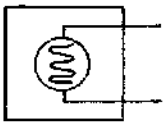
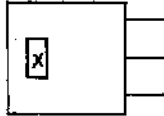
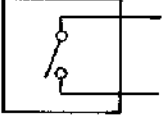
ON PAGES 8-9, VARIOUS SYMBOLS ARE SHOWN ALONGSIDE SOME OF THE THE COMPONENTS THEY REPRESENT. THOSE AND ADDITIONAL CIRCUIT SYMBOLS ARE SHOWN HERE. ON PAGE 18 WE WILL USE SOME OF THESE SYMBOLS TO REPRESENT A CIRCUIT THAT FLASHES A LED.

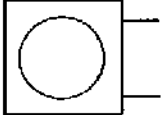
SCHEMATIC OR CIRCUIT DIAGRAM SYMBOLS

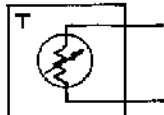
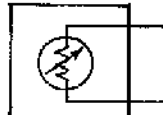
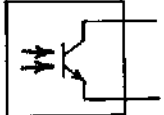
 CONNECTED WIRES	 UNCONNECTED WIRES	 POSITIVE (+) VOLTAGE CONNECTION	 GROUND CONNECTION	 RESISTOR
 POTENTIOMETER	 CERAMIC CAPACITOR	 ELECTROLYTIC CAPACITOR	 LIGHT-EMITTING DIODE (LED)	 NPN BIPOLAR TRANSISTOR
 POWER MOSFET TRANSISTOR	 INTEGRATED CIRCUIT	 TRANSFORMER	 MAGNETIC SPEAKER	 PIEZOELECTRIC BUZZER
 CONSOLE ROTATION SENSOR	 CONSOLE TOUCH SENSOR	 CONSOLE MAGNET SENSOR	 MAGNET SWITCH SENSOR CARD	 MAGNET
 INDUCTION COIL SENSOR CARD	 PROBE SENSOR CARD	 THERMISTOR SENSOR CARD	 PHOTORESISTOR SENSOR CARD	 PHOTO-TRANSISTOR SENSOR CARD

A PICTORIAL VIEW OF A TOUCH-SENSITIVE LED FLASHER

THE ILLUSTRATION BELOW IS A PICTORIAL VIEW OF A CIRCUIT THAT USES A 555 INTEGRATED CIRCUIT TO SEND PULSES OF CURRENT TO A LIGHT-EMITTING DIODE. PICTORIAL VIEWS ARE VERY CLEAR, BUT THEY ARE NOT PRACTICAL FOR COMPLICATED CIRCUITS. CIRCUIT DIAGRAMS OR SCHEMATICS IN WHICH ELECTRONIC PARTS ARE REPRESENTED BY SYMBOLS ARE MUCH MORE COMMONLY USED.

RESISTOR R2 LIMITS CURRENT TO THE LED. 470 OHMS WORKS WITH A RED OR GREEN LED.

THE LEAD NEAR THE LED FLAT SPOT MUST GO TO PIN 3 OF THE 555.

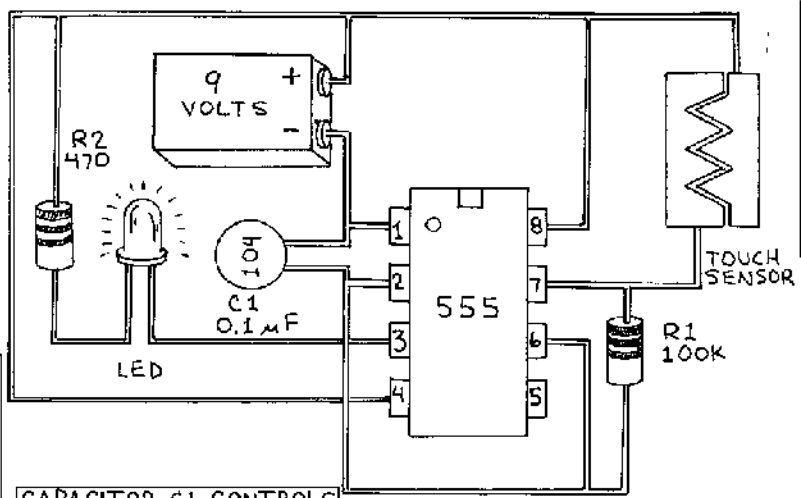

RESISTOR R1 AND THE RESISTANCE OF YOUR FINGER ACROSS THE TOUCH SENSOR CONTROL TIMING AND DURATION OF FLASHES.

CAPACITOR C1 CONTROLS TIMING AND DURATION OF THE FLASHES.

A CIRCUIT DIAGRAM OF A TOUCH-SENSITIVE LED FLASHER

THE CIRCUIT DIAGRAM BELOW IS EQUIVALENT TO THE PICTORIAL VIEW ABOVE. THE SAME CIRCUIT IS SHOWN IN BOTH DIAGRAMS. THE MOST IMPORTANT DIFFERENCE BETWEEN THE TWO DRAWINGS IS THAT IN THE CIRCUIT DIAGRAM THE PINS OF THE 555 IC ARE NOT SHOWN IN THE SAME ARRANGEMENT THEY HAVE ON THE ACTUAL IC. THIS SHORTCUT PROVIDES A SIMPLER WAY OF REPRESENTING THE CIRCUIT.

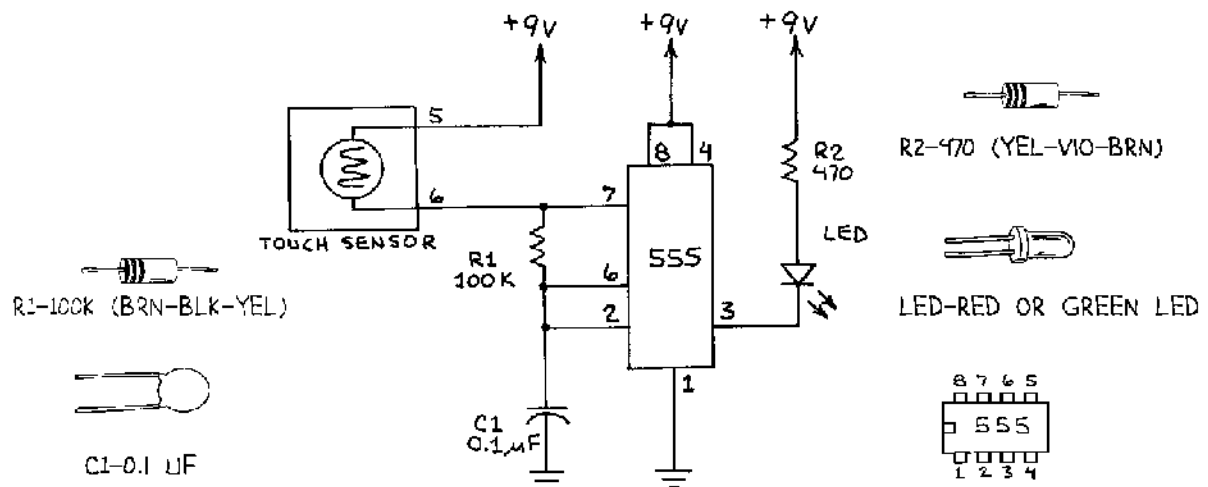

COMPARE THE TWO CIRCUITS BY CHECKING TO SEE IF THE SAME CONNECTIONS ARE MADE TO EACH 555 PIN. START AT PIN 1. (PIN 5 IS NOT USED.) THIS IS AN EXCELLENT WAY TO FIND MISTAKES WHEN YOU BUILD CIRCUITS ON YOUR SENSOR LAB'S BREADBOARD. THE RESISTORS ARE MARKED WITH A CODE OF COLORED BANDS (YEL = YELLOW, VIO = VIOLET, BRN = BROWN, AND BLK = BLACK). THE INSIDE FRONT COVER EXPLAINS HOW TO INTERPRET THIS CODE.

BUILD AN LED FLASHER THAT RESPONDS TO TOUCH

NOW YOU ARE READY TO BUILD THE TOUCH-SENSITIVE LED FLASHER ON PAGE 18. BUILDING THIS CIRCUIT WILL GIVE YOU THE EXPERIENCE YOU WILL NEED TO ASSEMBLE THE PROJECTS DESCRIBED IN THIS MANUAL. **TIP:** CIRCUIT BUILDING GOES MUCH FASTER WHEN YOU FIRST COLLECT ALL THE PARTS YOU WILL NEED. ALSO, BE SURE TO REMOVE ALL UNUSED PARTS AND WIRES FROM THE BREADBOARD BEFORE BEGINNING.

PARTS YOU WILL NEED

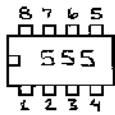

R1-100K (BRN-BLK-YEL)
R2-470 (YEL-VIO-BRN)

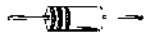

C1-0.1 uF (104)



RED OR GREEN LED

CIRCUIT DIAGRAM

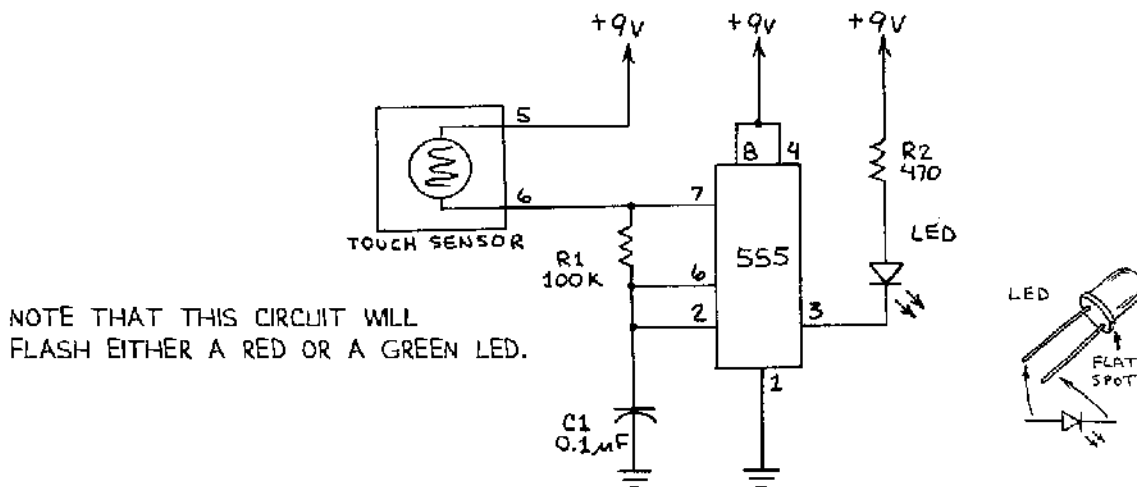

1. BUILD THE CIRCUIT

1. PUSH POWER AND DISPLAY MODE SWITCHES OFF.
2. INSERT THE 555 ACROSS SLOT (PIN 1 AT J5).
3. INSERT R1 ACROSS K10 AND L10.
4. INSERT R2 ACROSS G3 AND +9V.
5. INSERT C1 ACROSS J1 AND K1.
6. INSERT LED ACROSS G1 (ANODE) AND L1 (CATHODE).
7. CONNECT J3 TO GROUND (WHT).
8. CONNECT J10 TO +9V (WHT).
9. CONNECT K4 TO L7 (WHT).
10. CONNECT M4 TO J7 (WHT).
11. CONNECT SPRING 5 TO +9V (RED).
12. CONNECT SPRING 6 TO K7 (RED).

2. TEST THE CIRCUIT

CHECK YOUR WIRING FOR ERRORS. BE SURE THE 555 IC AND THE LED ARE INSTALLED IN THE CORRECT DIRECTION. WHEN YOU ARE SURE EVERYTHING IS CORRECT, PUSH THE POWER SWITCH ON. PRESS THE TOUCH SENSOR, AND THE LED BEGINS TO FLASH. THE FLASH RATE INCREASES AS YOU PRESS HARDER. PROBLEM? SEE PAGES 20 AND 22 FOR HELP.

3. GOING FURTHER

THIS CIRCUIT WILL ALSO RESPOND TO LIGHT. PUSH THE POWER SWITCH OFF. FIND THE SENSOR CARD MARKED "PHOTORESISTOR" AND INSERT IT INTO THE SENSOR SOCKET. MOVE THE RED WIRE AT SPRING 5 TO SPRING 1. MOVE THE RED WIRE AT SPRING 6 TO SPRING 2. PLACE THE CONSOLE IN A DARKENED ROOM AND PUSH THE POWER SWITCH ON. THE LED FLASHES. IF THE LED GLOWS STEADILY, SHIELD IT FROM LIGHT. SLIGHTLY INCREASING THE LIGHT AT THE PHOTORESISTOR INCREASES THE FLASH RATE.

GETTING STARTED: CHECKING OUT THE CIRCUIT

THE CIRCUIT ON PAGE 19 THAT YOU HAVE BUILT SHOULD NOW BE WORKING. WHETHER IT IS OR NOT, COMPARE YOUR CIRCUIT WITH THE ONE BELOW TO SEE WHAT YOU DID RIGHT OR WHAT YOU DID WRONG.

FINDING AND CORRECTING ERRORS IN ELECTRONIC CIRCUITS IS CALLED "TROUBLESHOOTING." TROUBLESHOOTING IS COVERED ON PAGE 22. YOU WILL GET A GOOD IDEA OF WHAT IS INVOLVED IN TROUBLESHOOTING YOUR ELECTRONIC SENSORS LAB PROJECTS BY COMPARING YOUR CIRCUIT WITH THE ILLUSTRATION BELOW.

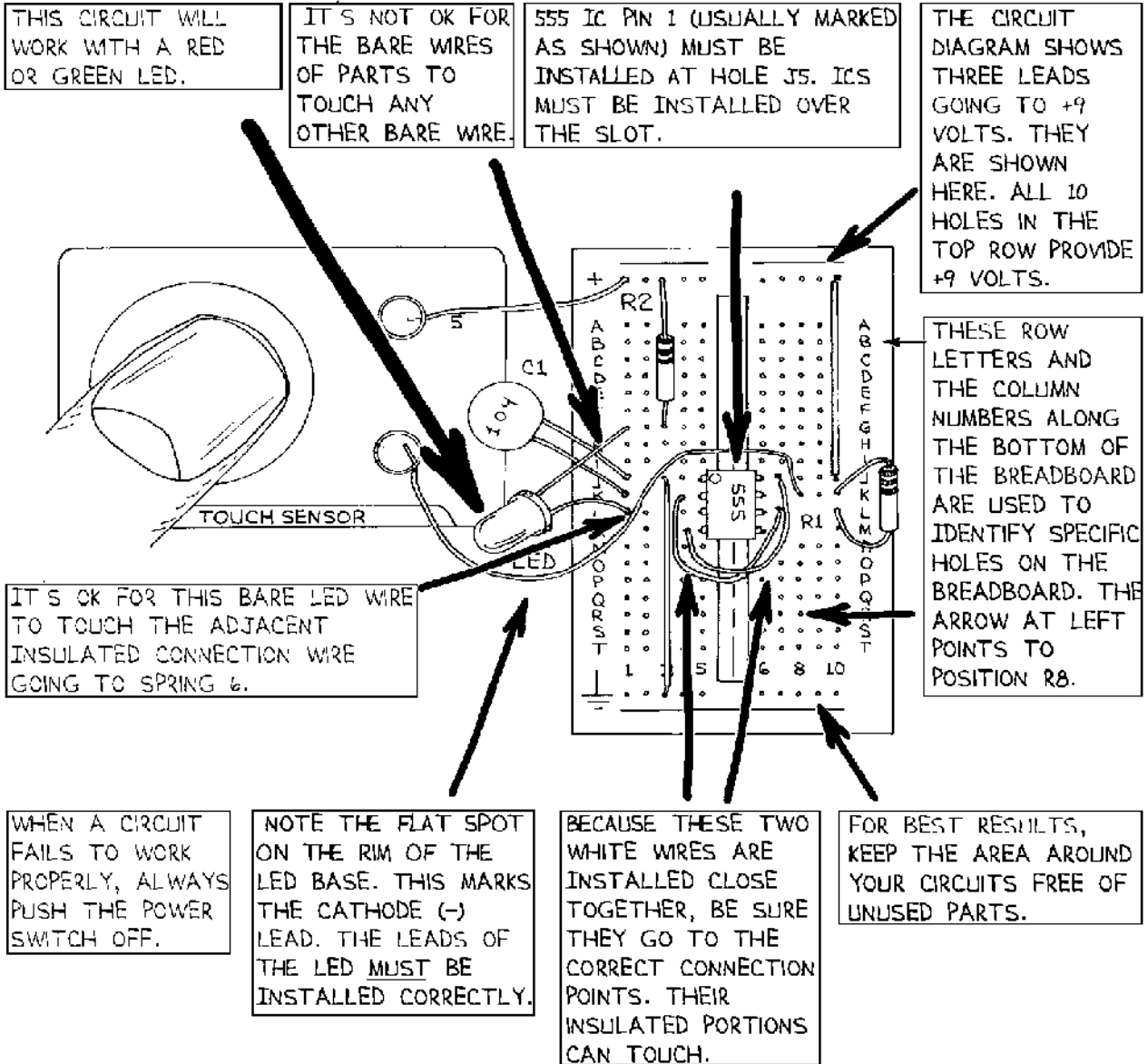

TO PROTECT YOUR SENSORS LAB, AND FOR BEST RESULTS, ALWAYS SWITCH THE POWER SWITCH TO OFF BEFORE BUILDING OR MODIFYING A CIRCUIT. AFTER YOU BUILD A CIRCUIT, CAREFULLY CHECK FOR ERRORS BEFORE SWITCHING THE POWER BACK ON.

GETTING STARTED: REVIEW WHAT YOU HAVE LEARNED

YOU CAN BUILD THE CIRCUITS IN THIS MANUAL IN ORDER OR RANDOMLY. SO YOU CAN QUICKLY LEARN HOW THE PROJECTS ARE PRESENTED, BEGIN WITH THE 555 LED FLASHER ON PAGE 19. THE EXPLANATIONS BELOW SHOW HOW THIS AND MOST OTHER PROJECT PAGES IN THIS MANUAL ARE ORGANIZED. WHILE DETAILED ASSEMBLY INSTRUCTIONS ARE PROVIDED WITH EACH PROJECT, EVENTUALLY YOU WILL BE ABLE TO BUILD THE CIRCUITS STRAIGHT FROM THE CIRCUIT DIAGRAMS. **TIP: BE SURE TO COLLECT ALL THE PARTS BEFORE STARTING A CIRCUIT.**

EACH PROJECT PAGE HAS A TITLE BAR THAT DESCRIBES THE PROJECT. A BRIEF INTRODUCTION BELOW THE TITLE BAR EXPLAINS WHAT YOU WILL DO AND LEARN.

"PARTS YOU WILL NEED" LISTS ALL PARTS EXCEPT WIRES AND THOSE ON THE CONSOLE.

BUILD AN LED FLASHER THAT RESPONDS TO TOUCH

NOW YOU ARE READY TO BUILD THE TOUCH-SENSITIVE LED FLASHER ON PAGE 19. BUILDING THIS CIRCUIT WILL GIVE YOU THE EXPERIENCE YOU WILL NEED TO ASSEMBLE THE PROJECTS DESCRIBED IN THIS MANUAL. THIS CIRCUIT BUILDING GOES MUCH FASTER WHEN YOU FIRST COLLECT ALL THE PARTS YOU WILL NEED. ALSO, BE SURE TO REMOVE ALL UNUSED PARTS AND WIRES FROM THE BREADBOARD BEFORE BEGINNING.

PARTS YOU WILL NEED

- | | | | | |
|--------------------|--------------------|--------------------|--------------------|--------------------|
| 555
10K
100K | 5K
10K
100K | 555
10K
100K | 555
10K
100K | 555
10K
100K |
| 555
10K
100K | 555
10K
100K | 555
10K
100K | 555
10K
100K | 555
10K
100K |
| 555
10K
100K | 555
10K
100K | 555
10K
100K | 555
10K
100K | 555
10K
100K |

CIRCUIT DIAGRAM

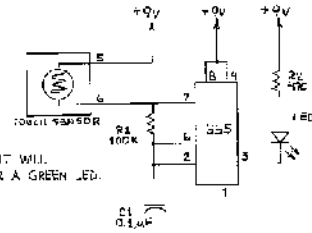

NOTE THAT THIS CIRCUIT WILL FLASH EITHER A RED OR A GREEN LED.

1. BUILD THE CIRCUIT

- | | |
|--|--|
| 1. <input type="checkbox"/> RUSH POWER AND DISPLAY MODE SWITCHES OFF.
2. <input type="checkbox"/> INSERT THE 555 ACROSS SLOT 401 (PIN 1 AT 501).
3. <input type="checkbox"/> INSERT R1 ACROSS R29 AND J3.
4. <input type="checkbox"/> INSERT R2 ACROSS S2 AND 442.
5. <input type="checkbox"/> INSERT C1 ACROSS C1 AND K1.
6. <input type="checkbox"/> INSERT LED ACROSS S1 (ANODE) AND L1 (CATHODE). | 7. <input type="checkbox"/> CONNECT J5 TO GROUND (S421).
8. <input type="checkbox"/> CONNECT J10 TO +9V (S411).
9. <input type="checkbox"/> CONNECT K4 TO L7 (S411).
10. <input type="checkbox"/> CONNECT M1 TO C7 (S411).
11. <input type="checkbox"/> CONNECT SPRING 5 TO +9V (S411).
12. <input type="checkbox"/> CONNECT SPRING 6 TO R2 (S411). |
|--|--|

2. TEST THE CIRCUIT

CHECK YOUR WIRING FOR ERRORS. BE SURE THE 555 IC AND THE LED ARE INSTALLED IN THE CORRECT DIRECTION. WHEN YOU ARE SURE EVERYTHING IS CORRECT, RUSH THE POWER SWITCH ON. PRESS THE TOUCH SENSOR, AND THE LED BEGINS TO FLASH. THE FLASH RATE INCREASES AS YOU PRESS HARDER. PROBLEMS? SEE PAGES 20 AND 22 FOR HELP.

3. GOING FURTHER

THIS CIRCUIT WILL ALSO RESPOND TO LIGHT. PUSH THE POWER SWITCH OFF. FIND THE SENSOR CARD MARKED "PHOTORESISTOR" AND INSERT IT INTO THE SENSOR SOCKET. MOVE THE RED WIRE AT SPRING 5 TO SPRING 1. MOVE THE RED WIRE AT SPRING 6 TO SPRING 2. PLACE THE CONSOLE IN A DARKENED ROOM AND PUSH THE POWER SWITCH ON. THE LED FLASHER. THE LED GLOWS STEADILY. SHIELD IT FROM LIGHT. SLIGHTLY INCREASING THE LIGHT AT THE PHOTORESISTOR INCREASES THE FLASH RATE.

"CIRCUIT DIAGRAM" IS A SCHEMATIC DIAGRAM OF THE CIRCUIT YOU WILL BUILD.

PARTS THAT MUST BE INSTALLED IN A SPECIFIC DIRECTION ARE ILLUSTRATED.

TEST THE "CIRCUIT" REMINDS YOU TO REVIEW YOUR WIRING FOR ERRORS BEFORE PUSHING THE POWER SWITCH ON.

WHEN THERE IS SPACE, "GOING FURTHER" DESCRIBES WAYS TO MODIFY THE CIRCUIT.

"BUILD THE CIRCUIT" GIVES STEP-BY-STEP INSTRUCTIONS. THE FIRST STEP IS ALWAYS THE SAME: SWITCH OFF THE POWER. EVENTUALLY YOU WILL BE ABLE TO BUILD THE CIRCUITS BY FOLLOWING THE CIRCUIT DIAGRAM.

CONNECTION WIRES ARE ABBREVIATED TO SAVE SPACE:

 WHI = WHITE
 RED = RED
 BLU = BLUE
 YEL = YELLOW

THIS GENERAL PAGE LAYOUT IS USED TO PRESENT THE PROJECTS IN THIS MANUAL. WHEN YOU BUILD A PROJECT, YOU MIGHT WANT TO WRITE IN THE MARGINS ANY IDEAS AND TIPS THAT YOU WILL WANT TO REMEMBER SHOULD YOU REVISIT THE PROJECT AT A LATER DATE. BE SURE TO CHECK EACH STEP WHEN YOU BUILD THE CIRCUIT.

TROUBLESHOOTING PROBLEM CIRCUITS

YOUR CIRCUITS SHOULD WORK THE FIRST TIME YOU PUSH THE POWER SWITCH ON IF YOU FOLLOW THE STEP-BY-STEP INSTRUCTIONS, USE THE CORRECT PARTS, AND DON'T BECOME RUSHED. BUT SOMETIMES A CIRCUIT WILL NOT WORK PROPERLY. WHILE THIS CAN BE FRUSTRATING, IT'S A ROUTINE PART OF EXPERIMENTING WITH ELECTRONIC CIRCUITS. HERE'S HOW TO TROUBLESHOOT A PROBLEM CIRCUIT:

1. PUSH THE POWER SWITCH TO THE OFF POSITION.
2. BE SURE A 9-VOLT BATTERY IS INSTALLED IN THE CONSOLE. CHECK TO MAKE SURE IT IS INSTALLED PROPERLY AND THAT IT IS FRESH.
3. BE SURE THAT EXPOSED WIRE LEADS DO NOT TOUCH ONE ANOTHER.
4. THE WIRE CONNECTION LEADS CAN SOMETIMES WORK LOOSE. BE SURE ALL THE LEADS ARE FULLY INSERTED INTO THE BREADBOARD HOLES.
5. CHECK TO MAKE SURE YOU DIDN'T LEAVE OUT A PART OR WIRE. (THIS WON'T HAPPEN IF YOU COLLECT ALL THE PARTS BEFORE YOU BUILD THE CIRCUIT.)
6. MAKE SURE YOU INSTALLED THE CORRECT PARTS. DOUBLE CHECK PART NUMBERS AND RESISTOR COLOR CODES (RED CAN LOOK LIKE ORANGE). IF THE NUMBERS ON TRANSISTORS AND ICs ARE HARD TO READ, HOLD THE PART UNDER A BRIGHT LIGHT.
7. ELECTROLYTIC CAPACITORS, LEDS, TRANSISTORS AND INTEGRATED CIRCUITS MUST BE INSTALLED WITH THE LEADS OR PINS IN A SPECIFIC DIRECTION. BE SURE NONE OF THESE PARTS ARE INSTALLED BACKWARDS.
8. ALL UNUSED INPUTS (NOT OUTPUTS) OF THE 4011 MUST BE CONNECTED TO GROUND OR THE POSITIVE POWER SUPPLY (+ VOLTAGE). A CIRCUIT MAY WORK IF YOU DON'T DO THIS. BUT UNCONNECTED INPUTS ACT LIKE TINY ANTENNAS THAT CAN SWITCH LOGIC CHIPS OFF AND ON. THIS CAN CAUSE ERRATIC OPERATION AND EXCESSIVE CURRENT DRAIN.
9. FREQUENTLY USED MECHANICAL PARTS, LIKE THE CONSOLE SWITCHES AND POTENTIOMETERS, TEND TO FAIL BEFORE COMPONENTS WITHOUT MOVING PARTS. IF A CIRCUIT DOESN'T RESPOND WHEN YOU TURN THE KNOB OF A POTENTIOMETER, TRY BYPASSING THE POTENTIOMETER WITH TWO RESISTORS.
10. IF YOU TOOK SHORTCUTS OR MADE CHANGES TO A CIRCUIT, TRY REBUILDING THE CIRCUIT EXACTLY AS SHOWN IN THE CIRCUIT DIAGRAM. MAKE CHANGES TO PROJECTS ONLY AFTER THE CIRCUIT IS WORKING.
11. IF THE CIRCUIT STILL FAILS TO WORK, CHECK THE CONNECTIONS OF EACH PIN OR LEAD AGAINST THE CIRCUIT DIAGRAM. IF THE CIRCUIT USES AN IC, CHECK THE CONNECTIONS TO EACH PIN. BEGIN AT PIN 1 AND WORK AROUND THE CHIP PIN BY PIN. YOU WILL QUICKLY FIND MISSING OR INCORRECTLY INSTALLED WIRES AND PARTS.
12. SOMETIMES YOU CAN FIX A CIRCUIT FASTER BY REBUILDING IT THAN BY TRYING TO FIND A WIRING ERROR. AS A LAST RESORT, REMOVE ALL THE WIRES AND PARTS. MAKE SURE ALL THE PARTS ARE THE CORRECT ONES AND START OVER. IF THE CIRCUIT STILL FAILS, A PART MAY BE BAD. TRY USING A SUSPECT TRANSISTOR OR IC IN A DIFFERENT CIRCUIT. IF THAT CIRCUIT FAILS TO WORK, THE TRANSISTOR OR IC MAY BE BAD.

MORE ABOUT SENSORS

THE CONSOLE OF YOUR ELECTRONIC SENSORS LAB HAS THREE SENSORS FOR DETECTING ROTATION, TOUCH AND MAGNETISM. ADDING A SMALL CYLINDER OF CONDUCTIVE FOAM PLASTIC CONVERTS THE TOUCH SENSOR TO A PRESSURE SENSOR.

YOUR SENSORS LAB COMES WITH SIX PLUG-IN SENSOR CARDS. ONE CARD IS A PROBE FOR DETECTING RESISTANCE CHANGES CAUSED BY WATER AND EVEN YOUR SKIN. THERE ARE TWO CARDS FOR DETECTING LIGHT AND ONE FOR DETECTING TEMPERATURE. THERE IS A CARD FOR DETECTING ELECTROMAGNETIC FIELDS AND A MAGNET SWITCH CARD. THE COMPASS PROVIDED WITH YOUR SENSORS LAB IS ALSO A SENSOR. SO YOUR SENSORS LAB HAS A TOTAL OF 11 SENSORS.

ACTUALLY THERE ARE MORE SENSORS THAN THESE. BEFORE MOVING ON TO THE PROJECTS, LET'S LOOK AT HOW MANY OF THE PARTS PROVIDED WITH YOUR SENSORS LAB CAN DOUBLE AS SENSORS.

POTENTIOMETER SENSOR: THE CONSOLE OF YOUR SENSORS LAB HAS THREE POTENTIOMETERS. THESE VARIABLE RESISTORS HAVE MANY USES AS SENSORS. HANG A ROD WITH A WEIGHT ON ONE END FROM THE SHAFT OF A POTENTIOMETER AND YOU HAVE A SENSOR THAT CHANGES ITS RESISTANCE IN RESPONSE TO ACCELERATION OR DECELERATION. IF YOU MAKE THE ROD LONG ENOUGH, THE POTENTIOMETER BECOMES A SEISMOMETER THAT WILL CHANGE RESISTANCE WHEN THE EARTH MOVES DURING AN EARTHQUAKE. POTENTIOMETERS ARE ALSO VERY USEFUL POSITION AND ROTATION SENSORS.

SPEAKER SENSOR: THE SPEAKER ON YOUR CONSOLE CAN ALSO FUNCTION AS A SENSOR. NORMALLY A SPEAKER EMITS SOUND. A SPEAKER WILL ALSO GENERATE A SMALL VOLTAGE IN RESPONSE TO SOUND.

LED READOUT SENSOR: THE LED READOUT DOUBLES AS A VERY SENSITIVE RESISTANCE SENSOR. YOU CAN SEE HOW BY PUSHING THE POWER SWITCH TO ON AND THE DISPLAY MODE SWITCH TO DOT. NOW BRIDGE YOUR INDEX FINGER ACROSS SPRINGS 19 AND 20 WHILE WATCHING THE LED READOUT. THE MOVING DOT WILL MOVE DOWN WHEN YOU PRESS YOUR FINGER ON THE TWO SPRINGS. PRESS A BIT HARDER, AND THE MOVING DOT WILL MOVE DOWN MORE. THE LED READOUT IS ALSO AN EFFECTIVE VOLTAGE SENSOR. TRY THIS EXPERIMENT:

1. PUSH THE POWER SWITCH TO OFF.
2. CONNECT SPRING 13 TO +9V (BLU).
3. CONNECT SPRING 15 TO GROUND (RED).
4. CONNECT SPRINGS 14 AND 19 (RED).

ROTATE THE KNOB OF THE 100K POTENTIOMETER ALL THE WAY TO THE RIGHT. THEN ROTATE THE 100K POTENTIOMETER TO THE LEFT WHILE WATCHING THE LED READOUT. EVENTUALLY A MOVING LED WILL TRACK THE MOVEMENT OF THE POTENTIOMETER KNOB. SINCE THE CENTER SPRING OF THE POTENTIOMETER IS PROVIDING A VARIABLE VOLTAGE TO THE READOUT WHEN YOU TURN THE KNOB, THIS EXPERIMENT SHOWS HOW THE READOUT ACTS LIKE A VOLTAGE SENSOR. THIS ALSO SHOWS HOW THE POTENTIOMETER ACTS LIKE A POSITION SENSOR.

TRANSISTOR, LED AND SWITCH SENSORS: THE NPN TRANSISTOR PROVIDED WITH YOUR SENSORS LAB CAN BE USED AS A TEMPERATURE SENSOR. THE RED AND GREEN LEDs CAN BE USED AS SENSORS THAT DETECT RED AND GREEN LIGHT. EVEN THE POWER SWITCH CAN BE CONSIDERED A SIMPLE POSITION SENSOR.

AS YOU CAN SEE, MANY DIFFERENT ELECTRONIC PARTS CAN DOUBLE AS SENSORS.

USE A COMPASS TO DETECT MAGNETIC FIELDS

YOU WILL USE THE COMPASS TO DETECT THE MAGNETIC FIELD OF EARTH AND A MAGNET, AND MAGNETIZE THE WIRE LEAD OF AN LED, USING THE COMPASS TO VERIFY IT IS MAGNETIZED.

PARTS YOU WILL NEED



COMPASS



RED OR GREEN LED

1. DETECT THE EARTH'S MAGNETIC FIELD

PLACE THE COMPASS ON A FLAT SURFACE AWAY FROM METAL OBJECTS. THE N (NORTH) POINTER OF THE COMPASS POINTS TOWARD THE EARTH'S MAGNETIC NORTH POLE. THE MAGNETIC NORTH POLE IS LOCATED IN NORTH CANADA, NOT AT THE GEOGRAPHIC NORTH POLE. THE ANGULAR DIFFERENCE BETWEEN TRUE NORTH AND MAGNETIC NORTH IS CALLED DECLINATION. DEPENDING ON YOUR LOCATION, DECLINATION CAN RANGE FROM A FRACTION OF A DEGREE TO MORE THAN 20 DEGREES. TOPOGRAPHIC MAPS USUALLY INCLUDE A DIAGRAM THAT SHOWS BOTH TRUE NORTH AND MAGNETIC NORTH FOR THE REGION COVERED BY THE MAP.

A COMPASS POINTER OR NEEDLE IS A MINIATURE MAGNET. SINCE THE NORTH POLE OF A MAGNET ATTRACTS ONLY THE SOUTH POLE OF ANOTHER MAGNET, HOW CAN THE NORTH POLE OF A COMPASS BE ATTRACTED TO EARTH'S MAGNETIC NORTH POLE? IT IS MORE CORRECT TO SAY THE END OF THE COMPASS POINTER THAT POINTS NORTH IS ACTUALLY THE NORTH SEEKING END OF THE COMPASS. BY CUSTOM, THE END OF A MAGNET THAT ATTRACTS THE NORTH POLE OF A COMPASS IS DEFINED AS THE MAGNET'S SOUTH POLE.

2. DETECT A MAGNET'S MAGNETIC FIELD

PLACE THE MAGNET ON ITS RIM ON A FLAT SURFACE. PLACE THE COMPASS ON THE SAME SURFACE ABOUT 7 CM (ABOUT 2.75 INCHES) FROM THE MAGNET'S SOUTH POLE. THE NORTH POLE OF THE COMPASS POINTS TOWARD THE SOUTH POLE OF THE MAGNET. MOVE THE COMPASS IN A CIRCLE WITH THE MAGNET AT ITS CENTER. WHEN THE COMPASS IS ALIGNED WITH THE EDGES OF THE MAGNET, IT POINTS EITHER EAST OR WEST. WHEN THE COMPASS IS NEAREST THE NORTH POLE OF THE MAGNET, THE SOUTH POLE OF THE COMPASS POINTS TOWARD THE MAGNET. BE SURE TO KEEP THE MAGNET FROM TOUCHING THE COMPASS. THIS MAY CAUSE THE NORTH AND SOUTH POLES OF THE COMPASS TO BECOME REVERSED. IF THIS OCCURS, TRY PLACING THE COMPASS ON TOP OF THE SOUTH SIDE OF THE MAGNET TO REMAGNETIZE THE COMPASS POINTER IN THE PROPER DIRECTION.

3. MAGNETIZE THE WIRE LEADS OF A LED

HOLD THE LED'S WIRE LEADS NEAR THE COMPASS. THE COMPASS POINTER SHOULD NOT BE DEFLECTED. RUB THE EXPOSED SURFACE OF THE MAGNET (NORTH POLE) AGAINST THE TWO LED LEADS 20 TIMES. RUB FROM THE DIRECTION OF THE EPOXY PACKAGE THAT HOLDS THE LED TO THE END OF THE WIRE LEAD. RUB 20 TIMES IN THIS DIRECTION AND ALONG THE FULL LENGTH OF THE LEAD. HOLD THE ENDS OF THE TWO LEADS NEAR THE COMPASS. THEY ATTRACT THE SOUTH END OF THE COMPASS POINTER. REPEAT THIS PROCEDURE, RUBBING THE OPPOSITE SIDE OF THE MAGNET (SOUTH POLE) AGAINST THE LED LEADS. NOW WHEN YOU HOLD THE LEAD ENDS NEAR THE COMPASS, THEY ATTRACT THE NORTH END OF THE COMPASS POINTER. THIS PROCESS IS COMPLETELY REVERSIBLE. PROVE THIS BY AGAIN STROKING THE SOUTH POLE OF THE MAGNET AGAINST THE WIRE LEADS. THIS EXPERIMENT WORKS WITH MANY DIFFERENT STEEL OBJECTS. IF YOU RUB A PAPER CLIP FROM THE CENTER TO ONE END, ONLY THAT HALF OF THE PAPER CLIP IS MAGNETIZED. THAT END OF THE PAPER CLIP ATTRACTS THE COMPASS POINTER, BUT THE OPPOSITE END MAY NOT.

USE A COMPASS TO DETECT AN ELECTROMAGNETIC FIELD

YOU WILL MAKE A SIMPLE COIL. YOU WILL PLACE A PAPER CLIP INSIDE THE COIL, THEN DISCHARGE A CAPACITOR THROUGH THE COIL. THE RAPID SURGE OF CURRENT THROUGH THE COIL CREATES AN ELECTROMAGNETIC FIELD THAT MAGNETIZES THE STEEL PAPER CLIP INSIDE THE COIL. THE PAPER CLIP THEN ATTRACTS THE POINTER OF A NEARBY COMPASS. THIS PROVES THAT THE PAPER CLIP HAS BEEN MAGNETIZED BY THE FLOW OF ELECTRICAL CURRENT THROUGH THE COIL.

PARTS YOU WILL NEED



COMPASS



R1-1K (BRN-BLK-RED)

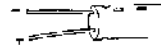

C1-470 uF

PAPER CLIP
YELLOW WIRE

CIRCUIT DIAGRAM

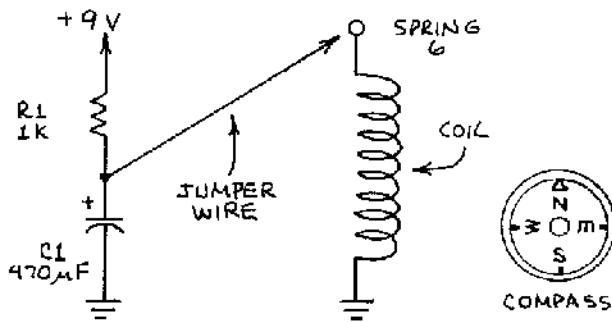

1. MAKE THE COIL

WIND A YELLOW CONNECTION WIRE AROUND A PENCIL. THE COIL WILL HAVE AROUND 8 TURNS. BEND THE EXPOSED WIRES AT EACH END OF THE COIL SO THEY ARE IN LINE AND PROJECT OUTWARD FROM THE COIL.

2. BUILD THE CIRCUIT

1. PUSH POWER AND DISPLAY SWITCHES OFF.
2. INSERT C1 ACROSS R1 (+) AND GROUND (-).
3. INSERT R1 ACROSS K2 AND R2.
4. INSERT THE COIL ACROSS Q5 AND GROUND.
5. CONNECT K1 TO +9V (RED).
6. CONNECT SPRING 6 TO Q1 (RED).
7. INSERT JUMPER WIRE AT R3 (RED).

3. TEST THE CIRCUIT

BE SURE THAT C1 IS INSTALLED IN THE PROPER DIRECTION. THEN SLIDE THE PAPER CLIP INSIDE THE COIL, AND PLACE THE COMPASS NEAR THE END OF THE PAPER CLIP. PUSH THE POWER SWITCH ON. TOUCH THE FREE END OF THE JUMPER WIRE TO SPRING 6. THE COMPASS POINTER WILL IMMEDIATELY RESPOND TO THE MAGNETIC FIELD THAT HAS BEEN GENERATED.

REMOVE THE PAPER CLIP FROM THE COIL AND HOLD ONE END NEAR THE COMPASS. THE NORTH OR SOUTH POINTER OF THE COMPASS WILL BE ATTRACTED TO THE PAPER CLIP. REVERSE THE POSITION OF THE PAPER CLIP, AND THE OPPOSITE POLE OF THE COMPASS WILL BE ATTRACTED.

4. GOING FURTHER

MARK THE END OF THE PAPER CLIP THAT ATTRACTS THE SOUTH POLE OF THE COMPASS. THIS IS THE NORTH POLE OF THE PAPER CLIP. NOW INSERT THE PAPER CLIP BACK INSIDE THE COIL AND REPEAT THE ABOVE EXPERIMENT. WHICH POLE OF THE COMPASS NOW POINTS TO THE MARKED END OF THE PAPER CLIP? REVERSE THE POSITION OF THE PAPER CLIP AND REPEAT THE EXPERIMENT. YOU WILL FIND THAT THE MAGNETIC POLARITY OF THE PAPER CLIP CAN BE EASILY REVERSED USING THE COIL.

USE A MAGNET TO SWITCH ON AN LED

YOU WILL USE THE MAGNET TO SWITCH ON AN LED.

PARTS YOU WILL NEED

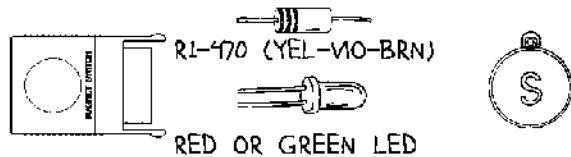

CIRCUIT DIAGRAM

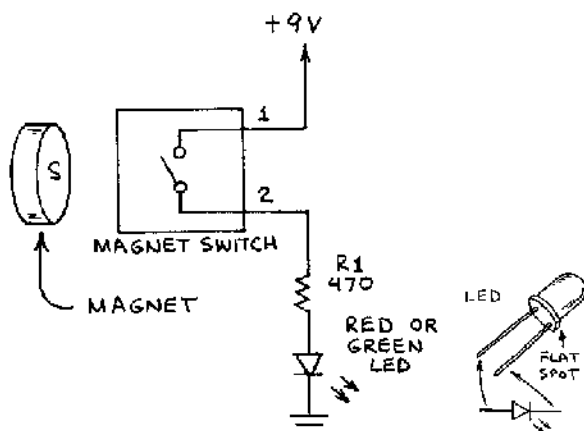

1. BUILD THE CIRCUIT

1. PUSH POWER AND DISPLAY SWITCHES OFF.
2. INSERT MAGNET SWITCH CARD.
3. INSERT R1 ACROSS SPRING 2 AND H10.
4. INSERT LED ACROSS H6 (ANODE) AND J6 (CATHODE).
5. CONNECT J10 TO GROUND (WHT).
6. CONNECT SPRING 1 TO +9V (WHT).

2. TEST THE CIRCUIT

CHECK FOR ERRORS. PUSH THE POWER SWITCH UP, AND THE LED WILL BE OFF. PLACE THE MAGNET NEAR THE MAGNET SWITCH CARD, AND THE LED WILL GLOW. SWING THE MAGNET PAST THE MAGNET SWITCH CARD LIKE A PENDULUM TO FLASH THE LED ON AND OFF.

USE A MAGNET TO ALTER THE BUZZER

USE THE MAGNET TO CAUSE THE BUZZER TO EMIT A TONE THAT DIFFERS FROM NORMAL.

PARTS YOU WILL NEED

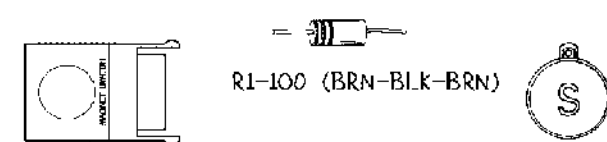

CIRCUIT DIAGRAM

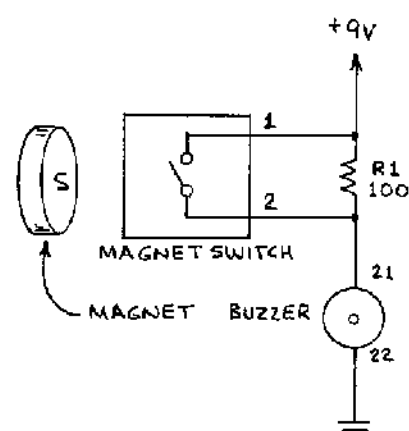

1. BUILD THE CIRCUIT

1. PUSH THE POWER AND DISPLAY SWITCHES OFF.
2. INSERT MAGNET SWITCH CARD.
3. INSERT R1 ACROSS C6 AND +9V.
4. CONNECT SPRING 1 TO +9V (WHT).
5. CONNECT SPRING 2 TO C8 (WHT).
6. CONNECT SPRING 21 TO C10 (RED).
7. CONNECT SPRING 22 TO GROUND (BLU).

2. TEST THE CIRCUIT

CHECK FOR ERRORS. PUSH THE POWER SWITCH UP, AND THE BUZZER WILL SOUND. PLACE THE MAGNET NEAR THE MAGNET SWITCH CARD, AND THE BUZZER'S TONE WILL CHANGE DISTINCTLY. SWING THE MAGNET PAST THE MAGNET SWITCH CARD LIKE A PENDULUM FOR NEAT EFFECTS.

USE A MAGNET TO SWITCH AN LED OFF

YOU WILL USE THE MAGNET TO SWITCH AN LED OFF.

PARTS YOU WILL NEED

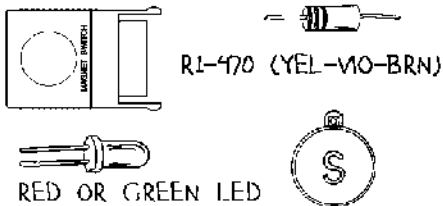

CIRCUIT DIAGRAM

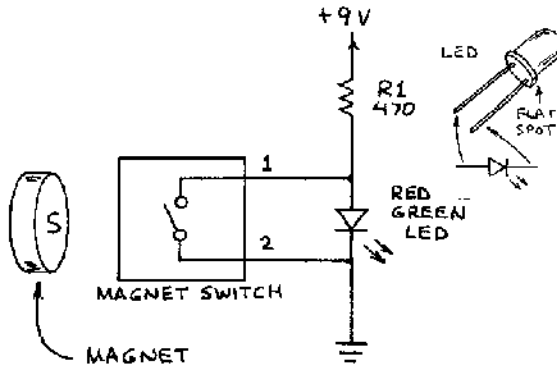

1. BUILD THE CIRCUIT

1. PUSH POWER AND DISPLAY SWITCHES OFF.
2. INSERT MAGNET SWITCH CARD.
3. INSERT R1 ACROSS H5 AND +9V.
4. INSERT LED ACROSS H3 (ANODE) AND L3 (CATHODE).
5. CONNECT L5 TO GROUND (WHT).
6. CONNECT SPRING 1 TO H1 (RED).
7. CONNECT SPRING 2 TO GROUND (BLU).

2. TEST THE CIRCUIT

CHECK FOR ERRORS. PUSH THE POWER SWITCH UP, AND THE LED WILL GLOW. PLACE THE MAGNET NEAR THE MAGNET SWITCH CARD, AND THE LED WILL SWITCH OFF. SWING THE MAGNET BACK AND FORTH BY THE MAGNET SWITCH CARD LIKE A PENDULUM, AND THE LED WILL FLASH OFF AND ON.

USE A MAGNET TO SWITCH THE BUZZER OFF

YOU WILL USE THE MAGNET TO SILENCE THE BUZZER.

PARTS YOU WILL NEED

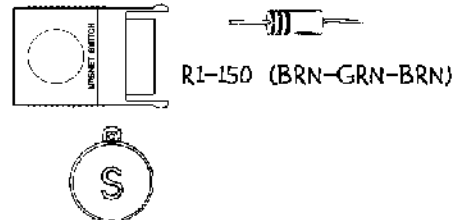

CIRCUIT DIAGRAM

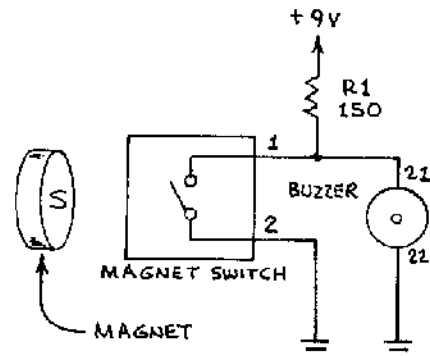

1. BUILD THE CIRCUIT

1. PUSH POWER AND DISPLAY SWITCHES OFF.
2. INSERT MAGNET SWITCH CARD.
3. INSERT R1 ACROSS C3 AND +9V.
4. CONNECT SPRING 1 TO C1 (WHT).
5. CONNECT SPRING 2 TO GROUND (BLU).
6. CONNECT SPRING 21 TO C5 (RED).
7. CONNECT SPRING 22 TO GROUND (BLU).

2. TEST THE CIRCUIT

CHECK FOR ERRORS. PUSH THE POWER SWITCH UP, AND THE BUZZER WILL SOUND. PLACE THE MAGNET NEAR THE MAGNET SWITCH CARD, AND THE BUZZER WILL STOP. SWING THE MAGNET BACK AND FORTH BY THE MAGNET SWITCH CARD, AND THE BUZZER WILL EMIT A SERIES OF PULSES.

BUILD A RED-GREEN MAGNET DETECTOR

YOU WILL BUILD A MAGNET DETECTOR CIRCUIT. IF A MAGNET IS NEAR THE MAGNET SWITCH CARD, THE RED LED GLOWS. OTHERWISE, THE GREEN LED GLOWS.

PARTS YOU WILL NEED

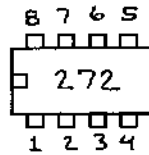
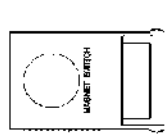

R1, R4, R5-1K (BRN-BLK-RED)
R2, R3-10K (BRN-BLK-ORG)

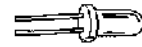

RED LED
GREEN LED



CIRCUIT DIAGRAM

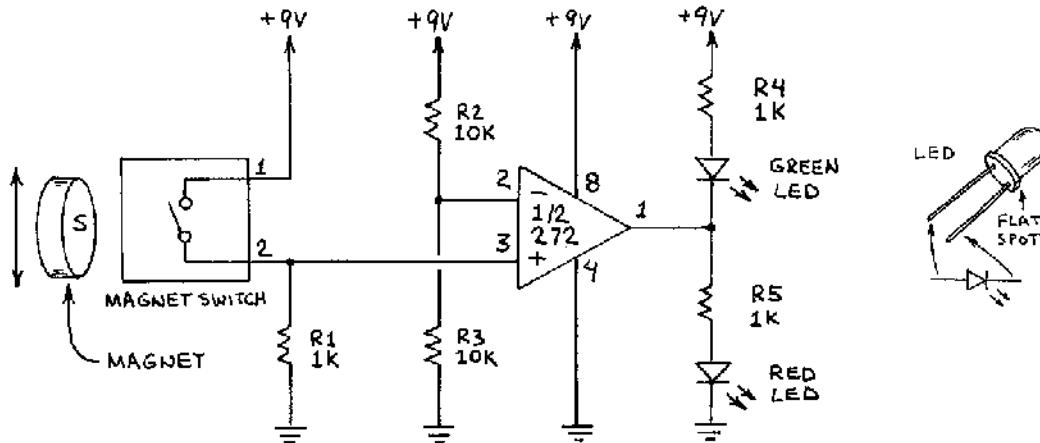

1. BUILD THE CIRCUIT

1. PUSH POWER AND DISPLAY SWITCHES OFF.
2. INSERT MAGNET SWITCH CARD IN THE SENSOR SOCKET.
3. INSERT 272 IC ACROSS SLOT (PIN 1 AT J5).
4. INSERT R1 ACROSS L2 AND M2.
5. INSERT R2 ACROSS K4 AND J7.
6. INSERT R3 ACROSS K1 AND M1.
7. INSERT R4 ACROSS H2 AND +9V.
8. INSERT R5 ACROSS J3 AND T3.
9. INSERT RED LED ACROSS T1 (ANODE) AND GROUND (CATHODE).
10. INSERT GREEN LED ACROSS H1 (ANODE) AND J1 (CATHODE).
11. CONNECT M4 TO GROUND (WHT).
12. CONNECT J10 TO +9V (WHT).
13. CONNECT SPRING 1 TO +9V (WHT).
14. CONNECT SPRING 2 TO L4 (RED).

2. TEST THE CIRCUIT

CHECK THAT THE CIRCUIT IS BUILT CORRECTLY. SPREAD THE RESISTOR LEADS AND GREEN LED OUTWARD SO THEY DO NOT TOUCH. PUSH THE POWER SWITCH ON AND THE GREEN LED GLOWS. PLACE THE MAGNET NEAR THE MAGNET SWITCH CARD. THE GREEN LED DIMS AND THE RED LED GLOWS. LISTEN WHEN YOU PLACE THE MAGNET NEAR THE MAGNET SWITCH CARD. A METALLIC CLICK SOUNDS EACH TIME THE SWITCH RESPONDS TO THE MAGNET.

3. GOING FURTHER

REVISE THE CIRCUIT SO THAT THE GREEN LED IS OFF WHEN THE RED LED IS GLOWING.

1. PUSH POWER AND DISPLAY SWITCHES OFF.
2. REMOVE THE RED LED.
3. MOVE RED WIRE AT L4 TO N5.
4. INSERT RED LED ACROSS N4 (ANODE) AND L4 (CATHODE).

MAKE SURE NONE OF THE LEADS ARE TOUCHING. PUSH THE POWER SWITCH ON. PLACE THE MAGNET NEAR THE MAGNET SWITCH CARD AND THE RED LED GLOWS. NOTE THE GREEN LED IS OFF WHEN THE RED LED IS GLOWING.

BUILD A FERROUS METAL DETECTOR

YOU WILL BUILD A SIMPLE CIRCUIT THAT INDICATES WHEN A FERROUS METAL (STEEL OR IRON) IS PLACED BETWEEN THE MAGNET AND THE MAGNET SWITCH. NORMALLY A RED LED GLOWS. WHEN FERROUS METAL IS PRESENT THE LED SWITCHES OFF.

PARTS YOU WILL NEED

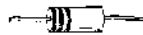
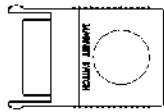

R1-470 (YEL-VIO-BRN)



RED LED



CIRCUIT DIAGRAM

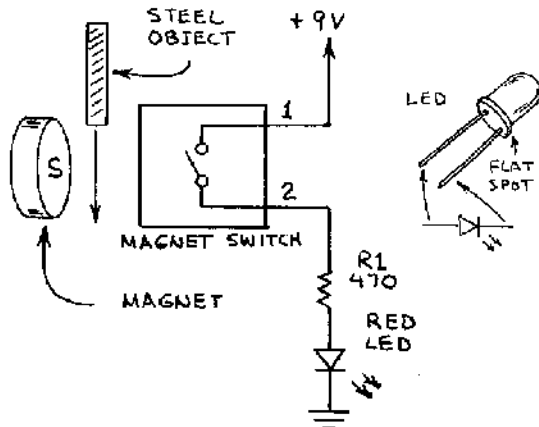

1. BUILD THE CIRCUIT

1. PUSH POWER AND DISPLAY SWITCHES OFF.
2. INSERT MAGNET SWITCH CARD IN THE SENSOR SOCKET.
3. INSERT R1 ACROSS P10 AND T10.
4. INSERT LED ACROSS T6 (ANODE) AND GROUND (CATHODE).
5. CONNECT SPRING 1 TO -9V (WHT).
6. CONNECT SPRING 2 TO P6 (RED).

2. TEST THE CIRCUIT

CHECK YOUR WIRING FOR ERRORS, THEN PUSH THE POWER SWITCH ON. PLACE THE MAGNET NEAR THE MAGNET SWITCH CARD. THE LED GLOWS. FIND A PIECE OF STEEL OR IRON SUCH AS SCISSORS, TWEEZERS, OR A STEEL RULER. HOLD THE MAGNET SO THAT THE LED GLOWS, THEN PLACE THE STEEL OBJECT BETWEEN THE MAGNET AND THE MAGNET SWITCH CARD. THE LED STOPS GLOWING IF THE OBJECT IS STEEL. THIS TEST CAN BE A LITTLE TRICKY, BECAUSE THE MAGNET WANTS TO JUMP TOWARD THE STEEL OBJECT. HOLD BOTH THE MAGNET AND THE STEEL OBJECT FIRMLY IN PLACE TO AVOID THIS FROM HAPPENING. FOR BEST RESULTS, EXPERIMENT WITH THE MAGNET LOCATION. YOU MIGHT FIND THAT THE MAGNET SWITCH RESPONDS BETTER WHEN THE MAGNET IS LOCATED SLIGHTLY TO ONE SIDE RATHER THAN DIRECTLY IN FRONT OR IN BACK OF THE MAGNET SWITCH. YOU CAN ALSO USE THE REMOTE LINK TO MOVE THE MAGNET SWITCH TO A DIFFERENT LOCATION.

REPEAT THIS TEST USING VARIOUS NON-FERROUS MATERIALS, SUCH AS ALUMINUM FOIL, A WOOD OR PLASTIC RULER, AND FABRICS. THE LED STAYS ON WHEN ALL THESE MATERIALS ARE PLACED BETWEEN THE MAGNET AND THE MAGNET SWITCH CARD. THESE TESTS ARE EASY TO DO SINCE THE MAGNET IS NOT ATTRACTED TO NON-FERROUS OBJECTS.

3. GOING FURTHER

THIS PROJECT CAN BE USED TO MAKE A VERY SENSITIVE MOVEMENT OR VIBRATION DETECTOR. A STEEL RULER MAKES A GOOD FERROUS OBJECT. MOUNT THE RULER ON A FIXED OBJECT, AND PLACE THE CONSOLE SO THAT THE RULER FACES THE FRONT OR BACK SIDE OF THE MAGNET SWITCH CARD. HOLD THE MAGNET FIRMLY IN PLACE, AND ADJUST THE CONSOLE SO THAT THE RULER COMES BETWEEN THE MAGNET SWITCH AND THE MAGNET. CAREFULLY MOVE THE CONSOLE SO THAT THE LED SWITCHES OFF. NOW A SLIGHT MOVEMENT OF THE RULER OR THE CONSOLE CAUSES THE LED TO GLOW.

BUILD A BUZZER VIBRATION DETECTOR

YOU WILL USE THE MAGNET AND THE MAGNET SWITCH TO ACTIVATE THE BUZZER IN RESPONSE TO VIBRATION.

PARTS YOU WILL NEED

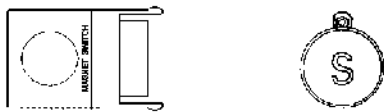

BUILD AN LED VIBRATION DETECTOR

YOU WILL USE THE MAGNET AND THE MAGNET SWITCH TO ACTIVATE AN LED IN RESPONSE TO VIBRATION.

PARTS YOU WILL NEED

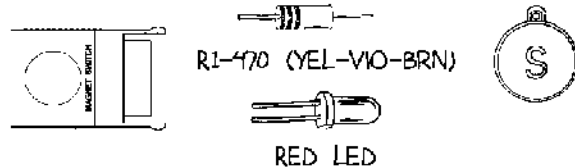

CIRCUIT DIAGRAM

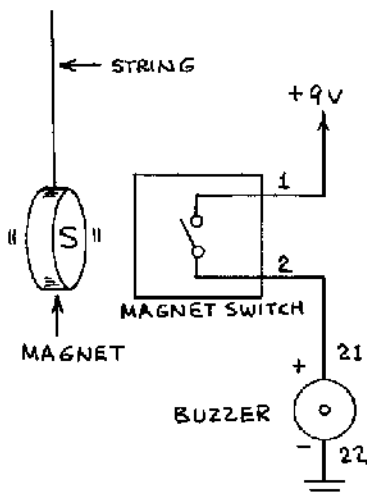

CIRCUIT DIAGRAM

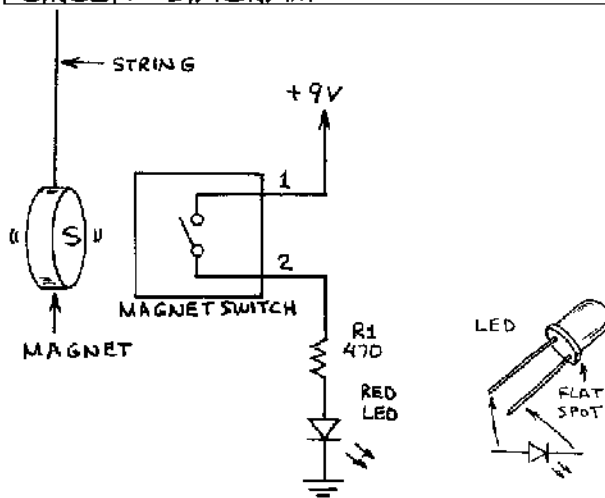

1. BUILD THE CIRCUIT

1. PUSH POWER AND DISPLAY SWITCHES OFF.
2. INSERT MAGNET SWITCH CARD IN THE SENSOR SOCKET.
3. CONNECT SPRING 1 TO +9V (WHT).
4. CONNECT SPRINGS 2 AND 21 (WHT).
5. CONNECT SPRING 22 TO GROUND (BLU).

1. BUILD THE CIRCUIT

1. PUSH POWER AND DISPLAY SWITCHES OFF.
2. INSERT MAGNET SWITCH CARD IN THE SENSOR SOCKET.
3. INSERT R1 ACROSS P10 AND T10.
4. INSERT LED ACROSS T6 (ANODE) AND GROUND (CATHODE).
5. CONNECT SPRING 1 TO +9V (WHT).
6. CONNECT SPRING 2 TO P6 (RED).

2. TEST THE CIRCUITS

CHECK YOUR WIRING FOR ERRORS. PUSH THE POWER SWITCH ON. PLACE THE CONSOLE UNDER A BOOKSHELF OR OTHER STEADY PLACE WHERE YOU CAN HANG THE MAGNET. TIE OR TAPE THE END OF THE MAGNET STRING TO THE OBJECT AND MOVE THE CONSOLE SO THAT THE MAGNET IS NEAR THE MAGNET CARD. WHEN THE BUZZER SOUNDS OR THE LED GLOWS, MOVE THE CONSOLE JUST FAR ENOUGH WAY TO SWITCH IT OFF. THE BUZZER WILL NOW SOUND OR THE LED WILL GLOW WHEN THE SLIGHTEST VIBRATION CAUSES THE MAGNET OR THE CONSOLE TO MOVE.

USE A MAGNET TO BUILD A PENDULUM METRONOME

YOU WILL CONNECT THE MAGNET SWITCH CARD BETWEEN A SIMPLE 555 OSCILLATOR AND THE POWER SUPPLY (+9 VOLTS). YOU WILL THEN SWITCH THE OSCILLATOR ON AND OFF BY SWINGING THE MAGNET PAST THE MAGNET SWITCH CARD TO FORM A PENDULUM METRONOME.

PARTS YOU WILL NEED

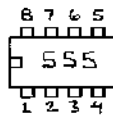
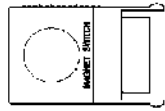

R2-10K (BRN-BLK-ORG)
R3-270 (RED-VIO-BRN)



C1-0.1 UF (104)



CIRCUIT DIAGRAM

THE MAGNET IS STRONGLY ATTRACTED TO THE STEEL SPRINGS ON THE CONSOLE. YOU WILL NEED TO AVOID THE SPRINGS WHEN YOU SWING THE MAGNET.

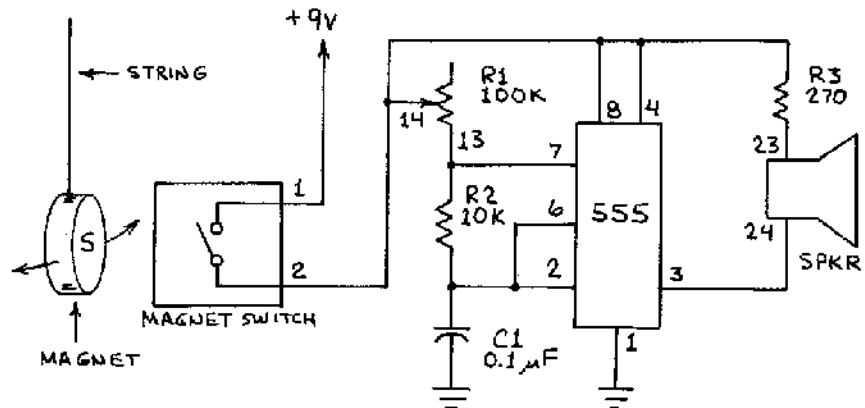

1. BUILD THE CIRCUIT

1. PUSH THE POWER AND DISPLAY SWITCHES OFF.
2. INSERT MAGNET SWITCH CARD IN THE SENSOR SOCKET.
3. INSERT 555 IC ACROSS SLOT (PIN 1 AT Q5).
4. INSERT R2 ACROSS R10 AND S10.
5. INSERT R3 ACROSS SPRING 23 AND A10.
6. INSERT C1 ACROSS Q1 AND R1.
7. CONNECT R4 TO S7 (WHT).
8. CONNECT T4 TO Q7 (WHT).
9. CONNECT Q10 TO A6 (RED).
10. CONNECT SPRING 1 TO +9V (WHT).
11. CONNECT SPRING 2 TO A8 (RED).
12. CONNECT SPRING 13 TO R7 (RED).
13. CONNECT SPRING 14 TO T3 (RED).
14. CONNECT SPRING 24 TO S4 (RED).

2. TEST THE CIRCUIT

CHECK YOUR WIRING FOR ERRORS. HOLD THE MAGNET NEAR THE MAGNET SWITCH CARD AND PUSH THE POWER SWITCH ON. YOU HEAR A TONE. WHILE HOLDING THE MAGNET IN PLACE, ADJUST 100K CONSOLE POT R1 FOR THE BEST SOUND. WHEN YOU MOVE THE MAGNET AWAY FROM THE MAGNET SWITCH CARD, THE TONE CEASES. THE SOUND RETURNS WHEN YOU PLACE THE MAGNET BY THE MAGNET SWITCH CARD. HOLD THE MAGNET BY ITS STRING AND SWING IT BACK AND FORTH PAST THE MAGNET SWITCH CARD. EACH TIME THE MAGNET PASSES THE CARD, THE MAGNET SWITCH IS ACTIVATED AND YOU HEAR A TONE. A SIMILAR EFFECT OCCURS WHEN YOU SWING THE MAGNET TOWARD AND AWAY FROM THE MAGNET SWITCH CARD.

3. GOING FURTHER

YOU CAN CONVERT THE ON-OFF OPERATION OF THIS CIRCUIT INTO A "TWEED-DELL" EFFECT. WHEN THE MAGNET IS AWAY, THE FIRST TONE SOUNDS. WHEN THE MAGNET IS NEAR THE SWITCH CARD, YOU HEAR THE SECOND TONE. YOU NEED R4, A 100K RESISTOR (BRN-BLK-YEL).

1. PUSH POWER AND DISPLAY SWITCHES OFF.
 2. MOVE RED WIRE AT A8 TO J10.
 3. INSERT R4 ACROSS J8 AND R8.
 4. CONNECT A8 TO +9V (WHT).
- REPEAT THE PENDULUM EXPERIMENTS DESCRIBED ABOVE.

HOW TO USE THE ROTATION SENSOR

THE ROTATION SENSOR MOUNTED ON THE CONSOLE OF YOUR ELECTRONIC SENSORS LAB IS A SMALL DC (DIRECT CURRENT) ELECTRIC MOTOR. A KNOB IS CONNECTED TO THE MOTOR'S SHAFT. THE MOTOR WILL PRODUCE ELECTRICITY WHEN YOU MANUALLY SPIN ITS SHAFT. THEREFORE, A DC MOTOR CAN DOUBLE AS A SMALL ELECTRICAL GENERATOR. SINCE THE POLARITY OF THE VOLTAGE AT SPRING 3 IS POSITIVE WHEN THE SHAFT IS SPUN TO THE RIGHT (CLOCKWISE), THE MOTOR CAN SENSE ROTATION. PAGES 33-35 HAVE SOME NEAT APPLICATIONS FOR THE ROTATION SENSOR. FIRST, TRY THESE BASIC CIRCUITS.

BUILD AN AUDIO OUTPUT ROTATION SENSOR

THIS SIMPLE CIRCUIT EMITS CLICKS WHEN THE ROTATION SENSOR SHAFT IS SPUN.

CIRCUIT DIAGRAM

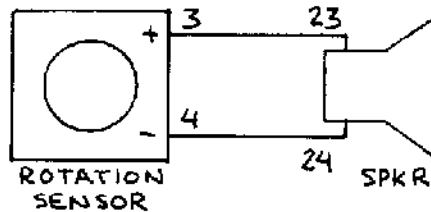

1. BUILD THE CIRCUIT

1. CONNECT SPRINGS 3 AND 23 (BLU).
2. CONNECT SPRINGS 4 AND 24 (BLU).

2. TEST THE CIRCUIT

PLACE YOUR EAR NEAR THE SPEAKER WHILE SPINNING THE ROTATION SENSOR KNOB WITH YOUR INDEX FINGER. YOU WILL HEAR A SERIES OF CLICKS WHEN THE SENSOR IS ROTATED IN EITHER DIRECTION. THE ROTATION SENSOR PRODUCES A POSITIVE VOLTAGE AT SPRING 3 WHEN THE SENSOR IS SPUN TO THE RIGHT. A NEGATIVE VOLTAGE IS PRODUCED WHEN THE SENSOR IS SPUN TO THE LEFT. THE CLICKING SOUNDS ARE THE SAME FOR BOTH DIRECTIONS.

BUILD AN LED OUTPUT ROTATION SENSOR

THIS SIMPLE CIRCUIT FLASHES A GREEN LED WHEN THE ROTATION SENSOR SHAFT IS SPUN.

CIRCUIT DIAGRAM

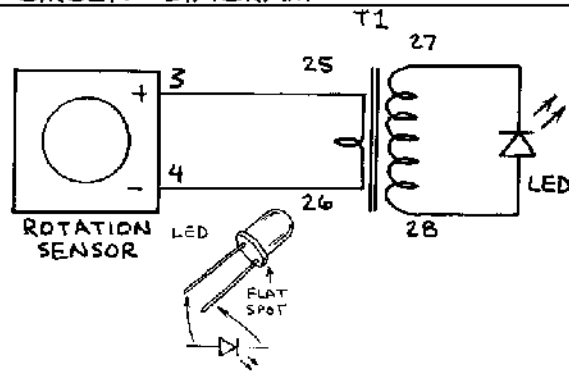

1. BUILD THE CIRCUIT

1. CONNECT SPRINGS 3 AND 25 (BLU).
2. CONNECT SPRINGS 4 AND 26 (BLU).
3. INSERT LED ANODE AT SPRING 28.
4. INSERT LED CATHODE AT SPRING 27.

2. TEST THE CIRCUIT

DIM THE ROOM LIGHTS AT YOUR CONSOLE AND SPIN THE ROTATION SENSOR. THE LED WILL FLASH WHEN YOU SPIN THE SENSOR TO THE LEFT (COUNTER-CLOCKWISE). TRANSFORMER T1 IS USED TO BOOST THE TINY VOLTAGE FROM THE SENSOR TO A LEVEL THAT WILL DRIVE THE LED.

BUILD A DIRECTION OF ROTATION SENSOR

IS A ROBOT TURNING LEFT OR RIGHT? IS A CONVEYOR BELT MOVING IN THE RIGHT DIRECTION OR BACKWARDS? THIS CIRCUIT SHOWS A VERY SIMPLE WAY TO FIND OUT. USE THE ROTATION SENSOR TO BUILD A CIRCUIT THAT LIGHTS A RED LED WHEN THE SENSOR IS ROTATED IN ONE DIRECTION AND A GREEN LED WHEN THE SENSOR IS ROTATED IN THE OPPOSITE DIRECTION.

PARTS YOU WILL NEED

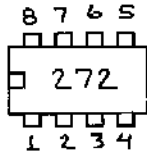

R1-10K (BRN-BLK-ORG)
R2 100 (BRN BLK BRN)
R3, R4-1K (BRN-BLK-RED)

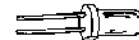

1 RED LED
1 GREEN LED

CIRCUIT DIAGRAM

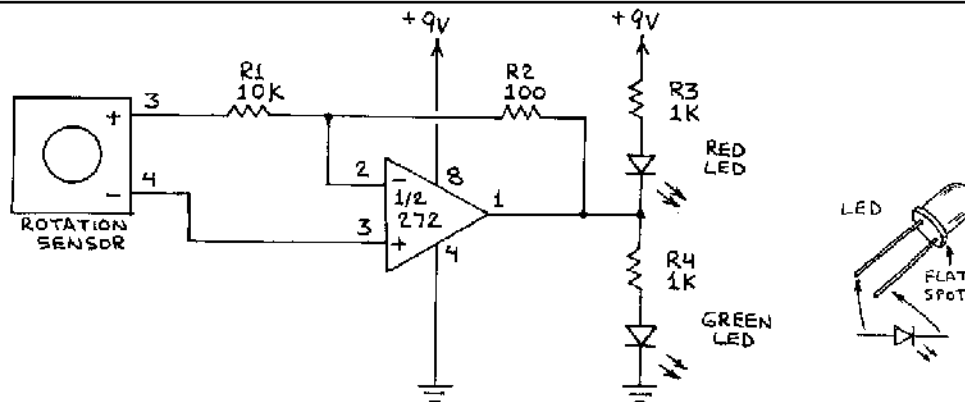

1. BUILD THE CIRCUIT

- PUSH POWER AND DISPLAY SWITCHES OFF.
- INSERT 272 IC ACROSS SLOT (PIN 1 AT J5).
- INSERT R1 ACROSS A4 AND K4.
- INSERT R2 ACROSS J1 AND K1.
- INSERT R3 ACROSS I1 AND +9V
- INSERT R4 ACROSS J3 AND T3.
- INSERT RED LED ACROSS I2 (ANODE) AND J2 (CATHODE).
- INSERT GREEN LED ACROSS T2 (ANODE) AND GROUND (CATHODE).
- CONNECT M1 TO GROUND (WHT).
- CONNECT J10 TO +9V (WHT).
- CONNECT SPRING 3 TO A5 (RED).
- CONNECT SPRING 4 TO L1 (RED).

2. TEST THE CIRCUIT

CHECK YOUR WIRING FOR ERRORS. BE SURE THE RED LED LEADS AND FOUR RESISTORS DO NOT TOUCH. PUSH THE POWER SWITCH ON. BOTH LEDES GLOW. TURN THE ROTATION SENSOR KNOB COUNTER-CLOCKWISE. THE GREEN LED GLOWS, AND THE RED LED FLICKERS. TURN THE KNOB FASTER. THE GREEN LED GLOWS AND THE RED LED SWITCHES OFF. ROTATE THE SENSOR KNOB CLOCKWISE. THE RED LED GLOWS, AND THE GREEN LED STAYS OFF, INDICATING WHEN THE SENSOR IS BEING ROTATED IN THE PROPER DIRECTION. OTHERWISE BOTH LEDES GLOW.

3. GOING FURTHER

YOU CAN SWITCH THE LEDES SO RED INDICATES THE SENSOR KNOB IS BEING ROTATED IN THE PROPER DIRECTION. CHANGE THE DIRECTION FROM CLOCKWISE TO COUNTER-CLOCKWISE BY SWITCHING THE RED WIRES AT SPRINGS 3 AND 4. YOU CAN CAUSE THE LEDES TO FADE IN (GRADUALLY TURN ON) AFTER THE ROTATION SENSOR IS NOT ROTATED. INSERT A 0.1 UF (104) CAPACITOR ACROSS A3 AND +9 VOLTS. ROTATE THE ROTATION SENSOR TO THE LEFT AND THE GREEN LED GLOWS. STOP THE ROTATION AND THE RED LED GRADUALLY GLOWS. ROTATE THE SENSOR TO THE RIGHT AND THE RED LED GLOWS. STOP THE ROTATION AND THE GREEN LED GRADUALLY GLOWS.

BUILD A BARGRAPH DIRECTION OF ROTATION INDICATOR

THE ROTATION SENSOR PRODUCES A POSITIVE VOLTAGE WHEN ROTATED CLOCKWISE AND A NEGATIVE VOLTAGE WHEN ROTATED COUNTER-CLOCKWISE. YOU WILL CONNECT THE BARGRAPH READOUT TO THE 272 OPERATIONAL AMPLIFIER TO INDICATE THE DIRECTION OF ROTATION.

PARTS YOU WILL NEED

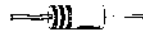
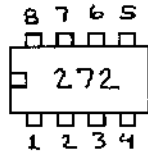

- R1-100 (BRN-BLK-BRN)
- R3-1K (BRN-BLK-RED)
- R4-10K (BRN-BLK-ORG)

CIRCUIT DIAGRAM

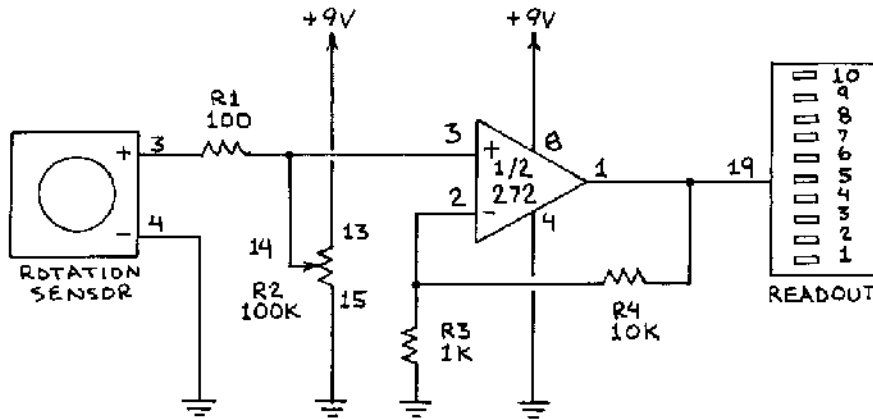

1. BUILD THE CIRCUIT

- | | |
|---|---|
| <ol style="list-style-type: none"> 1. <input type="checkbox"/> PUSH POWER AND DISPLAY SWITCHES OFF. 2. <input type="checkbox"/> INSERT 272 IC ACROSS SLOT (PIN 1 AT J5). 3. <input type="checkbox"/> INSERT R1 ACROSS A3 AND L3. 4. <input type="checkbox"/> INSERT R3 ACROSS K4 AND GROUND. 5. <input type="checkbox"/> INSERT R4 ACROSS J1 AND K1. 6. <input type="checkbox"/> CONNECT M1 TO GROUND (WHT). 7. <input type="checkbox"/> CONNECT J10 TO +9V (WHT). | <ol style="list-style-type: none"> 8. <input type="checkbox"/> CONNECT SPRING 3 TO A5 (RED). 9. <input type="checkbox"/> CONNECT SPRING 4 TO GROUND (BLU). 10. <input type="checkbox"/> CONNECT SPRING 13 TO +9V (BLU). 11. <input type="checkbox"/> CONNECT SPRING 14 TO L1 (RED). 12. <input type="checkbox"/> CONNECT SPRING 15 TO GROUND (RED). 13. <input type="checkbox"/> CONNECT SPRING 19 TO J4 (RED). |
|---|---|

2. TEST THE CIRCUIT

CHECK FOR WIRING ERRORS. PUSH THE POWER SWITCH ON AND THE DISPLAY MODE SWITCH TO DOT. ROTATE 100K CONSOLE POT R2 SO THAT THE NUMBER 5 OR 6 LED GLOWS. NOW ROTATE THE ROTATION SENSOR KNOB TO THE RIGHT (CLOCKWISE). SEVERAL FLICKERING READOUT DOTS MOVE UP, INDICATING A POSITIVE VOLTAGE. ROTATE THE SENSOR KNOB TO THE LEFT (COUNTER-CLOCKWISE). SEVERAL FLICKERING READOUT DOTS MOVE DOWN TO INDICATE A NEGATIVE VOLTAGE. NOTE THAT TURNING THE KNOB MORE RAPIDLY CAUSES THE CLUSTER OF DOTS TO MOVE FURTHER UP OR DOWN. THUS, THIS CIRCUIT INDICATES DIRECTION OF ROTATION WHILE PROVIDING A GENERAL IDEA OF THE SPEED OF ROTATION. TRY OPERATING THE CIRCUIT WHEN THE DISPLAY MODE SWITCH IS SET TO BAR. ADJUST R2 SO THAT LEDS 1-5 GLOW. ROTATE THE SENSOR KNOB TO THE RIGHT, AND THE COLUMN OF GLOWING LEDS MOVE UP. ROTATE THE SENSOR KNOB TO THE LEFT, AND THE BAR MOVES DOWN.

3. GOING FURTHER

YOU CAN REVERSE THE OPERATION OF THIS CIRCUIT BY SIMPLY SWITCHING THE TWO WIRES AT SPRINGS 3 AND 4. NOW THE READOUT LEDS WILL MOVE DOWN INSTEAD OF UP WHEN THE SENSOR KNOB IS ROTATED TO THE RIGHT.

BUILD AN AUDIO OUTPUT ROTATION SENSOR

VARIOUS ELECTRONIC AND MECHANICAL DEVICES CAN MEASURE HOW FAST AN OBJECT IS ROTATING. YOU WILL CONNECT THE ROTATION SENSOR TO A 555 TIMER CONNECTED AS AN AUDIO OSCILLATOR. THE OSCILLATION TONE WILL CHANGE NOTICEABLY WHEN THE SENSOR KNOB IS ROTATED IN EITHER DIRECTION.

PARTS YOU WILL NEED

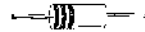
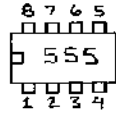

R3-10K (BRN-BLK-ORG)
R4-270 (RED-VIO-BRN)



C1-0.01 uF (103)

CIRCUIT DIAGRAM

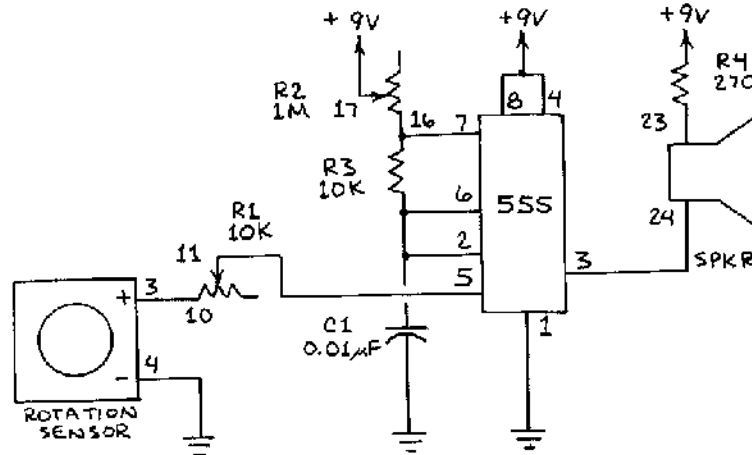

1. BUILD THE CIRCUIT

1. PUSH POWER AND DISPLAY SWITCHES OFF.
2. INSERT 555 IC ACROSS SLOT (PIN 1 AT J5).
3. INSERT C1 ACROSS J1 AND K1.
4. INSERT R3 ACROSS K10 AND L10.
5. INSERT R4 ACROSS C6 AND +9V.
6. CONNECT J2 TO GROUND (WHT).
7. CONNECT J10 TO +9V (WHT).
8. CONNECT K4 TO L7 (WHT).
9. CONNECT M4 TO J7 (WHT).
10. CONNECT SPRINGS 3 AND 10 (BLU).
11. CONNECT SPRING 4 TO GROUND (BLU).
12. CONNECT SPRING 11 TO M7 (BLU).
13. CONNECT SPRING 17 TO +9V (BLU).
14. CONNECT SPRING 16 TO K9 (BLU).
15. CONNECT SPRING 23 TO C10 (RED).
16. CONNECT SPRING 24 TO L4 (RED).

2. TEST THE CIRCUIT

CHECK FOR ERRORS. PUSH THE POWER SWITCH UP. YOU WILL HEAR A TONE FROM THE SPEAKER. ROTATE 10K CONSOLE POT R1 ALL THE WAY TO THE RIGHT. ADJUST 1M CONSOLE POT R2 UNTIL THE TONE HAS A HIGH FREQUENCY. NOW SPIN THE ROTATION SENSOR KNOB TO THE RIGHT. THIS WILL CAUSE THE FREQUENCY OF THE TONE TO RISE. NEXT, SPIN THE ROTATION SENSOR KNOB TO THE LEFT. THE FREQUENCY OF THE TONE WILL FALL. EXPERIMENT WITH THE SETTING OF R1 FOR BEST RESULTS. IF YOU ROTATE R1 ALL THE WAY TO THE RIGHT, THE TONE WILL BECOME A CHIRP EACH TIME YOU ROTATE THE SENSOR KNOB.

3. GOING FURTHER

THIS CIRCUIT USES THE CONTROL INPUT OF THE 555 (PIN 5). WHEN PIN 5 IS LEFT OPEN (UNCONNECTED), THE CIRCUIT OSCILLATES AT A FREQUENCY DETERMINED BY C1 AND R2. APPLYING A VOLTAGE TO PIN 5 ALTERS THIS FREQUENCY. IN THIS CIRCUIT, THE ROTATION SENSOR APPLIES A VARIABLE VOLTAGE TO PIN 5.

BUILD AN ELECTROMAGNETIC SIGNAL RECEIVER

YOU WILL USE THE INDUCTION COIL AS A SENSOR FOR A CIRCUIT THAT CONVERTS ELECTROMAGNETIC FIELDS INTO SOUND. USE THE CIRCUIT TO DETECT THE ELECTROMAGNETIC FIELDS FROM A TELEPHONE RECEIVER AND OTHER ELECTROMAGNETIC FIELDS.

PARTS YOU WILL NEED

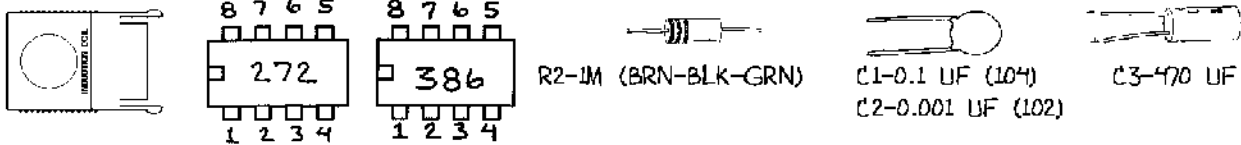

CIRCUIT DIAGRAM

ADD THE REMOTE LINK TO USE THE INDUCTION COIL AS A PROBE.

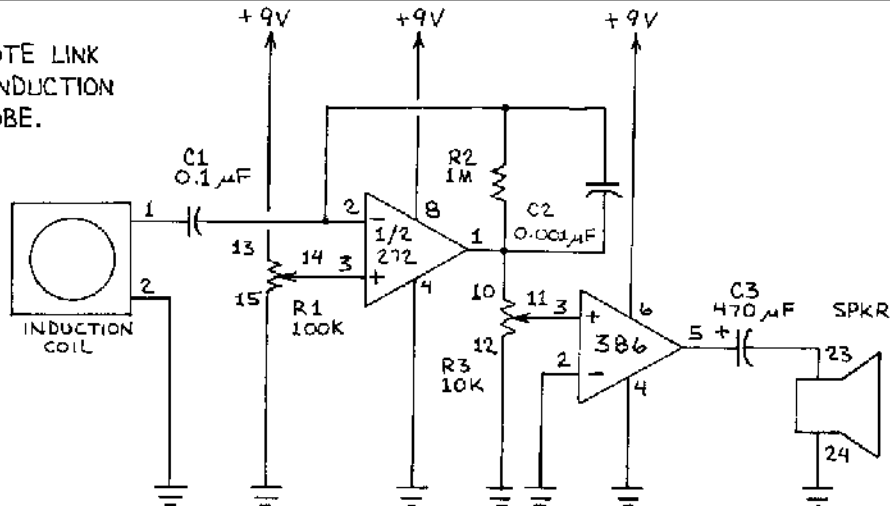

1. BUILD THE CIRCUIT

1. INSERT INDUCTION COIL IN SENSOR SOCKET.
2. INSERT 272 IC ACROSS SLOT (PIN 1 AT C5).
3. INSERT 386 IC ACROSS SLOT (PIN 1 AT L5).
4. INSERT R2 ACROSS C4 AND D4.
5. INSERT C1 ACROSS SPRING 1 AND D1.
6. INSERT C2 ACROSS C3 AND D3.
7. INSERT C3 ACROSS O8 (+) AND K8 (-).
8. CONNECT F1 AND GROUND (RED).
9. CONNECT C10 TO +9V (WHT).
10. CONNECT M1 TO GROUND (WHT).
11. CONNECT O1 TO GROUND (WHT).
12. CONNECT N7 TO +9V (RED).
13. CONNECT SPRING 2 TO GROUND (BLU).
14. CONNECT SPRING 10 TO C1 (BLU).
15. CONNECT SPRING 11 TO N4 (RED).
16. CONNECT SPRING 12 TO GROUND (RED).
17. CONNECT SPRING 13 TO +9V (BLU).
18. CONNECT SPRING 14 TO E1 (BLU).
19. CONNECT SPRING 15 TO GROUND (RED).
20. CONNECT SPRING 23 TO K10 (RED).
21. CONNECT SPRING 24 TO GROUND (RED).

2. TEST THE CIRCUIT

CHECK YOUR CONNECTIONS AND THAT THE BARE LEADS OF THE COMPONENTS DO NOT TOUCH. ROTATE 10K CONSOLE POT R3 AND 100K POT R1 ALL THE WAY TO THE LEFT. BEFORE YOU PUSH THE POWER SWITCH ON, PLACE THE CONSOLE NEAR A COMPUTER MONITOR OR TV SET, OR PLACE A TELEPHONE RECEIVER NEAR THE INDUCTION COIL CARD. PUSH THE POWER SWITCH ON. ROTATE R3 SLIGHTLY TO THE RIGHT, THEN ROTATE R1 UNTIL YOU HEAR A BUZZ. ADJUST R1 UNTIL THE BUZZ SOUNDS BEST. USE R3 AS A VOLUME CONTROL TO ADJUST THE SOUND.

3. GOING FURTHER

ON PAGE 37 YOU WILL ADD THE LED BARGRAPH READOUT TO THE CIRCUIT.

ADD AN LED BARGRAPH READOUT TO THE ELECTROMAGNETIC SIGNAL RECEIVER

YOU WILL USE THE SECOND AMPLIFIER IN THE 272 TO DRIVE THE LED BARGRAPH READOUT. THE READOUT SERVES AS A SIGNAL STRENGTH INDICATOR. YOU WILL ALSO PERFORM VARIOUS EXPERIMENTS WITH THE ELECTROMAGNETIC SIGNAL RECEIVER.

PARTS YOU WILL NEED

 R4-1K (BRN-BLK-RED)
 R5-3.3K (ORG-ORG-RED)
 R6-100K (BRN-BLK-YEL)

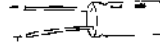
 C4-1 UF

 C5-0.1 UF (10%)

CIRCUIT DIAGRAM

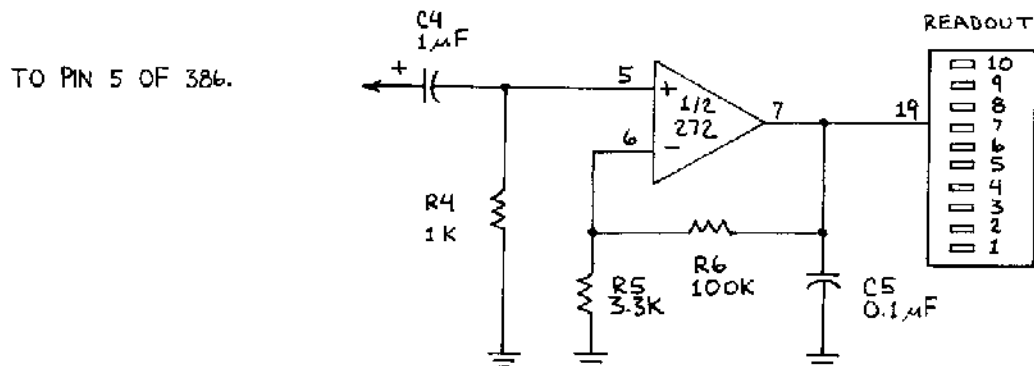

1. MODIFY THE CIRCUIT ON PAGE 36.

BEFORE STARTING, ADJUST THE CIRCUIT ON PAGE 36 FOR THE BEST RESULTS.

- | | |
|--|---|
| 1. <input type="checkbox"/> PUSH POWER AND DISPLAY SWITCHES OFF. | 5. <input type="checkbox"/> INSERT C4 ACROSS J10 (+) AND F10 (-). |
| 2. <input type="checkbox"/> INSERT R4 ACROSS F2 AND F7. | 6. <input type="checkbox"/> INSERT C5 ACROSS F4 AND D7. |
| 3. <input type="checkbox"/> INSERT R5 ACROSS F3 AND E7. | 7. <input type="checkbox"/> CONNECT O7 TO J7 (WHT). |
| 4. <input type="checkbox"/> INSERT R6 ACROSS D10 AND E10. | 8. <input type="checkbox"/> CONNECT SPRING 19 TO D8 (RED). |

2. TEST THE CIRCUIT

CHECK FOR ERRORS. BE SURE THAT THE BARE LEADS OF THE COMPONENTS DO NOT TOUCH. PLACE THE CONSOLE NEAR A COMPUTER MONITOR OR OTHER SOURCE OF ELECTROMAGNETIC RADIATION. PUSH THE POWER SWITCH ON. YOU HEAR A BUZZ FROM THE SPEAKER AS BEFORE. IF NOT, ADJUST THE CIRCUIT AS DESCRIBED ON PAGE 36 AND TRY AGAIN. WHEN THE CIRCUIT IS WORKING PROPERLY, PUSH THE DISPLAY MODE SWITCH TO BAR. WATCH THE BARGRAPH WHILE MOVING THE CONSOLE AWAY AND TOWARD THE SOURCE OF ELECTROMAGNETIC RADIATION. THE ROW OF GLOWING LEDS RISES WHEN YOU MOVE THE CONSOLE TOWARD THE ELECTROMAGNETIC SOURCE AND FALLS WHEN YOU MOVE THE CONSOLE AWAY.

3. GOING FURTHER

YOU CAN PERFORM MANY EXPERIMENTS WITH YOUR ELECTROMAGNETIC RECEIVER AND ITS SIGNAL STRENGTH INDICATOR. FOR BEST RESULTS, DISCONNECT THE SPEAKER SO THAT IT DOES NOT DISTRACT YOU. REPEAT THE EXPERIMENT DESCRIBED ABOVE BY MOVING THE CONSOLE TOWARD AND AWAY FROM AN ELECTROMAGNETIC SOURCE. REMOVE THE INDUCTION COIL CARD FROM THE CONSOLE AND CONNECT IT TO THE CONSOLE USING THE REMOTE LINK. NOW USE THE INDUCTION COIL AS A PROBE TO CHECK FOR ELECTROMAGNETIC FIELDS. TRY MOVING THE COIL CARD BACK AND FORTH ACROSS THE SCREEN OF A COMPUTER MONITOR OR TV SET WHILE WATCHING THE BARGRAPH READOUT. NOTICE THAT THE STRENGTH OF AN ELECTROMAGNETIC FIELD CAN VARY GREATLY, EVEN OVER RELATIVELY SHORT DISTANCES.

BUILD AN ELECTROMAGNETIC PULSE SOURCE FOR THE ELECTROMAGNETIC SIGNAL RECEIVER

YOU WILL USE THE 555 TIMER IC TO BUILD A SIMPLE ELECTROMAGNETIC PULSE GENERATOR. THE ELECTROMAGNETIC PULSES ARE COUPLED INTO THE AIR BY MEANS OF THE 1000-OHM COIL IN THE CONSOLE TRANSFORMER. YOU WILL USE THE INDUCTION COIL AND THE REMOTE LINK TO DETECT THE FIELD AROUND THE TRANSFORMER.

PARTS YOU WILL NEED

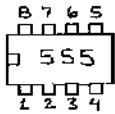

R6-10K (BRN-BLK-ORG)
R7-1K (BRN-BLK-RED)

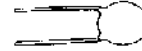

C5-0.1 uF (104)

CIRCUIT DIAGRAM

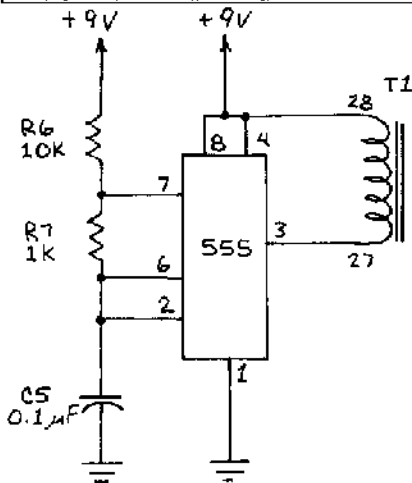

1. EXPAND THE CIRCUIT ON PAGE 37

BEFORE STARTING, ADJUST THE CIRCUIT ON PAGE 37 TO GIVE BEST RESULTS.

1. PUSH THE POWER AND DISPLAY SWITCHES OFF.
2. INSERT 555 IC ACROSS SLOT (PIN 1 AT Q5).
3. INSERT R6 ACROSS Q9 AND R9.
4. INSERT R7 ACROSS R10 AND S10.
5. INSERT C5 ACROSS Q1 AND R1.
6. CONNECT Q2 TO GROUND (WHT).
7. CONNECT Q8 TO N8 (WHT).
8. CONNECT R4 TO S7 (WHT).
9. CONNECT T4 TO Q7 (WHT).
10. CONNECT SPRING 27 TO S4 (RED).
11. CONNECT SPRING 28 TO Q10 (RED).

2. TEST THE CIRCUIT

YOUR BREADBOARD IS NOW STUFFED WITH WIRES AND PARTS. CHECK CAREFULLY FOR ERRORS. BE SURE THAT EXPOSED COMPONENT LEADS DO NOT TOUCH AND THAT WIRES ARE NOT LOOSE. USE THE REMOTE LINK TO CONNECT THE INDUCTION COIL CARD TO THE CONSOLE. PUSH THE POWER SWITCH ON. IF YOU LEFT THE RECEIVER CIRCUIT ADJUSTED AS DESCRIBED ON PAGE 37, YOU HEAR A HIGH-PITCHED TONE FROM THE SPEAKER. THIS IS THE SIGNAL FROM THE 555 PULSE GENERATOR BEING COUPLED TO THE NEARBY RECEIVER WIRING AND THE COMMON POWER SUPPLY LEADS. NOW PLACE THE INDUCTION COIL CARD NEAR THE CONSOLE TRANSFORMER. THE MUSICAL TONE IS LOUDER THAN BEFORE. IF THE CIRCUIT IS NOISY AND DOES NOT RESPOND PROPERLY, FOLLOW THE INSTRUCTIONS ON PAGE 37 TO READJUST THE 10K AND 100K CONSOLE POTENTIOMETERS. THE PULSES FROM THE 555 PULSE GENERATOR ARE CONVERTED INTO AN ELECTROMAGNETIC FIELD BY THE 1000-OHM COIL OF THE TRANSFORMER. THE STRENGTH OR INTENSITY OF THE FIELD DECREASES WITH DISTANCE. THEREFORE THE SIGNAL IS LOUDEST WHEN THE INDUCTION COIL CARD IS AS CLOSE AS POSSIBLE TO THE TRANSFORMER.

3. GOING FURTHER

USE THE INDUCTION COIL CARD AS A PROBE TO FIND OUT IF OTHER PARTS OF THE CONSOLE ALSO EMIT ELECTROMAGNETIC PULSES. THE CONSOLE SPEAKER AND THE TWO WIRES THAT LEAD TO THE TRANSFORMER ARE GOOD SOURCES. REMOVE THE REMOTE LINK FROM THE CONSOLE SOCKET. NOTICE THAT THE BACKGROUND TONE REMAINS. THIS PROVES THAT THE SIGNAL FROM THE 555 PULSE GENERATOR IS LEAKING INTO THE RECEIVER CIRCUIT THROUGH THE CONNECTION WIRES AND THE SHARED POWER SUPPLY.

USE A MAGNET TO CAUSE AN LED TO FLASH AND FLICKER

YOU WILL BUILD A VERY SENSITIVE TWO-STAGE AMPLIFIER THAT BOOSTS THE TINY SIGNALS INDUCED INTO THE INDUCTION COIL SENSOR WHEN THE MAGNET IS MOVED NEARBY. THE AMPLIFIED SIGNAL DRIVES AN LED, WHICH FLASHES AND FLICKERS WHEN THE MAGNET IS MOVED BACK AND FORTH PAST THE INDUCTION COIL SENSOR.

PARTS YOU WILL NEED

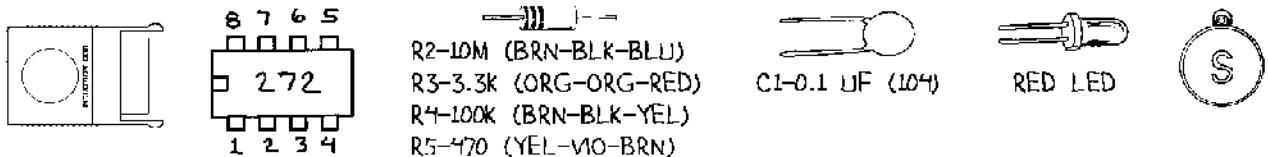

CIRCUIT DIAGRAM

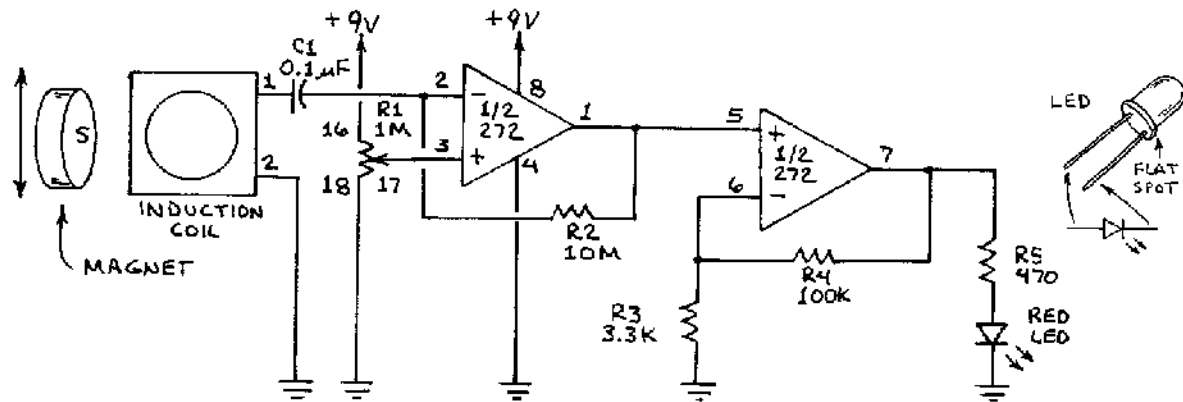

1. BUILD THE CIRCUIT

1. PUSH POWER AND DISPLAY SWITCHES OFF.
2. INSERT INDUCTION COIL IN SENSOR SOCKET.
3. INSERT 272 IC ACROSS SLOT (PIN 1 AT C5).
4. INSERT R2 ACROSS C1 AND D1.
5. INSERT R3 ACROSS F3 AND E7.
6. INSERT R4 ACROSS D10 AND E10.
7. INSERT R5 ACROSS D9 AND H5.
8. INSERT C1 ACROSS SPRING 1 AND D3.
9. INSERT LED ACROSS H2 (ANODE) AND F2 (CATHODE).
10. CONNECT F1 TO GROUND (RED).
11. CONNECT C10 TO +9V (WHT).
12. CONNECT C4 TO F7 (WHT).
13. CONNECT SPRING 2 TO F4 (RED).
14. CONNECT SPRING 16 TO +9V (BLU).
15. CONNECT SPRING 17 TO E4 (BLU).
16. CONNECT SPRING 18 TO GROUND (BLU).

2. TEST THE CIRCUIT

THE CIRCUIT PART LEADS ARE CLOSE TO ONE ANOTHER. CHECK YOUR WIRING AND MAKE SURE NONE OF THE EXPOSED LEADS TOUCH. ROTATE 1M CONSOLE POT R1 ALL THE WAY TO THE LEFT. PUSH THE POWER SWITCH ON AND SLOWLY ROTATE R1 TO THE RIGHT UNTIL THE LED GLOWS. BACK OFF SLIGHTLY ON R1 UNTIL THE LED SWITCHES OFF. THE CIRCUIT IS NOW SET FOR MAXIMUM SENSITIVITY TO ELECTRICAL SIGNALS INDUCED INTO THE INDUCTION COIL BY THE MAGNET. RUB THE MAGNET AGAINST THE BACK SIDE OF THE INDUCTION COIL CARD. THE LED FLASHES IN RESPONSE BECAUSE THE MAGNET'S MOVING FIELD GENERATES TINY ELECTRICAL CURRENTS IN THE COIL. WHEN THESE SIGNALS ARE AMPLIFIED, THE LED FLASHES.

3. GOING FURTHER

THIS CIRCUIT CAN ALSO BE USED WITH THE LED BARGRAPH. PUSH THE POWER SWITCH OFF. CONNECT A RED WIRE FROM SPRING 19 TO F8. SWITCH THE POWER ON AND PUSH THE DISPLAY MODE SWITCH TO BAR. ADJUST R1 UNTIL ONLY LED 1 OR 2 OF THE READOUT GLOWS. RUB THE MAGNET AGAINST THE BACK OF THE INDUCTION COIL CARD AND WATCH THE LEDS.

USE A MAGNET TO ALTER AN AUDIO TONE

YOU WILL USE THE INDUCTION COIL SENSOR CARD IN A CIRCUIT THAT RESPONDS TO A MOVING MAGNET BY ALTERING THE FREQUENCY OF AN AUDIO TONE.

PARTS YOU WILL NEED

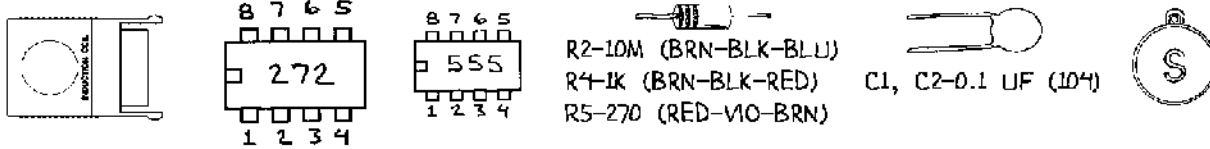

CIRCUIT DIAGRAM

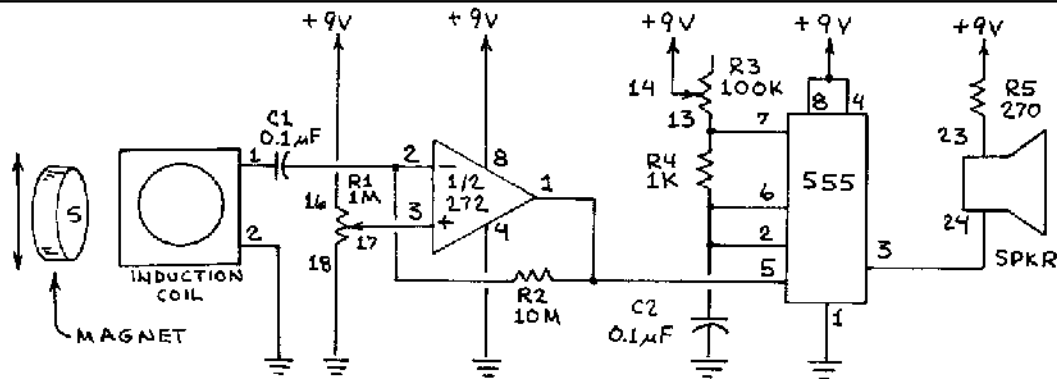

1. BUILD THE CIRCUIT

1. PUSH POWER AND DISPLAY SWITCHES OFF.
2. INSERT INDUCTION COIL IN SENSOR SOCKET.
3. INSERT 272 IC ACROSS SLOT (PIN 1 AT C5).
4. INSERT 555 IC ACROSS SLOT (PIN 1 AT Q5).
5. INSERT R2 ACROSS C1 AND D1.
6. INSERT R4 ACROSS R10 AND S10.
7. INSERT R5 ACROSS SPRING 23 AND +9V.
8. INSERT C1 ACROSS SPRING 1 AND D3.
9. INSERT C2 ACROSS Q1 AND R1.
10. CONNECT Q2 TO GROUND (WHT).
11. CONNECT R4 TO S7 (WHT).
12. CONNECT T4 TO Q7 (WHT).
13. CONNECT C4 TO T7 (RED).
14. CONNECT Q10 TO +9V (RED).
15. CONNECT F1 TO GROUND (RED).
16. CONNECT C10 TO +9V (WHT).
17. CONNECT SPRING 2 TO F4 (RED).
18. CONNECT SPRING 13 TO R9 (RED).
19. CONNECT SPRING 14 TO Q9 (RED).
20. CONNECT SPRING 16 TO +9V (BLU).
21. CONNECT SPRING 17 TO E4 (BLU).
22. CONNECT SPRING 18 TO GROUND (BLU).
23. CONNECT SPRING 24 TO S4 (RED).

2. TEST THE CIRCUIT

INSPECT YOUR WIRING FOR ERRORS. ROTATE 100K CONSOLE POT R3 TO MIDPOINT. ROTATE 1M CONSOLE POT R1 ALL THE WAY TO THE LEFT, THEN PUSH POWER ON. YOU HEAR A MUSICAL TONE. ROTATE R1 TO THE RIGHT UNTIL THE TONE SOUNDS SCRATCHY. RUB THE MAGNET AGAINST THE BACK OF THE INDUCTION COIL CARD. THE TONE FREQUENCY CHANGES AS YOU MOVE THE MAGNET. WHEN THE MAGNET IS STILL, THE TONE RETURNS TO ITS ORIGINAL VALUE. EXPERIMENT WITH THE CIRCUIT BY ADJUSTING R3 WHILE MOVING THE MAGNET AGAINST THE INDUCTION COIL CARD. THIS CHANGES THE BASE FREQUENCY OF THE TONE AND MAY CAUSE MORE OBVIOUS FLUCTUATIONS. AFTER FINDING A SETTING THAT GIVES GOOD RESULTS, ADJUST R1 WHILE MOVING THE MAGNET AGAINST THE INDUCTION COIL CARD.

3. GOING FURTHER

CREATE A FREQUENCY CHANGE BY SWINGING THE MAGNET BY THE BACK OF THE INDUCTION COIL CARD. PLACE A PIECE OF CARDBOARD OR PLASTIC AGAINST SPRINGS 3 AND 21 TO KEEP THE MAGNET FROM BEING ATTRACTED TO THESE SPRINGS, THEN SWING.

BUILD A COMPASS BOUNCER

THE CIRCUIT ON PAGE 25 SHOWS HOW AN ELECTROMAGNETIC PULSE DEFLECTS THE COMPASS NEEDLE. YOU WILL BUILD A PULSE GENERATOR THAT AUTOMATICALLY APPLIES A SERIES OF PULSES TO THE INDUCTION COIL SENSOR CARD. EACH PULSE DEFLECTS THE COMPASS NEEDLE.

PARTS YOU WILL NEED

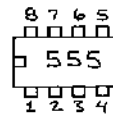
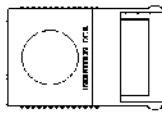

R2-10K (BRN-BLK-ORG)

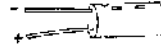
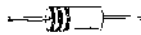

C1-100 UF

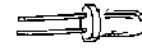

RED LED



COMPASS

CIRCUIT DIAGRAM

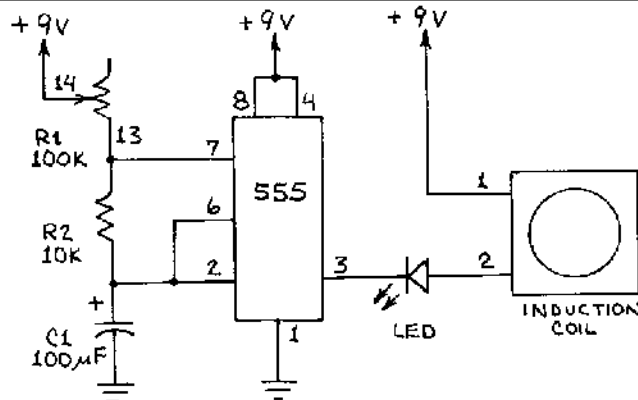

COMPASS

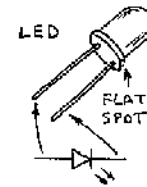

1. BUILD THE CIRCUIT

1. PUSH POWER AND DISPLAY SWITCHES OFF.
2. INSERT INDUCTION COIL CARD IN SENSOR SOCKET.
3. INSERT 555 IC ACROSS SLOT (PIN 1 AT Q5).
4. INSERT R2 ACROSS R10 AND S10.
5. INSERT C1 ACROSS R1 (+) AND Q1 (-).
6. INSERT LED ACROSS F9 (ANODE) AND H9 (CATHODE).
7. CONNECT Q2 TO GROUND (WHT).
8. CONNECT Q10 TO +9V (RED).
9. CONNECT R4 TO S7 (WHT).
10. CONNECT T4 TO Q7 (WHT).
11. CONNECT S4 TO H6 (RED).
12. CONNECT SPRING 1 TO +9V (WHT).
13. CONNECT SPRING 2 TO F10 (WHT).
14. CONNECT SPRING 13 TO R8 (BLU).
15. CONNECT SPRING 14 TO Q8 (BLU).

2. TEST THE CIRCUIT

CHECK YOUR WIRING AND CORRECT ANY ERRORS. ROTATE 100K CONSOLE POT R1 2/3 OF THE WAY TO THE RIGHT. PUSH THE POWER SWITCH UP, AND THE LED FLASHES EVERY FEW SECONDS. NOW PLACE THE COMPASS NEAR THE INDUCTION COIL. EACH TIME THE LED FLASHES, THE COMPASS NEEDLE IS SHARPLY DEFLECTED. THE DEFLECTIONS ARE STRONGEST WHEN THE COMPASS IS HELD VERY CLOSE TO THE CENTER OF THE INDUCTION COIL CARD.

3. GOING FURTHER

FOR BEST RESULTS, ROTATE THE CONSOLE TO FACE EAST OR WEST. NOW THE COMPASS NEEDLE IS PARALLEL TO THE INDUCTION COIL. SINCE THE NORTH OR SOUTH END OF THE COMPASS NEEDLE IS ATTRACTED TO THE COIL, THE COMPASS DEFLECTION IS MUCH MORE OBVIOUS. TO SPEED UP DEFLECTIONS, REPLACE C1 WITH A 10 UF CAPACITOR. INSERT THE + LEAD AT R1 AND THE - LEAD AT Q1. YOU CAN DETECT THE ELECTROMAGNETIC PULSES FROM THE INDUCTION COIL WITH A TRANSISTOR RADIO. TUNE THE RADIO TO AN UNUSED SPOT NEAR THE LOW END OF THE AM BAND (BELOW ABOUT 600 KHZ). PLACE THE RADIO'S SIDE WITH THE ANTENNA COIL NEAR THE INDUCTION COIL. LISTEN CAREFULLY, AND YOU HEAR A CLICK EACH TIME THE LED FLASHES.

BUILD A BASIC MAGNET DETECTOR

YOU WILL USE THE MAGNET SENSOR (HALL-EFFECT SENSOR) TO BUILD A BASIC MAGNET SENSOR. WHEN THE SOUTH POLE OF THE MAGNET IS PLACED NEAR THE LEFT SIDE OF THE MAGNET SENSOR, A RED LED WILL GLOW.

PARTS YOU WILL NEED

R1-1K (BRN-BLK-RED)

RED LED



CIRCUIT DIAGRAM

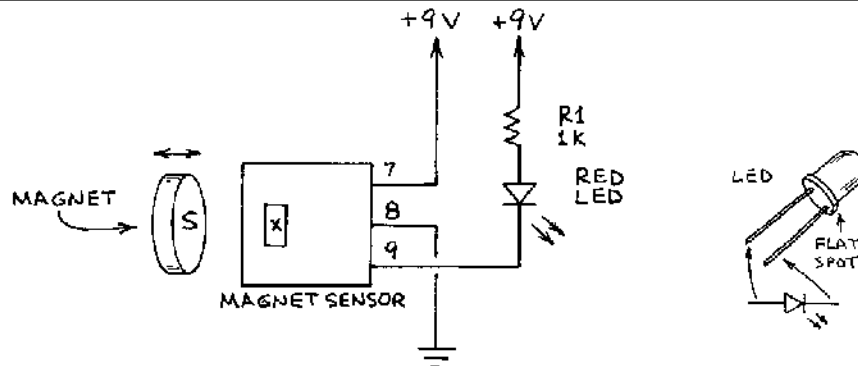

1. BUILD THE CIRCUIT

- PUSH POWER AND DISPLAY SWITCHES OFF.
- INSERT RED LED ACROSS H5 (ANODE) AND J5 (CATHODE).
- INSERT R1 ACROSS H1 AND +9V.
- CONNECT SPRING 7 TO +9V. (RED).
- CONNECT SPRING 8 TO GROUND. (RED).
- CONNECT SPRING 9 TO J1 (RED).

2. TEST THE CIRCUIT

CHECK YOUR WIRING FOR ERRORS. PUSH THE POWER SWITCH ON. THE LED REMAINS OFF. PLACE THE SOUTH POLE OF THE MAGNET NEAR THE LEFT SIDE OF THE MAGNET SENSOR. THE LED GLOWS WHEN THE MAGNET IS WITHIN ABOUT 1 CM (0.4 INCH) FROM THE MAGNET SENSOR.

SLOWLY MOVE THE MAGNET AWAY FROM THE MAGNET SENSOR. THE LED WILL SWITCH OFF WHEN THE MAGNET IS SEVERAL CENTIMETERS OR MORE AWAY FROM THE SENSOR. MOVE THE MAGNET BACK TOWARD THE SENSOR TO SWITCH THE LED ON AGAIN.

3. GOING FURTHER

YOU CAN PLACE VARIOUS MATERIALS BETWEEN THE MAGNET AND THE MAGNET SENSOR TO DETERMINE IF THEY WILL BLOCK THE MAGNET'S FIELD. WITH THE CIRCUIT SWITCHED ON, PLACE THE SOUTH POLE OF THE MAGNET NEAR THE MAGNET SENSOR UNTIL THE LED GLOWS. THEN MOVE THE MAGNET SLIGHTLY FARTHER AWAY. NOW HOLD THE MAGNET IN PLACE WHILE PLACING VARIOUS MATERIALS BETWEEN THE MAGNET AND THE MAGNET SENSOR. PAPER, PLASTIC, AND ALUMINUM HAVE NO EFFECT. OBJECTS MADE FROM STEEL, HOWEVER, WILL EXTINGUISH THE LED WHEN THEY ARE PLACED BETWEEN THE MAGNET AND THE MAGNET SENSOR. COMMON STEEL OBJECTS INCLUDE SCREWDRIVERS, TWEEZERS, AND WASHERS.

EVEN A PAPERCLIP HAS THIS EFFECT. WHILE HOLDING THE MAGNET IN PLACE, PUT THE END OF THE PAPERCLIP ONTO THE SURFACE OF THE MAGNET SENSOR. YOU SHOULD BE ABLE TO EXTINGUISH THE LED BY MOVING THE PAPERCLIP AGAINST THE FRONT OF THE SENSOR.

USE A MAGNET TO SWITCH ON THE BUZZER

YOU WILL USE TWO TRANSISTORS TO BUILD A SIMPLE CIRCUIT THAT SWITCHES ON THE BUZZER WHEN THE MAGNET IS BROUGHT NEAR THE MAGNET SENSOR.

PARTS YOU WILL NEED

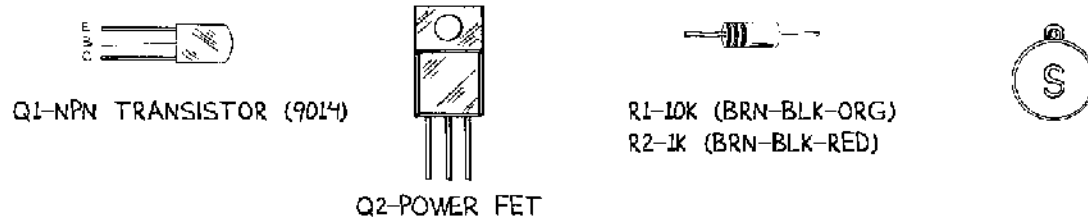

CIRCUIT DIAGRAM

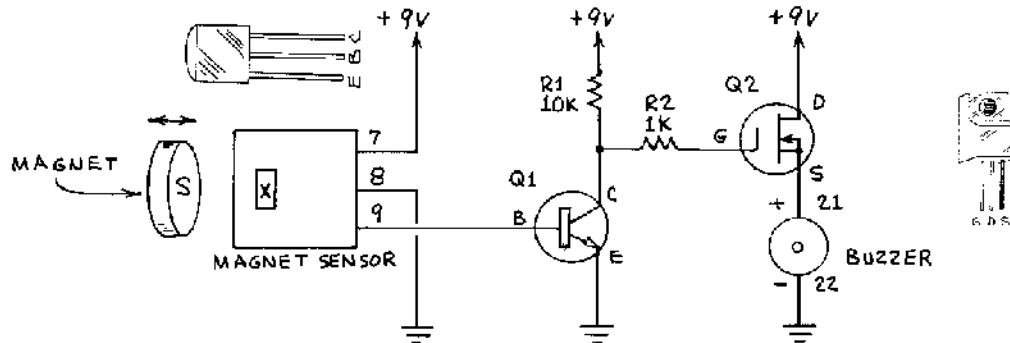

1. BUILD THE CIRCUIT

1. PUSH POWER AND DISPLAY SWITCHES OFF.
2. INSERT Q1 AT H8 (E), G8 (B) AND F8 (C).
3. INSERT Q2 AT C1 (G), B1 (D) AND A1 (S).
4. INSERT R2 ACROSS C5 AND F6.
5. INSERT R1 ACROSS F10 AND +9V.
6. CONNECT H10 TO GROUND (RED).
7. CONNECT B5 TO +9V (WHT).
8. CONNECT SPRING 7 TO +9V (RED).
9. CONNECT SPRING 8 GROUND (RED).
10. CONNECT SPRING 9 TO G6 (RED).
11. CONNECT SPRING 21 TO A5 (RED).
12. CONNECT SPRING 22 TO GROUND (BLU).

2. TEST THE CIRCUIT

CHECK YOUR WIRING FOR ERRORS. PUSH THE POWER SWITCH ON AND NOTHING HAPPENS. PLACE THE SOUTH SIDE OF THE MAGNET NEAR THE LEFT SIDE OF THE MAGNET SENSOR. THE BUZZER SOUNDS WHEN THE MAGNET IS WITHIN ABOUT 1 CM (0.4 INCH) FROM THE MAGNET SENSOR. AS WITH THE LED CIRCUIT ON PAGE 42, ONCE THE BUZZER IS ON IT STAYS ON UNTIL YOU MOVE THE MAGNET MORE THAN A FEW CENTIMETERS AWAY FROM THE MAGNET SENSOR. AFTER THE BUZZER SWITCHES OFF, PLACE THE MAGNET NO MORE THAN ABOUT 1 CM AWAY FROM THE MAGNET SENSOR FOR THE CIRCUIT TO ACTIVATE THE BUZZER. THIS WILL HELP YOU BETTER UNDERSTAND HOW THE MAGNET SENSOR IS SWITCHED ON AND OFF BY THE MAGNET. THE MAGNET SENSOR IS A SEMICONDUCTOR DEVICE CALLED A HALL SENSOR. IT SWITCHES ON ONLY WHEN THE PROPER POLE OF THE MAGNET FACES THE SENSOR. WHEN YOU PLACE THE NORTH SIDE OF THE MAGNET NEAR THE LEFT SIDE OF THE MAGNET SENSOR, NOTHING HAPPENS. WHEN YOU PLACE THE NORTH SIDE OF THE MAGNET NEAR THE RIGHT SIDE OF THE MAGNET SENSOR, THE BUZZER SOUNDS. THIS EXPERIMENT DEMONSTRATES THAT THE MAGNET SENSOR IS SENSITIVE TO THE DIRECTION OF THE MAGNETIC FIELD.

3. GOING FURTHER

USE A PLASTIC OR WOOD RULER TO MEASURE THE DISTANCE BETWEEN THE MAGNET AND THE MAGNET SENSOR WHEN THE BUZZER FIRST SWITCHES ON. THEN MEASURE THE DISTANCE THE MAGNET CAN BE MOVED AWAY FROM THE MAGNET SENSOR BEFORE THE BUZZER STOPS.

USE A MAGNET TO SWITCH OFF THE BUZZER

USE A POWER FET TO TURN OFF THE BUZZER WHEN A MAGNET NEARS THE SENSOR. THIS CIRCUIT ILLUSTRATES HOW MAGNET SENSORS ARE USED IN SECURITY SYSTEMS.

PARTS YOU WILL NEED



Q1-POWER FET



R1-1K (BRN-BLK-RED)



CIRCUIT DIAGRAM

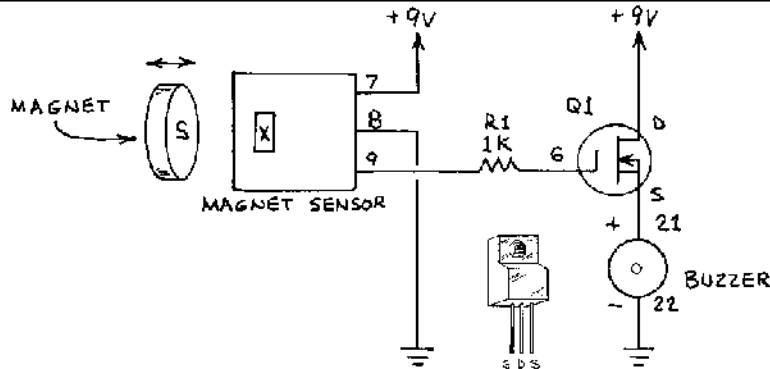

1. BUILD THE CIRCUIT

1. PUSH POWER AND DISPLAY SWITCHES OFF.
2. INSERT Q1 AT C1 (G), B1 (D) AND A1 (S).
3. INSERT R1 ACROSS C5 AND H5.
4. CONNECT B5 TO +9V (WHT).
5. CONNECT SPRING 7 TO +9V (RED).
6. CONNECT SPRING 8 TO GROUND (RED).
7. CONNECT SPRING 9 TO H1 (RED).
8. CONNECT SPRING 21 TO A5 (RED).
9. CONNECT SPRING 22 TO GROUND (BLU).

2. TEST THE CIRCUIT

CHECK THE CIRCUIT FOR ERRORS. PUSH THE POWER SWITCH ON AND THE BUZZER SOUNDS LOUDLY. BRING THE SOUTH POLE OF THE MAGNET NEAR THE LEFT SIDE OF THE MAGNET SENSOR. WHEN THE MAGNET COMES WITHIN ABOUT 1 CM (0.4 INCH) OF THE MAGNET SENSOR, THE BUZZER SWITCHES OFF. IT REMAINS OFF EVEN WHEN YOU MOVE THE MAGNET MORE THAN 1 CM AWAY FROM THE SENSOR. YOU CAN EASILY DEMONSTRATE THE OPERATION OF A WINDOW OR DOOR INTRUSION ALARM. SWITCH THE POWER OFF. WHILE HOLDING THE SOUTH POLE OF THE MAGNET NEAR OR AGAINST THE LEFT SIDE OF THE MAGNET SENSOR, PUSH POWER ON. THE BUZZER IS SILENT. MOVE THE MAGNET AWAY FROM THE MAGNET SENSOR. THE BUZZER SOUNDS. IN MOST INTRUSION ALARMS, THE MAGNET IS MOUNTED ON A MOVING OBJECT AND THE MAGNET SENSOR IS MOUNTED ON A FIXED OBJECT. THE ALARM IS SILENT WHEN THE DOOR IS CLOSED AND THE MAGNET IS CLOSE TO THE SENSOR. WHEN THE DOOR IS OPENED, THE MAGNET IS SEPARATED FROM THE SENSOR, AND THE ALARM SOUNDS.

3. GOING FURTHER

YOU CAN ADD A RED LED TO THIS CIRCUIT THAT GLOWS WHEN THE BUZZER SOUNDS. YOU WILL NEED A RED LED AND R2, A 1K RESISTOR (BRN-BLK-RED). PUSH THE POWER SWITCH ON AND REPEAT THE ABOVE EXPERIMENTS. THE LED GLOWS EACH TIME THE BUZZER SOUNDS.

1. PUSH POWER AND DISPLAY SWITCHES OFF.
2. INSERT R2 ACROSS A4 AND E6.
3. INSERT RED LED ACROSS E8 (ANODE) AND G8 (CATHODE).
4. CONNECT G10 TO GROUND (RED).

USE A MAGNET TO SWITCH ON AN LED FOR A FIXED TIME

YOU WILL BUILD A MONOSTABLE MULTIVIBRATOR CIRCUIT THAT CAUSES A LED TO GLOW FOR A FIXED PERIOD OF TIME WHEN THE MAGNET IS PLACED NEAR THE MAGNET SENSOR. THE LED CONTINUES TO GLOW EVEN WHEN THE MAGNET IS MOVED AWAY FROM THE MAGNET SENSOR.

PARTS YOU WILL NEED

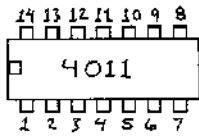

R1, R2-100K (BRN-BLK-YEL)
R3-470 (YEL-VIO-BRN)

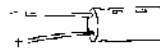
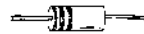

C1-100 UF

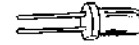

RED LED



CIRCUIT DIAGRAM

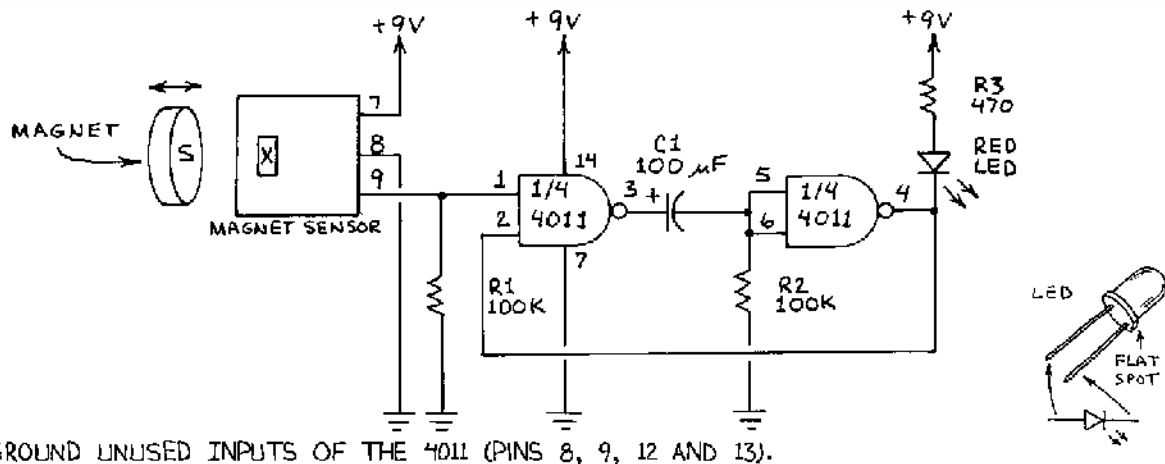

GROUND UNUSED INPUTS OF THE 4011 (PINS 8, 9, 12 AND 13).

1. BUILD THE CIRCUIT

- | | |
|--|--|
| 1. <input type="checkbox"/> PUSH POWER AND DISPLAY SWITCHES OFF. | 9. <input type="checkbox"/> CONNECT F10 TO +9V (WHT). |
| 2. <input type="checkbox"/> INSERT 4011 IC ACROSS SLOT (PIN 1 AT F5). | 10. <input type="checkbox"/> CONNECT G2 TO I2 (WHT). |
| 3. <input type="checkbox"/> INSERT R1 ACROSS F2 AND L2. | 11. <input type="checkbox"/> CONNECT J1 TO K1 (WHT). |
| 4. <input type="checkbox"/> INSERT R2 ACROSS K4 AND GROUND. | 12. <input type="checkbox"/> CONNECT L7 TO GROUND (WHT). |
| 5. <input type="checkbox"/> INSERT R3 ACROSS E1 AND +9V. | 13. <input type="checkbox"/> CONNECT G10 TO H10 (WHT). |
| 6. <input type="checkbox"/> INSERT C1 ACROSS H4 (+) AND J4 (-). | 14. <input type="checkbox"/> CONNECT K10 TO L10 (WHT). |
| 7. <input type="checkbox"/> INSERT LED ACROSS E4 (ANODE) AND G4 (CATHODE). | 15. <input type="checkbox"/> CONNECT H9 TO K9 (WHT). |
| 8. <input type="checkbox"/> CONNECT L1 TO GROUND (WHT). | 16. <input type="checkbox"/> CONNECT SPRING 7 TO +9V (RED). |
| | 17. <input type="checkbox"/> CONNECT SPRING 8 TO GROUND (RED). |
| | 18. <input type="checkbox"/> CONNECT SPRING 9 TO F1 (RED). |

2. TEST THE CIRCUIT

CHECK YOUR WIRING FOR ERRORS. THE LEADS OF SEVERAL OF THE PARTS ARE CLOSELY SPACED, SO BE SURE THEY DO NOT TOUCH ONE ANOTHER. PUSH THE POWER SWITCH ON AND THE LED GLOWS. AFTER SEVERAL SECONDS, THE LED SWITCHES OFF. NOW BRING THE SOUTH POLE OF THE MAGNET NEAR THE LEFT SIDE OF THE MAGNET SENSOR. THE LED SWITCHES ON FOR SEVERAL SECONDS. DURING THIS PERIOD, MOVING THE MAGNET AWAY FROM THE MAGNET SENSOR WILL HAVE NO EFFECT ON THE CIRCUIT, AND THE LED WILL CONTINUE TO GLOW.

3. GOING FURTHER

C1 AND R2 CONTROL HOW LONG THE LED STAYS ON ONCE THE MAGNET SENSOR IS TRIGGERED. FOR BRIEF TIME DELAYS, REPLACE C1 WITH A 10 UF CAPACITOR. FOR LONG TIME DELAYS, REPLACE C1 WITH THE 470 UF CAPACITOR. ORIENT THE CAPACITOR LEADS CORRECTLY (H4 IS + AND J4 IS -).

USE A MAGNET TO SWITCH ON A FLASHING LED

YOU WILL BUILD AN LED FLASHER CIRCUIT THAT IS TRIGGERED BY THE MAGNET. NORMALLY A RED LED GLOWS STEADILY. WHEN THE MAGNET IS PLACED NEAR THE MAGNET SENSOR, THE LED FLASHES A FEW TIMES EACH SECOND.

PARTS YOU WILL NEED

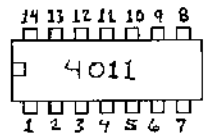

- R1-1M (BRN-BLK-GRN)
- R2-100K (BRN-BLK-YEL)
- R3 470 (YEL VIO BRN)

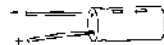

C1-1 UF

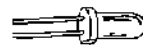

RED LED



CIRCUIT DIAGRAM

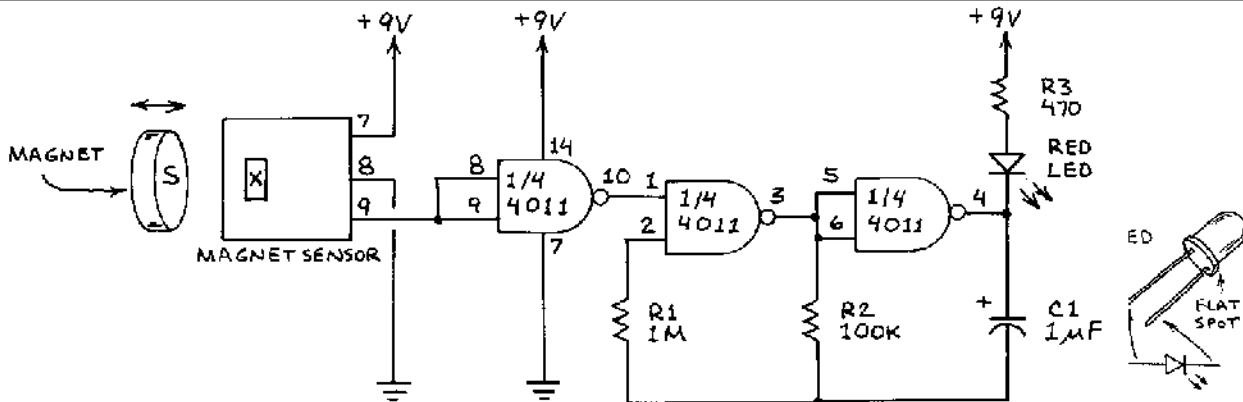

GROUND UNUSED INPUTS OF THE 4011 (PINS 12 AND 13).

1. BUILD THE CIRCUIT

- | | |
|--|--|
| <ol style="list-style-type: none"> 1. <input type="checkbox"/> PUSH POWER AND DISPLAY SWITCHES OFF. 2. <input type="checkbox"/> INSERT 4011 IC ACROSS SLOT (PIN 1 AT F5). 3. <input type="checkbox"/> INSERT R1 ACROSS D3 AND G3. 4. <input type="checkbox"/> INSERT R2 ACROSS D5 AND H4. 5. <input type="checkbox"/> INSERT R3 ACROSS E1 AND +9V. 6. <input type="checkbox"/> INSERT C1 ACROSS I4 (+) AND D4 (-). 7. <input type="checkbox"/> INSERT LED ACROSS E2 (ANODE) AND I2 (CATHODE). 8. <input type="checkbox"/> CONNECT L2 TO GROUND (WHT). 9. <input type="checkbox"/> CONNECT F10 TO +9V (WHT). | <ol style="list-style-type: none"> 10. <input type="checkbox"/> CONNECT H2 TO J2 (WHT). 11. <input type="checkbox"/> CONNECT J1 TO K1 (WHT). 12. <input type="checkbox"/> CONNECT L4 TO H7 (WHT). 13. <input type="checkbox"/> CONNECT F4 TO J7 (WHT). 14. <input type="checkbox"/> CONNECT G10 TO H10 (WHT). 15. <input type="checkbox"/> CONNECT K10 TO L10 (WHT). 16. <input type="checkbox"/> CONNECT SPRING 7 TO +9V (RED). 17. <input type="checkbox"/> CONNECT SPRING 8 GROUND (RED). 18. <input type="checkbox"/> CONNECT SPRING 9 TO L7 (RED). |
|--|--|

2. TEST THE CIRCUIT

INSPECT YOUR CIRCUIT FOR ERRORS. THE LEADS OF THE LED, C1, AND ALL 3 RESISTORS ARE VERY CLOSE TOGETHER. SPREAD THESE COMPONENTS OUTWARD SO THEIR LEADS DO NOT TOUCH ONE ANOTHER, PUSH THE POWER SWITCH ON, AND THE RED LED WILL GLOW. WHEN YOU PLACE THE SOUTH POLE OF THE MAGNET NEAR THE LEFT SIDE OF THE MAGNET SENSOR, THE LED FLASHES SEVERAL TIMES EACH SECOND. MOVE THE MAGNET AWAY, AND THE LED GLOWS CONTINUOUSLY.

3. GOING FURTHER

TO SLOW THE LED FLASH RATE, INCREASE C1 TO 4.7 OR 10 UF. ORIENT THE CAPACITOR LEADS CORRECTLY (I4 IS - AND D4 IS -) OR REPLACE R2 (BRN-BLK-YEL) WITH THE 1M CONSOLE POT. CONNECT SPRING 16 TO D5 (BLU) AND SPRING 17 TO H4 (BLU). ROTATE THE 1M POT KNOB TO CHANGE THE FLASH RATE WHEN THE MAGNET IS NEAR THE MAGNET SENSOR.

USE A MAGNET TO STOP A FLASHING LED

YOU WILL MODIFY THE CIRCUIT ON PAGE 46 TO BUILD AN LED FLASHER CIRCUIT THAT IS SWITCHED OFF BY THE MAGNET. NORMALLY A RED LED FLASHES SEVERAL TIMES A SECOND. WHEN THE MAGNET IS PLACED NEAR THE MAGNET SENSOR, THE LED STOPS FLASHING AND GLOWS STEADILY.

PARTS YOU WILL NEED

THIS CIRCUIT IS A MODIFIED VERSION OF THE ONE ON PAGE 46. NO ADDITIONAL PARTS ARE NECESSARY.

CIRCUIT DIAGRAM

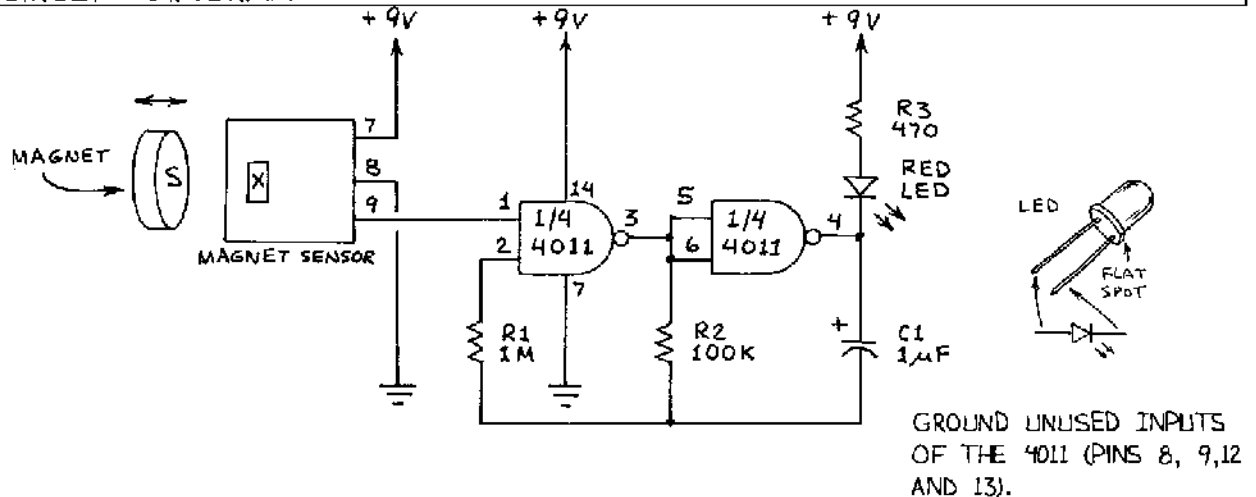

1. MODIFY THE CIRCUIT THAT USES A MAGNET TO SWITCH ON A FLASHING LED

1. PUSH POWER AND DISPLAY SWITCHES OFF. 3. MOVE RED WIRE AT L7 TO F1.
2. REMOVE WHT WIRE BETWEEN F4 AND J7. 4. CONNECT K9 TO H9 (WHT).

2. TEST THE CIRCUIT

THIS IS A MODIFIED CIRCUIT, SO BE SURE NONE OF THE PARTS OR WIRES HAVE COME LOOSE AND THAT YOU HAVE MADE NO ERRORS. PUSH THE POWER SWITCH UP, AND THE LED WILL FLASH SEVERAL TIMES EACH SECOND. NOW PLACE THE SOUTH POLE OF THE MAGNET NEAR THE LEFT SIDE OF THE MAGNET SENSOR. THE LED WILL GLOW STEADILY.

3. GOING FURTHER

AS WITH THE ORIGINAL CIRCUIT, YOU CAN INCREASE THE VALUE OF C1 TO SLOW THE FLASH RATE. YOU CAN ALSO REPLACE R2 WITH THE 1M CONSOLE POTENTIOMETER TO PROVIDE AN ADJUSTABLE FLASH RATE. SEE PAGE 46 FOR DETAILS.

YOU CAN ADD A SECOND LED TO MAKE AN ALTERNATE RED-GREEN FLASHER. YOU WILL NEED A GREEN LED AND R4, A 470-OHM RESISTOR (YEL-VO-BRN). FOLLOW THESE STEPS:

1. PUSH POWER AND DISPLAY SWITCHES OFF. 5. INSERT LED ACROSS E7 (ANODE) AND
2. REMOVE WHT WIRE BETWEEN K9 AND H9. J7 (CATHODE).
3. REMOVE WHT WIRE BETWEEN L4 AND H7. 6. CONNECT I8 TO I3 (WHT).
4. INSERT R4 ACROSS E8 AND +9V. 7. CONNECT H9 TO L4 (WHT).

PUSH THE POWER SWITCH ON, AND THE LEDS WILL FLASH ALTERNATELY. PLACE THE SOUTH POLE OF THE MAGNET NEAR THE LEFT SIDE OF THE MAGNET SENSOR. THE GREEN LED WILL STOP FLASHING AND THE RED LED WILL GLOW CONTINUOUSLY.

USE THE MAGNET TO SWITCH ON A TONE

YOU WILL USE THE MAGNET TO ACTIVATE AN ADJUSTABLE AUDIO OSCILLATOR MADE FROM TWO GATES IN A 4011.

PARTS YOU WILL NEED

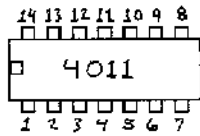

R1-100K (BRN-BLK-YEL)
R2-1M (BRN-BLK-GRN)

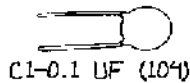
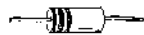

C1-0.1 UF (104)



CIRCUIT DIAGRAM

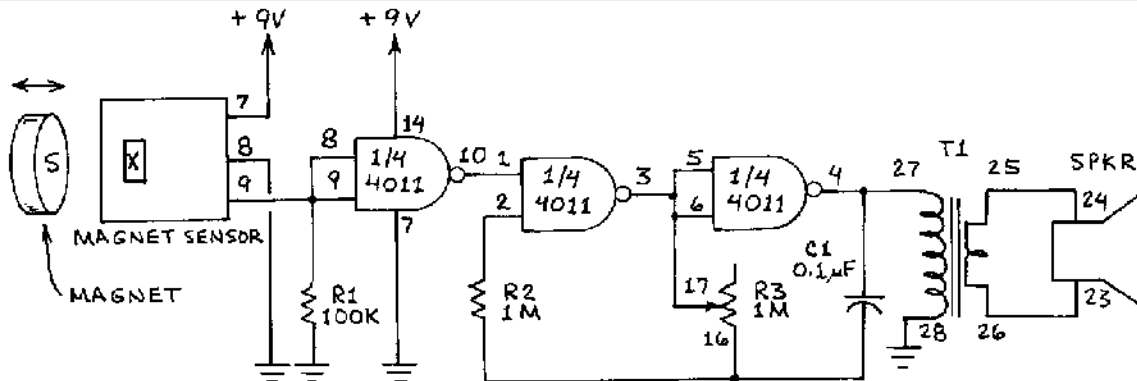

GROUND UNUSED INPUTS OF THE 4011 (PINS 12 AND 13).

1. BUILD THE CIRCUIT

- | | |
|--|--|
| <ol style="list-style-type: none"> 1. <input type="checkbox"/> PUSH POWER AND DISPLAY SWITCHES OFF. 2. <input type="checkbox"/> INSERT 4011 IC ACROSS SLOT (PIN 1 AT F5). 3. <input type="checkbox"/> INSERT R2 ACROSS D3 AND G3. 4. <input type="checkbox"/> INSERT R1 ACROSS L9 AND GROUND. 5. <input type="checkbox"/> INSERT C1 ACROSS I4 AND D4. 6. <input type="checkbox"/> CONNECT L1 TO GROUND (WHT). 7. <input type="checkbox"/> CONNECT F30 TO +9V (WHT). 8. <input type="checkbox"/> CONNECT H2 TO J2 (WHT). 9. <input type="checkbox"/> CONNECT J1 TO K1 (WHT). 10. <input type="checkbox"/> CONNECT F4 TO J7 (WHT). 11. <input type="checkbox"/> CONNECT L4 TO H7 (WHT). | <ol style="list-style-type: none"> 12. <input type="checkbox"/> CONNECT G10 TO H10 (WHT). 13. <input type="checkbox"/> CONNECT K10 TO L10 (WHT). 14. <input type="checkbox"/> CONNECT SPRING 7 TO +9V (RED). 15. <input type="checkbox"/> CONNECT SPRING 8 GROUND (RED). 16. <input type="checkbox"/> CONNECT SPRING 9 TO L7 (RED). 17. <input type="checkbox"/> CONNECT SPRING 16 TO D5 (BLU). 18. <input type="checkbox"/> CONNECT SPRING 17 TO K4 (BLU). 19. <input type="checkbox"/> CONNECT SPRINGS 23 AND 26 (RED). 20. <input type="checkbox"/> CONNECT SPRINGS 24 AND 25 (WHT). 21. <input type="checkbox"/> CONNECT SPRING 27 TO I3 (BLU). 22. <input type="checkbox"/> CONNECT SPRING 28 TO GROUND (RED). |
|--|--|

2. TEST THE CIRCUIT

CHECK YOUR WIRING FOR ERRORS. PUSH THE POWER SWITCH ON. THE SPEAKER IS SILENT. NOW HOLD THE SOUTH POLE OF THE MAGNET NEAR THE LEFT SIDE OF THE MAGNET SENSOR. YOU WILL HEAR A BUZZ OR TONE FROM THE SPEAKER. ADJUST 1M CONSOLE POT R3 TO CHANGE THE FREQUENCY OF THE SOUND.

3. GOING FURTHER

YOU CAN MAKE THE FREQUENCY OF THE TONE RESPOND TO LIGHT. FOLLOW THESE STEPS:

1. PUSH POWER AND DISPLAY SWITCHES OFF.
2. INSERT PHOTORESISTOR CARD IN SENSOR SOCKET.
3. MOVE BLU AT SPRING 16 TO SPRING 1.
4. MOVE BLU AT SPRING 17 TO SPRING 2.

PUSH THE POWER SWITCH ON AND PLACE THE SOUTH POLE OF THE MAGNET NEAR THE LEFT SIDE OF THE MAGNET SENSOR. THE SPEAKER EMITS A TONE THAT INCREASES IN FREQUENCY WHEN THE LIGHT LEVEL AT THE PHOTORESISTOR INCREASES.

USE THE MAGNET TO SWITCH OFF A TONE

YOU WILL MODIFY THE CIRCUIT ON PAGE 48 SO THAT AN AUDIO TONE IS SWITCHED OFF WHEN THE MAGNET IS PLACED NEAR THE MAGNET SENSOR.

PARTS YOU WILL NEED

THIS CIRCUIT IS A MODIFIED VERSION OF THE ONE ON PAGE 48. NO ADDITIONAL PARTS ARE NECESSARY.

CIRCUIT DIAGRAM

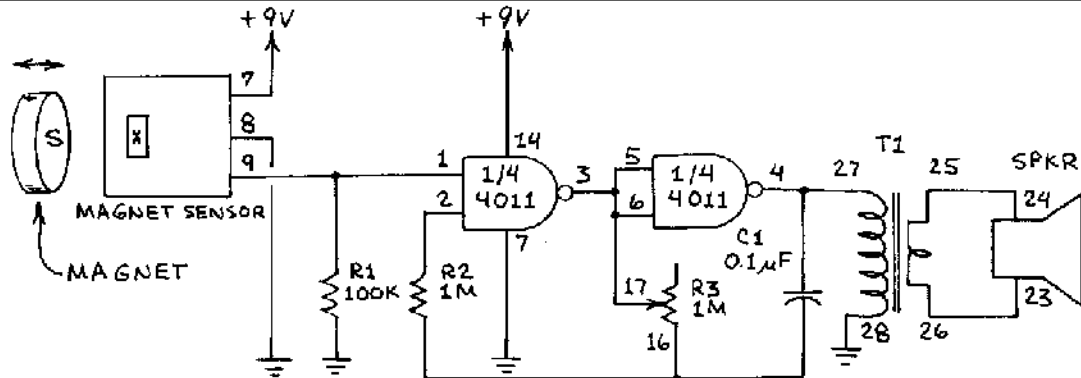

- GROUND UNUSED INPUTS OF 4011 (PINS 8, 9, 12 AND 13).

1. MODIFY CIRCUIT THAT USES A MAGNET TO SWITCH ON A TONE

1. PUSH POWER AND DISPLAY SWITCHES OFF.
2. REMOVE WHT WIRE BETWEEN F4 AND J7.
3. MOVE RED WIRE AT L7 TO F3.
4. CONNECT H9 TO K9 (WHT).

2. TEST THE CIRCUIT

ANY TIME YOU MODIFY A CIRCUIT, IT IS IMPORTANT TO MAKE SURE NONE OF THE WIRES OR PARTS HAVE COME LOOSE. BE SURE TO CHECK YOUR WIRING CAREFULLY. PUSH THE POWER SWITCH ON AND YOU WILL HEAR A TONE FROM THE SPEAKER. PLACE THE SOUTH POLE OF THE MAGNET NEAR THE LEFT SIDE OF THE MAGNET SENSOR, AND THE TONE WILL STOP.

THE OPERATION OF THIS CIRCUIT RESEMBLES THAT OF THE CIRCUIT ON PAGE 44 IN WHICH THE MAGNET SWITCHES OFF THE BUZZER. THE MAIN DIFFERENCES ARE THAT THIS CIRCUIT USES LESS CURRENT AND THE FREQUENCY OF THE AUDIO TONE CAN BE ADJUSTED. AS WITH THE CIRCUIT ON PAGE 44, THIS CIRCUIT CAN SIMULATE THE OPERATION OF AN INTRUSION ALARM DESIGNED TO DETECT AN OPEN WINDOW OR DOOR. IN EITHER CASE, THE MAGNET IS MOUNTED ON THE MOVING OBJECT AND THE MAGNET SENSOR IS ON A NEARBY FIXED OBJECT.

A SIMILAR APPROACH CAN BE USED TO DETECT WHEN MERCHANDISE IN A STORE OR AN OBJECT IN A MUSEUM HAS BEEN MOVED. THE MAGNET IS MOUNTED AT THE BOTTOM OF THE OBJECT BEING PROTECTED. THE MAGNET SENSOR IS MOUNTED BELOW WHERE THE OBJECT IS PLACED. THE TONE SOUNDS WHEN THE OBJECT IS MOVED.

3. GOING FURTHER

THIS CIRCUIT CAN BE USED TO DETECT FERROUS METALS LIKE IRON AND STEEL. HOLD THE MAGNET NEAR THE MAXIMUM RANGE AWAY FROM THE MAGNET SENSOR AT WHICH THE TONE IS SILENT. THEN PLACE ONE END OF THE PAPER CLIP AGAINST THE LEFT SIDE OF THE MAGNET SENSOR. THE TONE SOUNDS WHEN THE PAPER CLIP IS DIRECTLY BETWEEN THE CENTER OF THE MAGNET SENSOR AND THE MAGNET. RUB THE PAPER CLIP AND THE TONE SWITCHES OFF AND ON. GRIP THE PAPER CLIP FIRMLY, SINCE IT WILL BE ATTRACTED TO THE MAGNET.

USE A MAGNET TO CONTROL A PULSATING TONE GENERATOR

YOU WILL USE ALL FOUR GATES IN A 4011 TO BUILD A PAIR OF AUDIO OSCILLATORS THAT GENERATE A PULSATING TONE. YOU WILL USE THE MAGNET TO SWITCH THE TONE OFF.

PARTS YOU WILL NEED

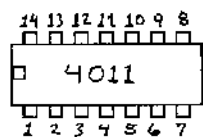

R1-1M (BRN-BLK-GRN)

C1-10 UF

C2-0.01 UF (103)



CIRCUIT DIAGRAM

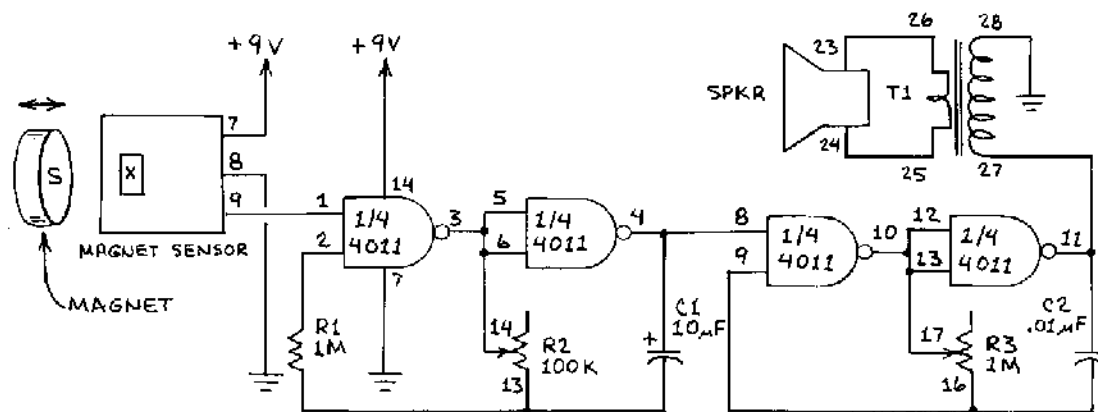

1. BUILD THE CIRCUIT

- | | |
|---|---|
| 1. <input type="checkbox"/> PUSH POWER AND DISPLAY SWITCHES OFF. | 13. <input type="checkbox"/> CONNECT SPRING 7 TO +9V (RED). |
| 2. <input type="checkbox"/> INSERT 4011 IC ACROSS SLOT (PIN 1 AT F5). | 14. <input type="checkbox"/> CONNECT SPRING 8 TO GROUND (RED). |
| 3. <input type="checkbox"/> INSERT R1 ACROSS G4 AND D4. | 15. <input type="checkbox"/> CONNECT SPRING 9 TO F1 (RED). |
| 4. <input type="checkbox"/> INSERT C1 ACROSS I3 (+) AND D3 (-). | 16. <input type="checkbox"/> CONNECT SPRING 13 TO D1 (BLU). |
| 5. <input type="checkbox"/> INSERT C2 ACROSS I7 AND K7. | 17. <input type="checkbox"/> CONNECT SPRING 14 TO H1 (BLU). |
| 6. <input type="checkbox"/> CONNECT L1 TO GROUND (WHT). | 18. <input type="checkbox"/> CONNECT SPRING 16 TO K10 (BLU). |
| 7. <input type="checkbox"/> CONNECT F10 TO +9V (WHT). | 19. <input type="checkbox"/> CONNECT SPRING 17 TO J10 (BLU). |
| 8. <input type="checkbox"/> CONNECT J1 TO K1 (WHT). | 20. <input type="checkbox"/> CONNECT SPRINGS 23 AND 26 (RED). |
| 9. <input type="checkbox"/> CONNECT H2 TO J2 (WHT). | 21. <input type="checkbox"/> CONNECT SPRINGS 24 AND 25 (WHT). |
| 10. <input type="checkbox"/> CONNECT G10 TO H10 (WHT). | 22. <input type="checkbox"/> CONNECT SPRING 27 TO I8 (BLU). |
| 11. <input type="checkbox"/> CONNECT H9 TO J9 (WHT). | 23. <input type="checkbox"/> CONNECT SPRING 28 TO GROUND (RED). |
| 12. <input type="checkbox"/> CONNECT I4 TO L7 (WHT). | |

2. TEST THE CIRCUIT

REVIEW WIRING FOR ERRORS. PUSH THE POWER SWITCH ON. A PULSATING TONE SOUNDS. ADJUST 100K CONSOLE POT R2 AND 1M POT R3 TO CONTROL THE RATE AND FREQUENCY OF THE TONE. PLACE THE SOUTH POLE OF THE MAGNET NEAR THE LEFT SIDE OF THE MAGNET SENSOR. THE TONE STOPS. REMOVE THE MAGNET AND THE TONE RESUMES.

3. GOING FURTHER

- | | |
|--|--|
| 1. <input type="checkbox"/> PUSH POWER AND DISPLAY SWITCHES OFF. | 3. <input type="checkbox"/> MOVE BLU AT SPRING 13 TO SPRING 1. |
| 2. <input type="checkbox"/> INSERT PHOTORESISTOR CARD IN SOCKET. | 4. <input type="checkbox"/> MOVE BLU AT SPRING 14 TO SPRING 2. |

TO MAKE THE CIRCUIT RESPOND TO LIGHT, PUSH THE POWER SWITCH ON AND SHADE THE PHOTORESISTOR CARD. PLACE THE MAGNET'S SOUTH POLE NEAR THE LEFT SIDE OF THE MAGNET SENSOR. THE TONE FREQUENCY WITHIN THE PULSES INCREASES WHEN THE LIGHT AT THE PHOTORESISTOR INCREASES. NOTE THAT TOO MUCH LIGHT MAY STOP THE TONE.

USE THE MAGNET TO TRIGGER TWO TONES

YOU WILL CONNECT THE MAGNET SENSOR TO THE VOLTAGE INPUT PIN OF A 555 TIMER IC CONNECTED AS AN AUDIO OSCILLATOR. YOU WILL THEN USE THE MAGNET TO CHANGE THE FREQUENCY OF THE TONE FROM A HIGH FREQUENCY TO A LOW FREQUENCY.

PARTS YOU WILL NEED

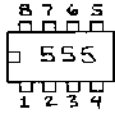

R2-10K (BRN-BLK-ORG)
R3-150 (BRN-GRN-BRN)



C1-0.1 uF (104)



CIRCUIT DIAGRAM

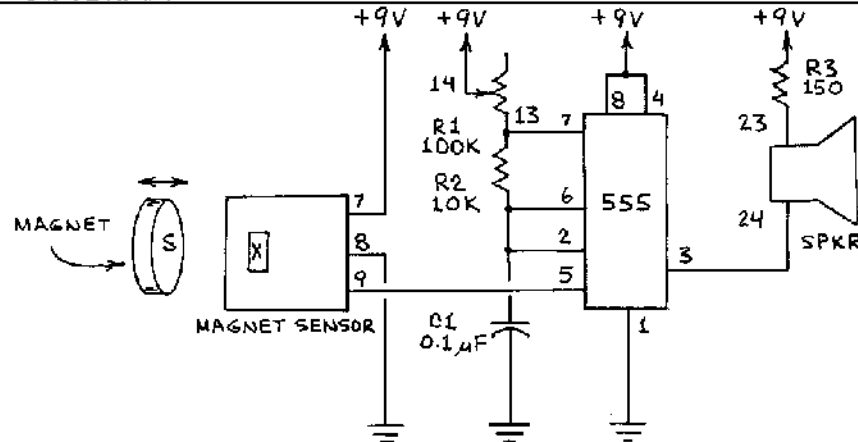

1. BUILD THE CIRCUIT

1. PUSH POWER AND DISPLAY SWITCHES OFF.
2. INSERT 555 IC ACROSS SLOT (PIN 1 AT Q5).
3. INSERT R2 ACROSS SPRING R10 AND S10.
4. INSERT R3 ACROSS SPRING 23 AND +9V.
5. INSERT C1 ACROSS Q1 AND R1.
6. CONNECT Q3 AND GROUND (WHT).
7. CONNECT Q10 TO +9V (RED).
8. CONNECT R4 AND S7 (WHT).
9. CONNECT T4 AND Q7 (WHT).
10. CONNECT SPRING 7 TO +9V (RED).
11. CONNECT SPRING 8 TO GROUND (RED).
12. CONNECT SPRING 9 TO T7 (RED).
13. CONNECT SPRING 13 TO R9 (BLU).
14. CONNECT SPRING 14 TO +9V (BLU).
15. CONNECT SPRING 24 TO S4 (RED).

2. TEST THE CIRCUIT

INSPECT THE CIRCUIT FOR ERRORS. ADJUST 100K CONSOLE POT R1 TO ITS MID-POINT AND PUSH THE POWER SWITCH ON. A BUZZ OR TONE SOUNDS FROM THE SPEAKER. PLACE THE SOUTH POLE OF THE MAGNET NEAR THE LEFT SIDE OF THE MAGNET SENSOR. THE FREQUENCY OF THE TONE SUDDENLY CHANGES. MOVE THE MAGNET AWAY, AND THE FREQUENCY RETURNS TO ITS FORMER VALUE. WITH THE MAGNET MOVED AWAY FROM THE MAGNET SENSOR, ADJUST 100K CONSOLE POT R1 FOR THE DESIRED TONE FREQUENCY. REPEAT THE MAGNET EXPERIMENT. ROTATE R1 TO THE RIGHT, AND THE TONE HAS A HIGH FREQUENCY. WHEN YOU BRING THE MAGNET CLOSE TO THE MAGNET SENSOR, THE TONE STOPS.

3. GOING FURTHER

1. PUSH POWER AND DISPLAY SWITCHES OFF.
 2. INSERT PHOTORESISTOR CARD IN SOCKET.
 3. MOVE BLU AT SPRING 13 TO SPRING 1.
 4. MOVE BLU AT SPRING 14 TO SPRING 2.
- PLACE THE CIRCUIT IN A DARKENED ROOM. PUSH THE POWER SWITCH ON AND PLACE THE SOUTH POLE OF THE MAGNET NEAR THE LEFT SIDE OF THE MAGNET SENSOR. THE SPEAKER EMITS A TONE THAT INCREASES IN FREQUENCY WHEN THE PHOTORESISTOR LIGHT LEVEL INCREASES.

USE THE TOUCH SENSOR TO SWITCH OFF AN LED

YOU WILL BUILD A SIMPLE TOUCH SWITCH FROM ONLY ONE GATE IN A 4011 QUAD NAND GATE. NORMALLY AN LED WILL GLOW. TOUCHING THE TOUCH SENSOR EXTINGUISHES THE LED. THE CIRCUIT INCLUDES A PAIR OF 100,000 OHM RESISTORS (R1 AND R2) TO HELP PROTECT THE CMOS GATE FROM POSSIBLE DAMAGE CAUSED BY ELECTROSTATIC DISCHARGE.

PARTS YOU WILL NEED

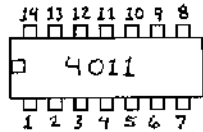

- R1, R2-100K (BRN-BLK-YEL)
- R3 10M (BRN BLK BLU)
- R4-470 (YEL-VIO-BRN)



CIRCUIT DIAGRAM

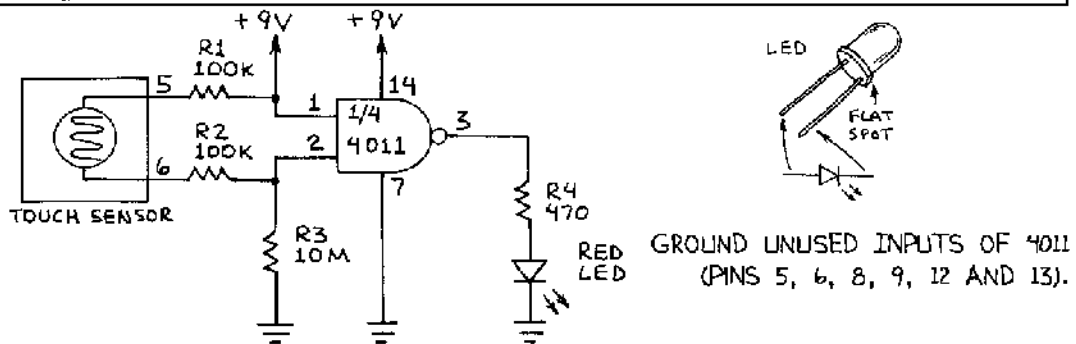

1. BUILD THE CIRCUIT

- | | |
|---|--|
| <ol style="list-style-type: none"> 1. <input type="checkbox"/> PUSH POWER AND DISPLAY SWITCHES OFF. 2. <input type="checkbox"/> INSERT 4011 IC ACROSS SLOT (PIN 1 AT F5). 3. <input type="checkbox"/> INSERT R1 ACROSS SPRING 5 AND F1. 4. <input type="checkbox"/> INSERT R2 ACROSS SPRING 6 AND G1. 5. <input type="checkbox"/> INSERT R3 ACROSS G4 AND L7. 6. <input type="checkbox"/> INSERT R4 ACROSS H3 AND N3. 7. <input type="checkbox"/> INSERT LED ACROSS N4 (ANODE) AND L4 (CATHODE). | <ol style="list-style-type: none"> 8. <input type="checkbox"/> CONNECT L1 TO GROUND (WHT). 9. <input type="checkbox"/> CONNECT F7 TO +9V (WHT). 10. <input type="checkbox"/> CONNECT F4 TO +9V (WHT). 11. <input type="checkbox"/> CONNECT J1 TO K1 (WHT). 12. <input type="checkbox"/> CONNECT K2 TO L2 (WHT). 13. <input type="checkbox"/> CONNECT G10 TO H10 (WHT). 14. <input type="checkbox"/> CONNECT K10 TO L10 (WHT). 15. <input type="checkbox"/> CONNECT H9 TO K9 (WHT). 16. <input type="checkbox"/> CONNECT L9 TO GROUND (WHT). |
|---|--|

2. TEST THE CIRCUIT

CHECK YOUR WIRING FOR ERRORS AND BE SURE THAT ALL THE UNUSED INPUTS ARE CONNECTED TO GROUND. DISCHARGE ANY STATIC ELECTRICAL CHARGE ON YOUR BODY BY TOUCHING A GROUNDED METAL OBJECT, SUCH AS A SCREW ON AN ELECTRICAL LIGHT SWITCH PLATE. PUSH THE POWER SWITCH ON. THE LED GLOWS. PRESS THE TOUCH SENSOR WITH YOUR INDEX FINGER. THE LED SWITCHES OFF. REMOVE YOUR FINGER, AND THE LED GLOWS AGAIN. NOTICE THAT THE LED CONTINUES TO GLOW UNTIL YOU PRESS DOWN WITH YOUR FINGER. TRY VARYING THE PRESSURE ON THE TOUCH SWITCH AND THE ANGLE OF YOUR FINGER TO SEE IF YOU CAN DIM THE LED INSTEAD OF SWITCHING IT OFF ABRUPTLY. A VERY GENTLE TOUCH ALLOWS YOU TO DO THIS.

3. GOING FURTHER

LATER IN THIS MANUAL (PP. 62-67) YOU WILL INSERT THE CONDUCTIVE FOAM CYLINDER INTO THE TOUCH SENSOR TO CONVERT IT TO A PRESSURE SENSOR. YOU CAN ALSO USE THE PRESSURE SENSOR WITH THIS TOUCH SENSOR PROJECT. INSERT THE FOAM PLASTIC PRESSURE SENSOR INTO THE TOUCH SENSOR APERTURE AND PRESS DOWN. THE LED SWITCHES OFF.

USE THE TOUCH SENSOR TO SWITCH ON AN LED

YOU WILL ADD A GATE TO THE CIRCUIT ON PAGE 52 TO BUILD A TOUCH SWITCH THAT SWITCHES ON AN LED. NORMALLY THE LED IS OFF. TOUCHING THE TOUCH SENSOR CAUSES THE LED TO GLOW. THE CIRCUIT RETAINS THE PAIR OF 100,000 OHM RESISTORS (R1 AND R2) THAT HELP PROTECT THE CMOS GATE FROM ELECTROSTATIC DISCHARGE.

PARTS YOU WILL NEED

THIS CIRCUIT IS A MODIFIED VERSION OF THE ONE ON PAGE 52. NO ADDITIONAL PARTS ARE NECESSARY.

CIRCUIT DIAGRAM

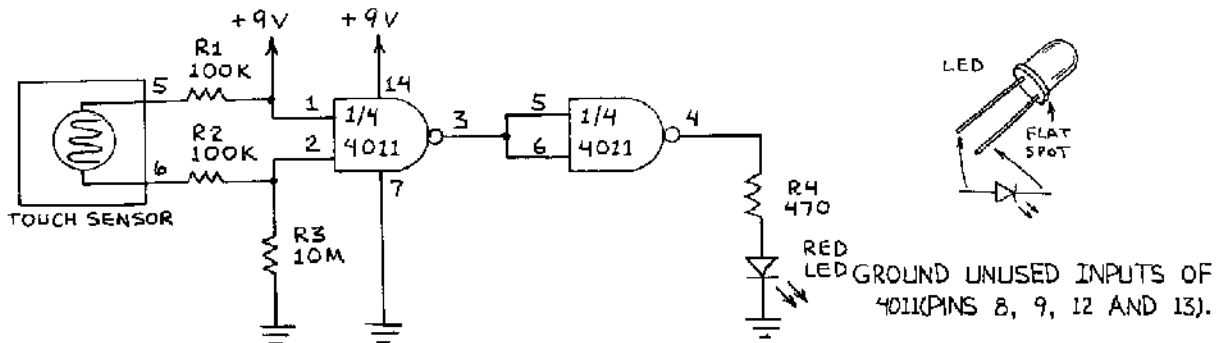

1. MODIFY THE TOUCH SWITCH THAT SWITCHES OFF AN LED (P. 52)

- PUSH POWER AND DISPLAY SWITCHES OFF.
- REMOVE R4 ACROSS H3 AND N3.
- REMOVE WHT WIRE ACROSS K2 AND L2.
- INSERT R4 ACROSS I3 AND N3.
- CONNECT H2 TO J2 (WHT).

2. TEST THE CIRCUIT

BECAUSE THIS CIRCUIT HAS BEEN MODIFIED FROM A PREVIOUS PROJECT, IT'S ESPECIALLY IMPORTANT TO MAKE SURE NO WIRES OR PARTS HAVE COME LOOSE. CHECK YOUR WIRING CAREFULLY. IF YOU HAVEN'T ALREADY DONE SO, DISCHARGE ANY STATIC ELECTRICAL CHARGE ON YOUR BODY BY TOUCHING A GROUNDED METAL OBJECT, SUCH AS A SCREW ON AN ELECTRICAL LIGHT SWITCH PLATE.

PUSH THE POWER SWITCH ON. THE LED WILL BE OFF. PRESS YOUR INDEX FINGER AGAINST THE TOUCH SENSOR. THE LED WILL GLOW. REMOVE YOUR FINGER, AND THE LED WILL SWITCH OFF. EXPERIMENT WITH THE ANGLE OF YOUR FINGER FOR BEST RESULTS.

3. GOING FURTHER

AS WITH THE PROJECT ON PAGE 52, YOU CAN USE THE PRESSURE SENSOR WITH THIS TOUCH SENSOR PROJECT. JUST INSERT THE FOAM PLASTIC PRESSURE SENSOR INTO THE TOUCH SENSOR APERTURE AND PRESS DOWN GENTLY. THE LED WILL GLOW. NOTICE THAT THE CIRCUIT IS VERY SENSITIVE TO TOUCH WHEN OPERATED WITH THE PRESSURE-SENSITIVE FOAM.

YOU HAVE PROBABLY ALREADY NOTICED THAT YOU CAN SWITCH THE LED ON BY SIMPLY TOUCHING THE TOUCH SENSOR SPRINGS INSTEAD OF THE TOUCH SENSOR ITSELF. YOU CAN ALSO BRIDGE YOUR INDEX FINGER ACROSS THE LEADS OF R1 AND R2. IT'S BEST TO TOUCH THE LEADS OF R1 AND R2 THAT MAKE CONTACT WITH SPRINGS 5 AND 6. TOUCHING THE LEADS THAT ARE CONNECTED DIRECTLY TO THE INPUTS OF THE 4011 GATE MAY INTRODUCE STATIC ELECTRICITY THAT CAN DAMAGE THE GATE.

USE THE TOUCH SENSOR TO SWITCH OFF A TONE

YOU WILL BUILD A SIMPLE TOUCH SWITCH AND AN AUDIO TONE GENERATOR FROM THREE GATES IN A 4011 QUAD NAND GATE. NORMALLY THE TONE SOUNDS. TOUCHING YOUR FINGER TO THE TOUCH SENSOR WILL SWITCH OFF THE TONE. THE CIRCUIT INCLUDES A PAIR OF 100,000 OHM RESISTORS (R1 AND R2) TO HELP PROTECT THE CMOS GATE FROM ELECTROSTATIC DISCHARGE.

PARTS YOU WILL NEED

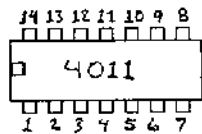

R1, R2 100K (BRN BLK YEL)
R3-10M (BRN-BLK-BLU)

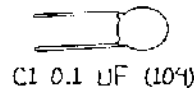

C1 0.1 uF (104)

CIRCUIT DIAGRAM

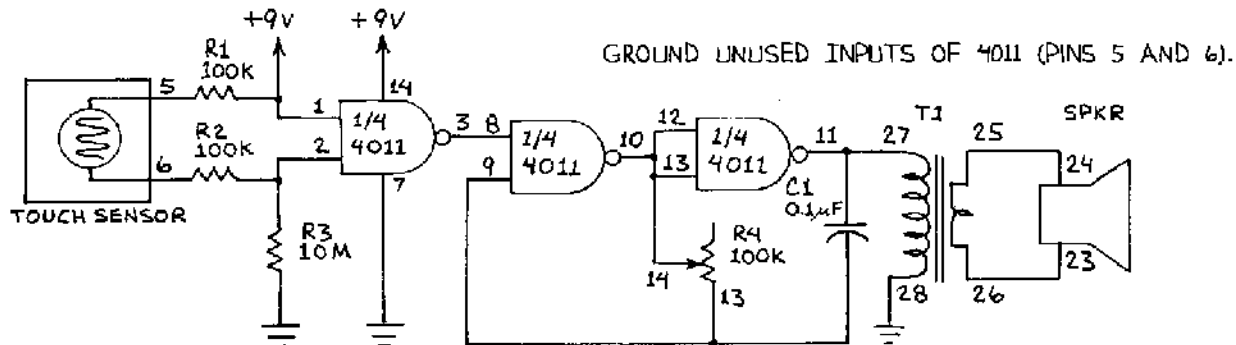

1. BUILD THE CIRCUIT

- | | |
|---|--|
| <ol style="list-style-type: none"> 1. <input type="checkbox"/> PUSH POWER AND DISPLAY SWITCHES OFF. 2. <input type="checkbox"/> INSERT 4011 IC ACROSS SLOT (PIN 1 AT F5). 3. <input type="checkbox"/> INSERT R1 ACROSS SPRING 5 AND F1. 4. <input type="checkbox"/> INSERT R2 ACROSS SPRING 6 AND G1. 5. <input type="checkbox"/> INSERT R3 ACROSS G2 AND L2. 6. <input type="checkbox"/> INSERT C1 ACROSS I10 AND K10. 7. <input type="checkbox"/> CONNECT L1 TO GROUND (WHT). 8. <input type="checkbox"/> CONNECT F10 TO +9V (WHT). 9. <input type="checkbox"/> CONNECT F4 TO +9V (WHT). 10. <input type="checkbox"/> CONNECT H4 TO L7 (WHT). | <ol style="list-style-type: none"> 11. <input type="checkbox"/> CONNECT J1 TO K1 (WHT). 12. <input type="checkbox"/> CONNECT K4 TO GROUND (WHT). 13. <input type="checkbox"/> CONNECT G10 TO H10 (WHT). 14. <input type="checkbox"/> CONNECT H9 TO J9 (WHT). 15. <input type="checkbox"/> CONNECT SPRING 14 TO J8 (BLU). 16. <input type="checkbox"/> CONNECT SPRING 13 TO K8 (BLU). 17. <input type="checkbox"/> CONNECT SPRINGS 24 AND 25 (WHT). 18. <input type="checkbox"/> CONNECT SPRINGS 23 AND 26 (RED). 19. <input type="checkbox"/> CONNECT SPRING 28 TO GROUND (RED). 20. <input type="checkbox"/> CONNECT SPRING 27 TO I8 (BLU). |
|---|--|

2. TEST THE CIRCUIT

THIS CIRCUIT HAS 5 COMPONENTS AND 14 CONNECTION WIRES, SO CAREFULLY CHECK YOUR WIRING FOR ERRORS. BE SURE THAT UNUSED PINS 5 AND 6 OF THE 4011 ARE CONNECTED TO GROUND. DISCHARGE ANY STATIC ELECTRICAL CHARGE ON YOUR BODY BY TOUCHING A GROUNDED METAL OBJECT, SUCH AS A SCREW ON AN ELECTRICAL LIGHT SWITCH PLATE. PUSH THE POWER SWITCH ON, AND YOU HEAR A BUZZ OR TONE. ADJUST THE 100K CONSOLE POT R4 UNTIL YOU LIKE THE SOUND, THEN PRESS THE TOUCH SWITCH. THE TONE CEASES. REMOVE YOUR FINGER, AND THE TONE RETURNS.

3. GOING FURTHER

THIS CIRCUIT IS MORE SENSITIVE TO TOUCH WHEN THE BLACK CONDUCTIVE FOAM PRESSURE SENSOR IS INSERTED INTO THE TOUCH SENSOR APERTURE. THIS IS BECAUSE IT HAS MUCH LESS RESISTANCE THAN THE TIP OF YOUR FINGER.

USE THE TOUCH SENSOR TO SWITCH ON A TONE

YOU WILL ADD A GATE TO THE CIRCUIT ON PAGE 54 TO BUILD A TOUCH SWITCH THAT TURNS ON AN ADJUSTABLE TONE. NORMALLY THE TONE IS OFF. TOUCHING YOUR FINGER TO THE TOUCH SENSOR CAUSES THE TONE TO SOUND. THE CIRCUIT RETAINS THE PAIR OF 100,000 OHM RESISTORS (R1 AND R2) THAT HELP PROTECT THE CMOS GATE FROM ELECTROSTATIC DISCHARGE.

PARTS YOU WILL NEED

THIS CIRCUIT IS A MODIFIED VERSION OF THE ONE ON PAGE 54. NO ADDITIONAL PARTS ARE NECESSARY.

CIRCUIT DIAGRAM

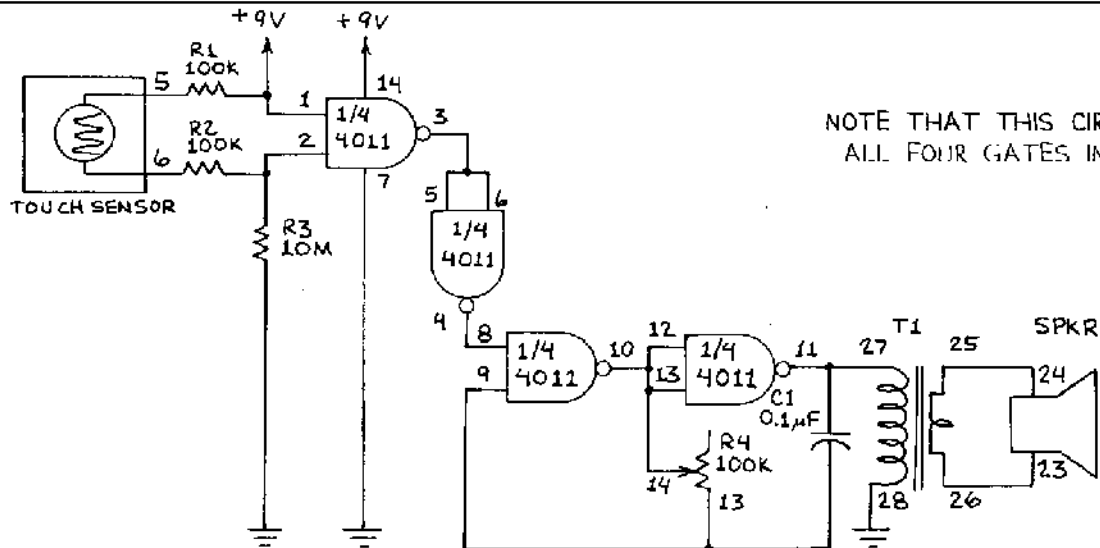

1. MODIFY THE TOUCH SWITCH THAT SWITCHES ON A TONE (P. 54)

1. PUSH POWER AND DISPLAY SWITCHES OFF.
2. REMOVE WHT WIRE ACROSS H4 AND L7.
3. REMOVE WHT WIRE ACROSS K4 AND GROUND.
4. CONNECT H4 TO J4 (WHT).
5. CONNECT I4 TO L7 (WHT).

2. TEST THE CIRCUIT

BECAUSE THIS CIRCUIT HAS BEEN MODIFIED FROM A PREVIOUS PROJECT, IT'S VERY IMPORTANT TO BE CHECK THAT NO WIRES OR PARTS HAVE COME LOOSE. IF YOU HAVEN'T ALREADY DONE SO, DISCHARGE ANY STATIC ELECTRICAL CHARGE ON YOUR BODY BY TOUCHING A GROUNDED METAL OBJECT. PUSH THE POWER SWITCH ON, AND YOU HEAR NOTHING. NOW PRESS YOUR FINGER AGAINST THE TOUCH SENSOR. THE SPEAKER EMITS A TONE. ADJUST 100K CONSOLF POT R4 FOR THE MOST DESIRABLE SOUND WHEN THE SENSOR IS TOUCHED.

3. GOING FURTHER

AS WITH THE CIRCUIT ON PAGE 54, THIS CIRCUIT IS MORE SENSITIVE TO TOUCH WHEN THE BLACK CONDUCTIVE FOAM PRESSURE SENSOR IS INSERTED INTO THE TOUCH SENSOR APERTURE. A VERY LIGHT TOUCH ON THE PRESSURE SENSOR WILL ACTIVATE THE TONE. YOU CAN ALSO CONTROL THE TONE BY PLACING A SMALL WEIGHT ON THE PRESSURE SENSOR. AN INTERESTING EXPERIMENT IS TO TOUCH THE TOUCH SENSOR AFTER SLIGHTLY MOISTENING YOUR FINGERTIP. THE TONE CONTINUES EVEN WHEN YOU REMOVE YOUR FINGER BECAUSE YOUR FINGER DEPOSITS A THIN FILM OF MOISTURE ACROSS THE TOUCH SENSOR ELECTRODES. THIS MOISTURE CONTINUES TO CONDUCT EVEN WHEN YOUR FINGER IS GONE, SO THE TONE REMAINS ON. EVENTUALLY, THE FILM OF MOISTURE EVAPORATES AND THE TONE CEASES.

USE THE TOUCH SENSOR TO KEEP AN LED ON OR OFF

YOU WILL BUILD A TOUCH SWITCH THAT SWITCHES ONE LED ON AND A SECOND LED OFF. THE LEDS REMAIN ON AND OFF FOR A FIXED TIME INTERVAL EVEN AFTER YOU REMOVE YOUR FINGER FROM THE TOUCH SENSOR. THIS CIRCUIT USES THE CONDUCTIVE FOAM PRESSURE SENSOR TO PROVIDE BETTER RESPONSE TO TOUCH.

PARTS YOU WILL NEED

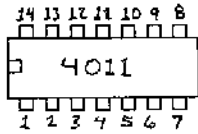

R1, R3-100K (BRN-BLK-YEL)
R2 10M (BRN BLK BLU)
R4, R5-470 (YEL-VIO-BRN)

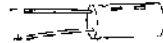

C1 100 UF



GREEN LED
RED LED



PRESSURE SENSOR

CIRCUIT DIAGRAM

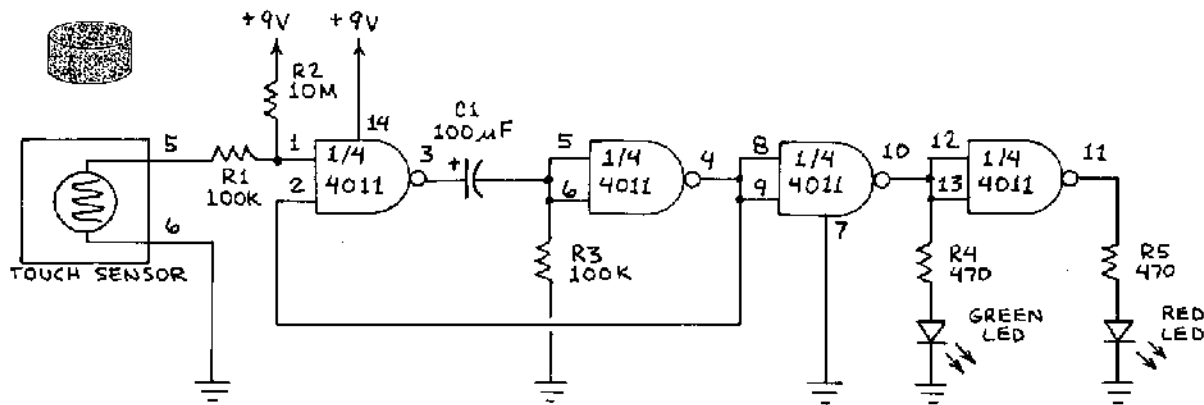

1. BUILD THE CIRCUIT

1. PUSH POWER AND DISPLAY SWITCHES OFF.
2. INSERT 4011 IC ACROSS SLOT (PIN 1 AT F5).
3. INSERT R1 ACROSS SPRING 5 AND F1.
4. INSERT R2 ACROSS F4 AND +9V.
5. INSERT R3 ACROSS K4 AND GROUND.
6. INSERT R4 ACROSS J10 AND S10.
7. INSERT R5 ACROSS I8 AND T7.
8. INSERT C1 ACROSS H2 (+) AND J2 (-).
9. INSERT RED LED ACROSS T6 (ANODE) AND GROUND (CATHODE).
10. INSERT GREEN LED ACROSS S9 (ANODE) AND GROUND (CATHODE).
11. CONNECT I1 TO GROUND (WHT).
12. CONNECT F10 TO +9V (WHT).
13. CONNECT J1 TO K1 (WHT).
14. CONNECT I4 TO L7 (WHT).
15. CONNECT G4 TO L8 (WHT).
16. CONNECT H9 TO J9 (WHT).
17. CONNECT G10 TO H10 (WHT).
18. CONNECT K10 TO L10 (WHT).
19. CONNECT SPRING 6 TO GROUND (RED).

2. TEST THE CIRCUIT

CHECK FOR ERRORS. BE SURE THAT THE EXPOSED LEADS OF C1, R1 AND R2 DO NOT TOUCH ONE ANOTHER. DISCHARGE ANY STATIC ELECTRICAL CHARGE ON YOUR BODY BY TOUCHING A GROUNDED METAL OBJECT. INSERT THE FOAM PLASTIC PRESSURE SENSOR INTO THE TOUCH SENSOR OPENING. PUSH THE POWER SWITCH ON, AND WAIT FOR THE RED LED TO GLOW. GENTLY TOUCH THE FOAM INSERT IN THE TOUCH SENSOR. THE RED LED SWITCHES OFF, AND THE GREEN LED GLOWS FOR A TIME DETERMINED BY R3 AND C1. THE GREEN LED GLOWS EVEN AFTER YOU REMOVE YOUR FINGER FROM THE TOUCH SENSOR. THIS CIRCUIT WORKS BEST WHEN THE CONDUCTIVE FOAM INSERT IS PLACED INTO THE TOUCH SENSOR. MOISTEN YOUR FINGER TIP AND REMOVE EXCESS MOISTURE WITH A CLOTH OR PAPER TOWEL. REMOVE THE FOAM INSERT FROM THE TOUCH SENSOR. TOUCH YOUR FINGER TIP AGAINST THE TOUCH SENSOR, AND THE RED LED SWITCHES OFF AND THE GREEN LED GLOWS.

USE THE TOUCH SENSOR TO KEEP A TONE ON OR OFF

YOU WILL MODIFY THE CIRCUIT ON PAGE 56 THAT SWITCHES A LED ON OR OFF SO THAT IT SWITCHES A TONE ON OR OFF. THE TONE REMAINS ON FOR A FIXED TIME INTERVAL EVEN AFTER YOU REMOVE YOUR FINGER FROM THE TOUCH SENSOR.

PARTS YOU WILL NEED

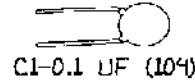
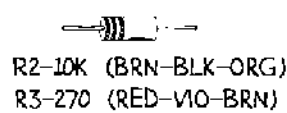
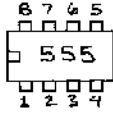

CIRCUIT DIAGRAM

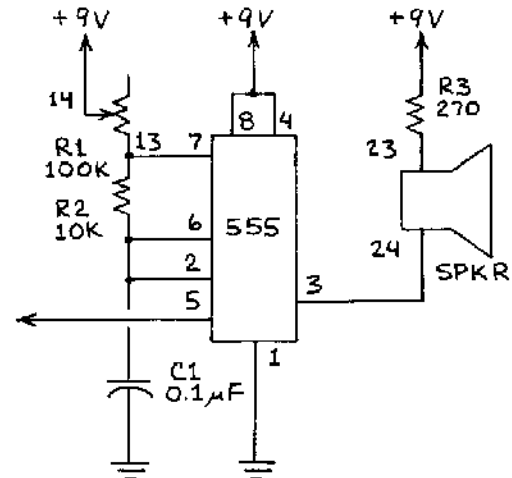

TO PIN 10 OF 4011 FOR NORMALLY ON TONE.
TO PIN 11 OF 4011 FOR NORMALLY OFF TONE.

1. MODIFY THE CIRCUIT THAT KEEPS AN LED ON OR OFF

1. PUSH POWER AND DISPLAY SWITCHES OFF.
2. INSERT 555 IC ACROSS SLOT (PIN 1 AT 05).
3. INSERT R2 ACROSS P10 AND Q10.
4. INSERT R3 ACROSS SPRING 23 AND +9V.
5. INSERT C1 ACROSS O2 AND P2.
6. CONNECT P4 TO Q7 (WHT).
7. CONNECT R4 TO O7 (WHT).
8. CONNECT O1 TO GROUND (WHT).
9. CONNECT O10 TO +9V (RED).
10. CONNECT R10 TO I7 (RED).
11. CONNECT SPRING 13 TO P7 (BLU).
12. CONNECT SPRING 14 TO +9V (BLU).
13. CONNECT SPRING 24 TO Q4 (RED).

2. TEST THE CIRCUIT

THE EXPANDED CIRCUIT IS PRETTY CROWDED, SO CHECK YOUR WIRING CAREFULLY TO MAKE SURE YOU HAVE MADE NO ERRORS. THEN INSERT THE PRESSURE-SENSITIVE BLACK FOAM CYLINDER INTO THE TOUCH SENSOR OPENING. PUSH THE POWER SWITCH ON. YOU WILL HEAR A TONE OR BUZZ. PRESS LIGHTLY ON THE FOAM INSERT IN THE TOUCH SENSOR, AND THE FREQUENCY OF THE TONE CHANGES DRAMATICALLY. TO OPERATE THE CIRCUIT IN A TONE ON-OFF MODE, PUSH THE POWER SWITCH OFF, REMOVE THE RED LED, AND PUSH THE POWER SWITCH ON. IF THE SPEAKER BUZZES, ROTATE 100K CONSOLE POT R1 TOWARD THE LEFT UNTIL THE BUZZ STOPS. TOUCH THE FOAM INSERT IN THE TOUCH SENSOR, AND THE SPEAKER EMITS A TONE FOR A TIME DETERMINED BY R1 AND C1. ADJUST R1 FOR THE BEST SOUND.

3. GOING FURTHER

THE CIRCUIT IS CONNECTED SO THAT THE TONE IS ON. TO CONNECT THE CIRCUIT SO THE TONE IS OFF, REMOVE THE GREEN LED AND MOVE THE RED WIRE AT I7 TO J7. THE TONE IS SWITCHED OFF WHEN YOU TOUCH THE FOAM INSERT IN THE SENSOR SWITCH OPENING.

USE THE TOUCH SENSOR TO SWITCH OFF THE BUZZER

YOU WILL BUILD A SIMPLE TOUCH SWITCH FROM A SINGLE GATE IN A 4011 QUAD NAND GATE AND THE POWER FET. NORMALLY THE BUZZER SOUNDS. TOUCHING THE TOUCH SENSOR QUIETS THE BUZZER. AS WITH THE PREVIOUS CIRCUITS, THIS CIRCUIT INCLUDES TWO 100,000 OHM RESISTORS (R1 AND R2) TO HELP PROTECT THE CMOS GATE FROM ELECTROSTATIC DISCHARGE.

PARTS YOU WILL NEED

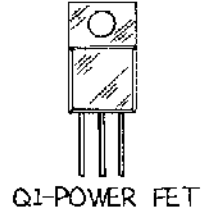
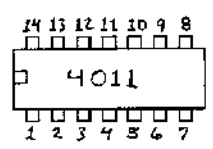

- R1, R2-100K (BRN-BLK-YEL)
- R3 10M (BRN BLK BLU)
- R4-1K (BRN-BLK-RED)

CIRCUIT DIAGRAM

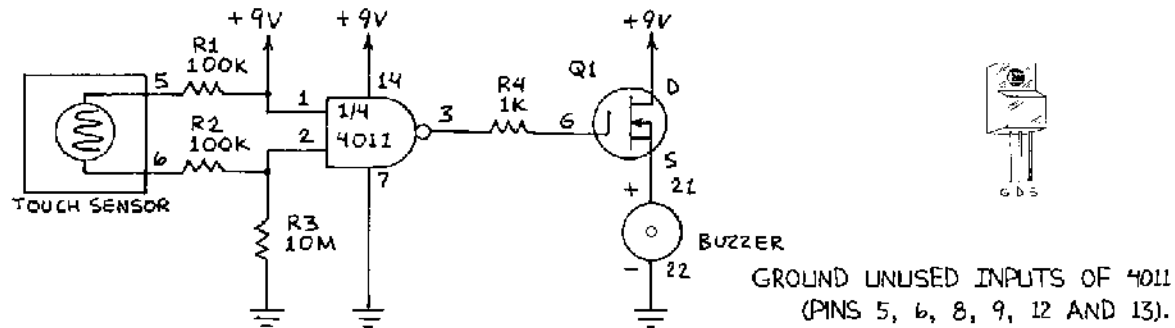

1. BUILD THE CIRCUIT

- | | |
|---|--|
| <ol style="list-style-type: none"> 1. <input type="checkbox"/> PUSH POWER AND DISPLAY SWITCHES OFF. 2. <input type="checkbox"/> INSERT 4011 IC ACROSS SLOT (PIN 1 AT F5). 3. <input type="checkbox"/> INSERT Q1 AT C1 (G), B1 (D) AND A1 (S). 4. <input type="checkbox"/> INSERT R1 ACROSS SPRING 5 AND F1. 5. <input type="checkbox"/> INSERT R2 ACROSS SPRING 6 AND G1. 6. <input type="checkbox"/> INSERT R3 ACROSS G4 AND L4. 7. <input type="checkbox"/> INSERT R4 ACROSS C3 AND H3. 8. <input type="checkbox"/> CONNECT L1 TO GROUND (WHT). 9. <input type="checkbox"/> CONNECT F10 TO +9V (WHT). 10. <input type="checkbox"/> CONNECT F2 TO +9V (WHT). | <ol style="list-style-type: none"> 11. <input type="checkbox"/> CONNECT B5 TO +9V (WHT). 12. <input type="checkbox"/> CONNECT J1 TO K1 (WHT). 13. <input type="checkbox"/> CONNECT K2 TO L2 (WHT). 14. <input type="checkbox"/> CONNECT G10 TO H10 (WHT). 15. <input type="checkbox"/> CONNECT K10 TO L10 (WHT). 16. <input type="checkbox"/> CONNECT H9 TO K9 (WHT). 17. <input type="checkbox"/> CONNECT L7 TO GROUND (WHT). 18. <input type="checkbox"/> CONNECT SPRING 21 TO A5 (RED) 19. <input type="checkbox"/> CONNECT SPRING 22 TO GROUND (BLU). |
|---|--|

2. TEST THE CIRCUIT

INSPECT YOUR WIRING AND FIX ANY ERRORS. BE SURE THAT ALL THE UNUSED 4011 INPUTS ARE CONNECTED TO GROUND. DISCHARGE STATIC ELECTRICITY ON YOUR BODY BY TOUCHING A GROUNDED METAL OBJECT, SUCH AS A SCREW ON A LIGHT SWITCH PLATE. PUSH THE POWER SWITCH ON AND THE BUZZER SOUNDS. PRESS THE TOUCH SENSOR WITH YOUR FINGER AND THE BUZZER IS SILENT. REMOVE YOUR FINGER AND THE BUZZER SOUNDS AGAIN. NOTE THAT THE BUZZER CONTINUES TO SOUND UNTIL YOU PRESS DOWN ON THE TOUCH SENSOR. YOU SHOULDN'T HAVE TO PRESS DOWN VERY HARD UNLESS YOUR SKIN IS UNUSUALLY DRY. VARY THE PRESSURE AND THE ANGLE OF YOUR FINGER FOR BEST RESULTS.

3. GOING FURTHER

AS WITH PREVIOUS TOUCH SENSOR PROJECTS, YOU CAN USE THE PRESSURE SENSOR WITH THIS PROJECT. INSERT THE FOAM PLASTIC PRESSURE SENSOR INTO THE TOUCH SENSOR APERTURE AND PRESS VERY GENTLY. THE BUZZER IS SILENT.

USE THE TOUCH SENSOR TO SWITCH THE BUZZER ON

YOU WILL ADD A GATE TO THE CIRCUIT ON PAGE 58 TO BUILD A TOUCH SWITCH THAT ACTIVATES THE BUZZER. THE BUZZER IS SILENT UNTIL YOU TOUCH THE TOUCH SENSOR. THE CIRCUIT RETAINS THE TWO 100,000 OHM RESISTORS (R1 AND R2) THAT HELP PROTECT THE CMOS GATE FROM ELECTROSTATIC DISCHARGE.

PARTS YOU WILL NEED

THIS CIRCUIT IS A MODIFIED VERSION OF THE ONE ON PAGE 58. NO ADDITIONAL PARTS ARE NECESSARY.

CIRCUIT DIAGRAM

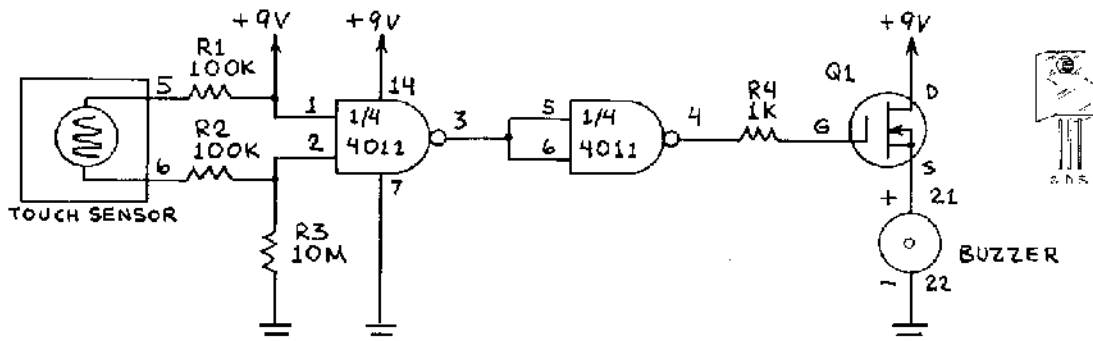

GROUND UNUSED INPUTS OF 4011 (PINS 8, 9, 12, AND 13).

1. MODIFY THE TOUCH SWITCH THAT SWITCHES OFF BUZZER (P. 58)

1. PUSH POWER AND DISPLAY SWITCHES OFF.
2. REMOVE R4 ACROSS C3 AND H3.
3. REMOVE WHT WIRE ACROSS K2 AND L2.
4. INSERT R4 ACROSS C3 AND I3.
5. CONNECT H2 TO J2 (WHT).

2. TEST THE CIRCUIT

BECAUSE YOU HAVE MODIFIED A CIRCUIT THAT YOU PREVIOUSLY BUILT, SOME WIRES OR PARTS MAY HAVE COME LOOSE, SO IT'S IMPORTANT TO CHECK YOUR WIRING CAREFULLY. IF YOU HAVEN'T ALREADY DONE SO, DISCHARGE ANY STATIC ELECTRICAL CHARGE ON YOUR BODY BY TOUCHING A GROUNDED METAL OBJECT, SUCH AS A SCREW ON AN ELECTRICAL LIGHT SWITCH PLATE.

PUSH THE POWER SWITCH ON, AND NOTHING HAPPENS. NOW PRESS YOUR INDEX FINGER AGAINST THE TOUCH SENSOR. THE BUZZER SOUNDS. REMOVE YOUR FINGER, AND THE BUZZER IS SILENT.

3. GOING FURTHER

YOU CAN USE THE PRESSURE SENSOR WITH THIS TOUCH SENSOR PROJECT. INSERT THE FOAM PLASTIC PRESSURE SENSOR INTO THE TOUCH SENSOR APERTURE AND TOUCH OR PRESS DOWN GENTLY ON THE FOAM PLASTIC. THE BUZZER SOUNDS. NOTE THAT THE CIRCUIT IS MUCH MORE SENSITIVE TO TOUCH WHEN THE PRESSURE-SENSITIVE FOAM IS USED.

AS WITH OTHER TOUCH SENSOR PROJECTS, YOU CAN BYPASS THE SENSOR AND USE YOUR FINGER TO BRIDGE SPRINGS 5 AND 6 OR THE LEADS OF RESISTORS R1 AND R2. BE SURE TO TOUCH THE LEADS OF R1 AND R2 THAT MAKE CONTACT WITH SPRINGS 5 AND 6. TOUCHING THE LEADS THAT ARE CONNECTED DIRECTLY TO THE INPUTS OF THE 4011 GATE MAY INTRODUCE STATIC ELECTRICITY THAT CAN DAMAGE THE GATE.

USE A TOUCH SENSOR TO TURN GREEN LED ON/RED LED OFF

YOU WILL USE ALL FOUR GATES IN A 4011 TO BUILD A RED/GREEN LED TOUCH SWITCH. NORMALLY THE RED LED GLOWS. TOUCHING THE TOUCH SENSOR EXTINGUISHES THE RED LED AND CAUSES THE GREEN LED TO GLOW.

PARTS YOU WILL NEED

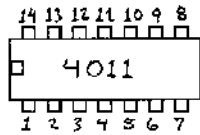

R1, R2-100K (BRN-BLK-YEL)
R3-10M (BRN-BLK-BLU)
R4, R5 470 (YEL VIO BRN)

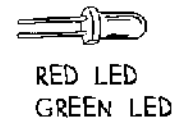

CIRCUIT DIAGRAM

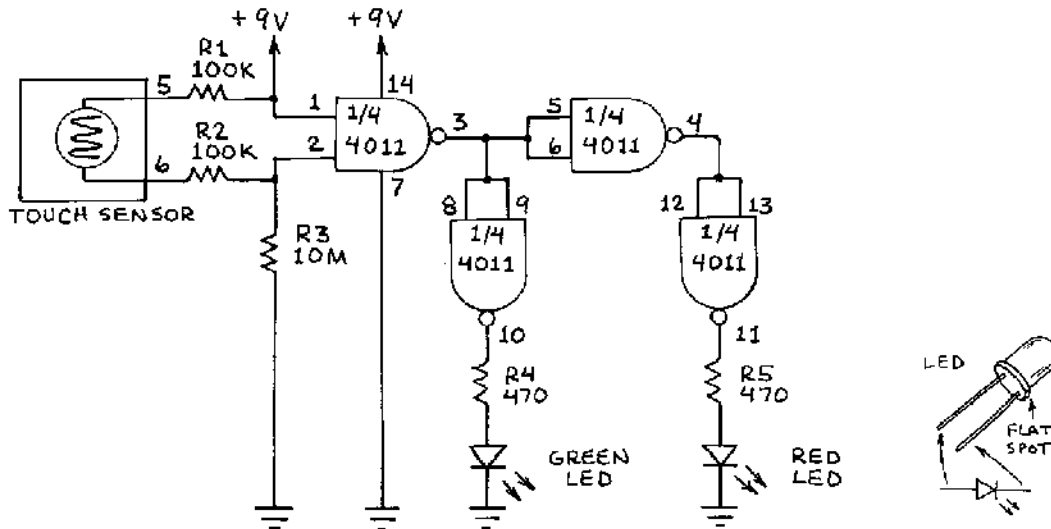

1. BUILD THE CIRCUIT

1. PUSH POWER AND DISPLAY SWITCHES OFF.
2. INSERT 4011 IC ACROSS SLOT (PIN 1 AT F5).
3. INSERT R1 ACROSS SPRING 5 AND F1.
4. INSERT R2 ACROSS SPRING 6 AND G1.
5. INSERT R3 ACROSS G4 AND L4.
6. INSERT R4 ACROSS J10 AND S10.
7. INSERT R5 ACROSS J7 AND T7.
8. INSERT GREEN LED ACROSS S9 (ANODE) AND GROUND (CATHODE).
9. INSERT RED LED ACROSS T6 (ANODE) AND GROUND (CATHODE).
10. CONNECT L1 TO GROUND (WHT).
11. CONNECT F10 TO +9V (WHT).
12. CONNECT F2 TO +9V (WHT).
13. CONNECT H2 TO J2 (WHT).
14. CONNECT J1 TO K1 (WHT).
15. CONNECT I4 TO G7 (WHT).
16. CONNECT H4 TO K7 (WHT).
17. CONNECT G10 TO H10 (WHT).
18. CONNECT K10 TO L10 (WHT).

2. TEST THE CIRCUIT

CHECK YOUR WIRING FOR ERRORS. DISCHARGE ANY STATIC ELECTRICAL CHARGE ON YOUR BODY BY TOUCHING A GROUNDED METAL OBJECT. PUSH THE POWER SWITCH ON, AND THE RED LED GLOWS. PRESS THE TOUCH SENSOR WITH YOUR FINGER. THE RED LED SWITCHES OFF AND THE GREEN LED GLOWS. REMOVE YOUR FINGER AND THE GREEN LED SWITCHES OFF AND THE RED LED AGAIN GLOWS. THIS CIRCUIT IS VERY SENSITIVE AND WORKS FINE WITH FINGER PRESSURE ALONE. IF NOT, INSERT THE FOAM PLASTIC PRESSURE SENSOR INTO THE TOUCH SENSOR APERTURE AND PRESS VERY GENTLY. THE RED LED SWITCHES OFF AND THE GREEN LED GLOWS.

USE A TOUCH SENSOR TO CHANGE THE TONE FREQUENCY

COMBINE TWO GATES IN THE 4011 WITH A 555 CONNECTED AS AN AUDIO OSCILLATOR TO BUILD A TOUCH-CONTROLLED OSCILLATOR. NORMALLY THE SPEAKER EMITS AN ADJUSTABLE TONE. THE TONE BECOMES A BUZZ OR IS SILENCED BY TOUCHING THE TOUCH SENSOR.

PARTS YOU WILL NEED

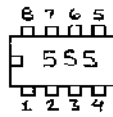
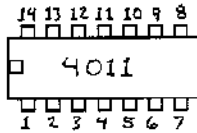

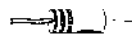
 R1, R2-100K (BRN-BLK-YEL)
R3-10M (BRN-BLK-BLU)
R5-10K (BRN-BLK-ORG)
R6-270 (RED-VIO-BRN)



C1-0.1 UF (104)

CIRCUIT DIAGRAM

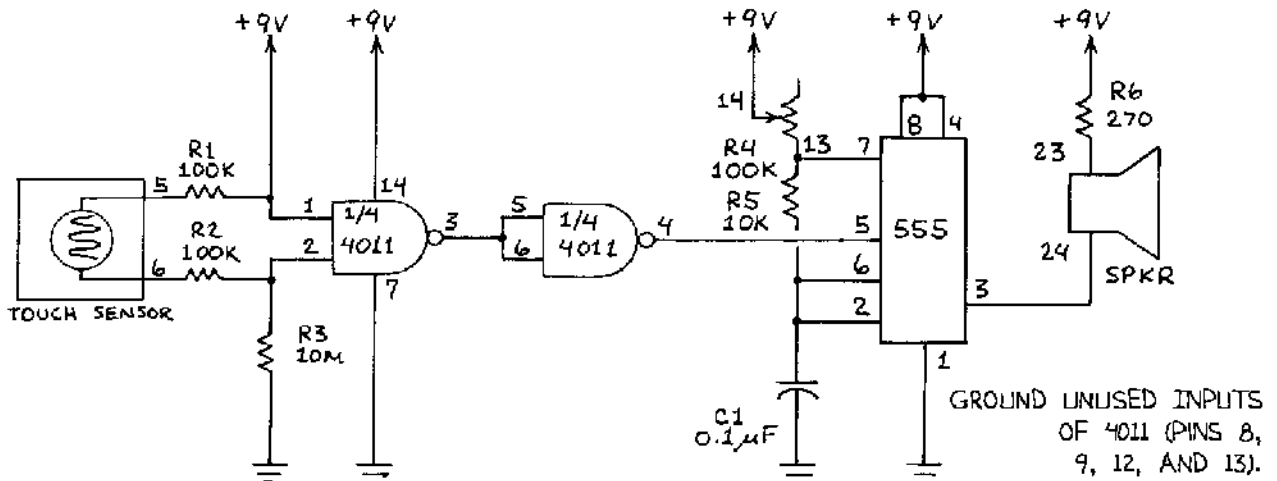

1. BUILD THE CIRCUIT

- | | |
|---|--|
| <ol style="list-style-type: none"> 1. <input type="checkbox"/> PUSH POWER AND DISPLAY SWITCHES OFF. 2. <input type="checkbox"/> INSERT 4011 IC ACROSS SLOT (PIN 1 AT F5). 3. <input type="checkbox"/> INSERT 555 IC ACROSS SLOT (PIN 1 AT Q5). 4. <input type="checkbox"/> INSERT R1 ACROSS SPRING 5 AND F1. 5. <input type="checkbox"/> INSERT R2 ACROSS SPRING 6 AND G1. 6. <input type="checkbox"/> INSERT R3 ACROSS G4 AND L4. 7. <input type="checkbox"/> INSERT R5 ACROSS R10 AND S10. 8. <input type="checkbox"/> INSERT R6 ACROSS C8 AND +9V. 9. <input type="checkbox"/> INSERT C1 ACROSS Q1 AND R1. 10. <input type="checkbox"/> CONNECT L1 TO GROUND (WHT). 11. <input type="checkbox"/> CONNECT F10 TO +9V (WHT). 12. <input type="checkbox"/> CONNECT F2 TO +9V (WHT). 13. <input type="checkbox"/> CONNECT H2 TO J2 (WHT). 14. <input type="checkbox"/> CONNECT J1 TO K1 (WHT). | <ol style="list-style-type: none"> 15. <input type="checkbox"/> CONNECT G10 TO H10 (WHT). 16. <input type="checkbox"/> CONNECT K10 TO L10 (WHT). 17. <input type="checkbox"/> CONNECT H9 TO K9 (WHT). 18. <input type="checkbox"/> CONNECT L9 TO GROUND (WHT). 19. <input type="checkbox"/> CONNECT Q4 TO GROUND (WHT). 20. <input type="checkbox"/> CONNECT R4 TO S7 (WHT). 21. <input type="checkbox"/> CONNECT T4 TO Q7 (WHT). 22. <input type="checkbox"/> CONNECT Q10 TO +9V (RED). 23. <input type="checkbox"/> CONNECT I4 TO T7 (RED). 24. <input type="checkbox"/> CONNECT SPRING 13 TO R7 (BLU). 25. <input type="checkbox"/> CONNECT SPRING 14 TO +9V (BLU). 26. <input type="checkbox"/> CONNECT SPRING 23 TO C10 (RED). 27. <input type="checkbox"/> CONNECT SPRING 24 TO S4 (RED). |
|---|--|

2. TEST THE CIRCUIT

CHECK YOUR WIRING FOR ERRORS. DISCHARGE ANY STATIC ELECTRICITY ON YOUR BODY BY TOUCHING A GROUNDED METAL OBJECT. ROTATE 100K CONSOLE POT R4 TO ITS MIDPOINT. PUSH THE POWER SWITCH ON AND A TONE SOUNDS. ADJUST THE TONE TO YOUR LIKING BY ROTATING R4. TOUCH THE TOUCH SENSOR. THE TONE EITHER CEASES ENTIRELY OR BECOMES A BUZZ. IF THE CIRCUIT DOESN'T RESPOND TO TOUCH, PRESS YOUR FINGER AT A DIFFERENT ANGLE. ADJUST R4 TO SILENCE THE CIRCUIT WHEN YOU TOUCH THE SENSOR.

BUILD A PRESSURE-SENSITIVE RISING TONE OSCILLATOR

THE SENSOR CIRCUITS DESCRIBED IN THE PREVIOUS SECTION (P. 52-61) ARE PRESSURE SENSITIVE TO THE EXTENT THAT THEY CAN BE INFLUENCED BY HOW HARD YOU PRESS THE TOUCH SENSOR. THE CIRCUITS ON PAGES 62-67 ARE SPECIFICALLY DESIGNED TO BE PRESSURE SENSITIVE. THIS IS ACHIEVED BY PLACING A SMALL CYLINDER OF ELECTRICALLY CONDUCTIVE BLACK FOAM PLASTIC OVER THE TOUCH SENSOR ELECTRODES. YOU WILL LEARN HOW TO USE THIS PRESSURE-SENSITIVE FOAM BY BUILDING AN OSCILLATOR THAT EMITS AN AUDIO TONE. THE TONE FREQUENCY RISES WHEN YOU PRESS ON THE PRESSURE SENSOR.

PARTS YOU WILL NEED

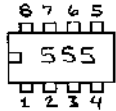

R1-1M (BRN-BLK-GRN)
R2-270 (RED-VIO-BRN)

C1-0.001 uF (102) PRESSURE SENSOR

CIRCUIT DIAGRAM

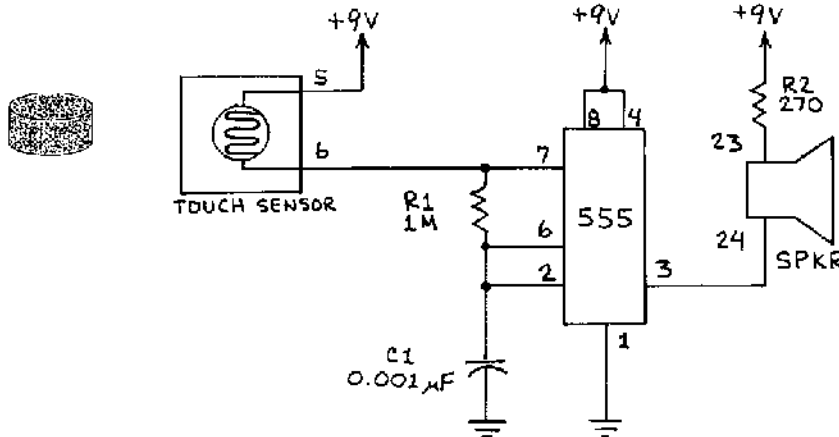

1. BUILD THE CIRCUIT

1. PUSH POWER AND DISPLAY SWITCHES OFF.
2. INSERT 555 IC ACROSS SLOT (PIN 1 AT J5).
3. INSERT R1 ACROSS L10 AND K10.
4. INSERT R2 ACROSS E8 AND J8.
5. INSERT C1 ACROSS J1 AND K1.
6. CONNECT J2 TO GROUND (WHT).
7. CONNECT J10 TO +9V (WHT).
8. CONNECT K4 TO L7 (WHT).
9. CONNECT M4 TO J7 (WHT).
10. CONNECT SPRING 5 TO +9V (RED).
11. CONNECT SPRING 6 TO K7 (RED).
12. CONNECT SPRING 23 TO E10 (RED).
13. CONNECT SPRING 24 TO L4 (RED).

2. TEST THE CIRCUIT

CHECK FOR ERRORS. INSERT THE FOAM CYLINDER INTO THE TOUCH SENSOR OPENING. PUSH THE POWER SWITCH ON. YOU HEAR A BUZZ OR NO SOUND AT ALL. GENTLY PRESS DOWN ON THE PRESSURE SENSOR. A BUZZ THAT QUICKLY BECOMES A TONE SOUNDS AS YOU CONTINUE TO PRESS DOWN ON THE SENSOR. RELAX THE PRESSURE AND THE TONE FREQUENCY FALLS. MOVE YOUR FINGER. THE TONE BECOMES A SLOW BUZZ OR THE SPEAKER BECOMES SILENT.

3. GOING FURTHER

HOLD DIFFERENT OBJECTS ON THE PRESSURE SENSOR WHILE LISTENING TO THE TONE CHANGE. FOR BEST RESULTS, USE OBLONG OBJECTS. CAUTION: AVOID USING HEAVY OBJECTS. USE CARE TO PREVENT THE OBJECT FROM FALLING ON THE CONSOLE. THE CIRCUIT CAN BE MADE INTO A MOVEMENT AND VIBRATION SENSOR. PLACE THE CONSOLE NEAR A WALL AND PLACE A METAL ROD OR SCREWDRIVER SO THE LOWER END RESTS ON THE PRESSURE SENSOR, THE OTHER AGAINST A WALL. MOVEMENTS CAUSE TONE FREQUENCY CHANGES.

BUILD A PRESSURE-SENSITIVE FALLING TONE OSCILLATOR

BUILD AN AUDIO OSCILLATOR THAT CREATES A TONE FREQUENCY THAT FALLS WITH PRESSURE. THIS CONTRASTS WITH THE PREVIOUS CIRCUIT, WHERE THE FREQUENCY RISES WITH PRESSURE.

PARTS YOU WILL NEED

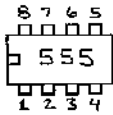

R3-10K (BRN-BLK-ORG)
R4-270 (RED-VIO-BRN)

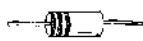

C1-0.1 UF (104)



PRESSURE SENSOR

CIRCUIT DIAGRAM

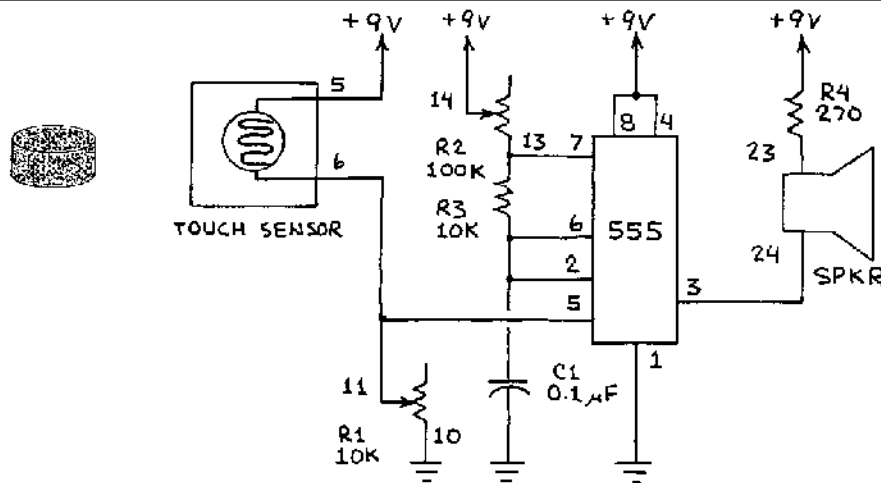

1. BUILD THE CIRCUIT

1. PUSH POWER AND DISPLAY SWITCHES OFF.
2. INSERT 555 IC ACROSS SLOT (PIN 1 AT J5).
3. INSERT R3 ACROSS L10 AND K10.
4. INSERT R4 ACROSS E8 AND J8.
5. INSERT C1 ACROSS J1 AND K1.
6. CONNECT J2 TO GROUND (WHT).
7. CONNECT J10 TO +9V (WHT).
8. CONNECT K4 TO L7 (WHT).
9. CONNECT M4 TO J7 (WHT).
10. CONNECT SPRING 5 TO +9V (RED).
11. CONNECT SPRING 6 TO M8 (RED).
12. CONNECT SPRING 10 TO GROUND (RED).
13. CONNECT SPRING 11 TO M9 (RED).
14. CONNECT SPRING 13 TO K9 (BLU).
15. CONNECT SPRING 14 TO +9V (BLU).
16. CONNECT SPRING 23 TO E10 (RED).
17. CONNECT SPRING 24 TO L4 (RED).

2. TEST THE CIRCUIT

CHECK WIRING FOR ERRORS. INSERT THE BLACK FOAM CYLINDER INTO THE TOUCH SENSOR OPENING. ROTATE 10K CONSOLE POT R1 TO ITS MID-POINT. PUSH THE POWER SWITCH ON. AN AUDIO TONE SOUNDS. ADJUST 100K CONSOLE POT R2 UNTIL THE TONE FREQUENCY IS REASONABLY PLEASANT. NOW PRESS DOWN ON THE PRESSURE SENSOR WITH YOUR FINGER. THE FREQUENCY OF THE TONE FALLS. YOU CAN ADJUST BOTH R1 AND R2 TO ALTER THE CIRCUIT TONE RANGE. R1 AND THE PRESSURE SENSOR FORM A VOLTAGE DIVIDER, SO PRESSING DOWN ON THE PRESSURE SENSOR OR ADJUSTING R1 CHANGES THE VOLTAGE AT THE CONTROL INPUT (PIN 5) OF THE 555. THIS CHANGES THE TONE FREQUENCY. R2 IS INDEPENDENT OF THE PRESSURE SENSOR. CHANGING ITS VALUE CHANGES THE TONE FREQUENCY.

3. GOING FURTHER

THE EXPERIMENTS DESCRIBED IN GOING FURTHER ON PAGE 62 CAN ALSO BE TRIED WITH THIS CIRCUIT. CAUTION: AVOID USING HEAVY OBJECTS AND USE CARE TO PREVENT THE OBJECT FROM FALLING ON THE CONSOLE.

BUILD A PRESSURE-ACTIVATED TONE GENERATOR

BUILD A CIRCUIT THAT PRODUCES A TONE ONLY WHEN THE PRESSURE SENSOR IS PRESSED. IT CAN BE EASILY MODIFIED TO PRODUCE A TONE THAT IS SWITCHED OFF BY PRESSURE.

PARTS YOU WILL NEED

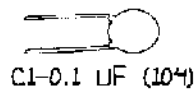
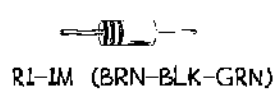
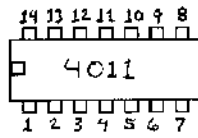
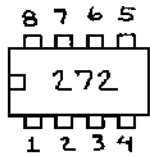

CIRCUIT DIAGRAM

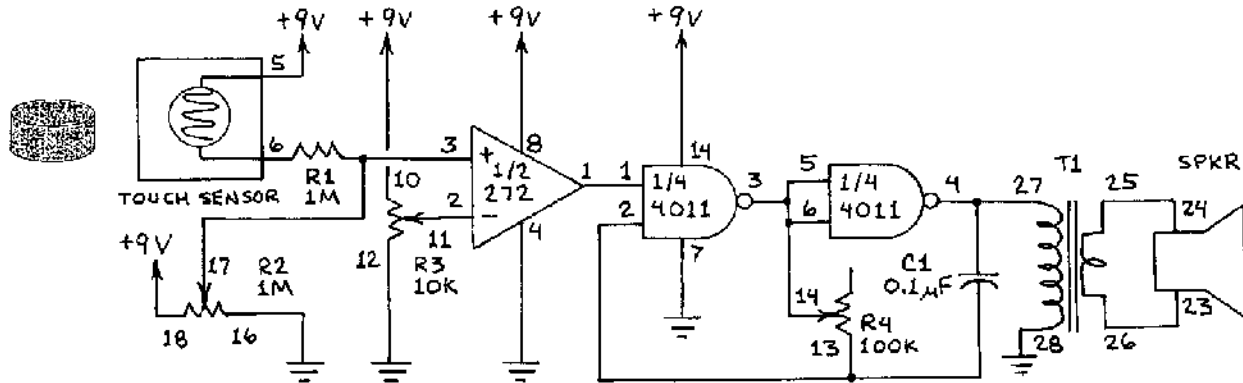

GROUND UNUSED INPUTS OF 4011 (PINS 8, 9, 12 AND 13).

1. BUILD THE CIRCUIT

1. PUSH POWER AND DISPLAY SWITCHES TO OFF.
2. INSERT 272 IC ACROSS SLOT (PIN 1 AT E5).
3. INSERT 4011 IC ACROSS SLOT (PIN 1 AT N5).
4. INSERT R1 ACROSS SPRING 6 AND G1.
5. INSERT C1 ACROSS O1 AND Q1.
6. CONNECT H1 TO GROUND (WHT).
7. CONNECT E10 TO +9V (WHT).
8. CONNECT T4 TO GROUND (WHT).
9. CONNECT N9 TO +9V (RED).
10. CONNECT E4 TO N4 (WHT).
11. CONNECT P3 TO R3 (WHT).
12. CONNECT R2 TO S2 (WHT).
13. CONNECT O10 TO P10 (WHT).
14. CONNECT P9 TO S9 (WHT).
15. CONNECT S10 TO T10 (WHT).
16. CONNECT T9 TO GROUND (WHT).
17. CONNECT SPRING 5 TO +9V (RED).
18. CONNECT SPRING 10 TO +9V (BLU).
19. CONNECT SPRING 11 TO F1 (RED).
20. CONNECT SPRING 12 TO GROUND (RED).
21. CONNECT SPRING 13 TO O2 (RED).
22. CONNECT SPRING 14 TO P2 (BLU).
23. CONNECT SPRING 16 TO GROUND (BLU).
24. CONNECT SPRING 17 TO G3 (BLU).
25. CONNECT SPRING 18 TO +9V (BLU).
26. CONNECT SPRINGS 23 AND 26 (RED).
27. CONNECT SPRINGS 24 AND 25 (WHT).
28. CONNECT SPRING 27 TO Q4 (RED).
29. CONNECT SPRING 28 TO GROUND (RED).

2. TEST THE CIRCUIT

CHECK FOR ERRORS. ADJUST 100K CONSOLE POT R4 2/3 TO THE RIGHT. ADJUST 10K AND 1M CONSOLE POTS R3 AND R2 TO THEIR MID-POINTS. INSERT THE PRESSURE-SENSITIVE FOAM CYLINDER INTO THE TOUCH SENSOR OPENING. NOW PUSH THE POWER SWITCH ON. IF YOU HEAR A TONE, ADJUST R2 OR R3 TO THE RIGHT UNTIL THE TONE STOPS. PRESS GENTLY ON THE PRESSURE SENSOR. YOU SHOULD HEAR A TONE. REVERSE THE CIRCUIT OPERATION BY REMOVING THE RED WIRE BETWEEN SPRING 5 AND +9V. CONNECT A RED WIRE FROM SPRING 5 TO GROUND. ADJUST R2 AND R3 UNTIL THE TONE STOPS WHEN THE SENSOR IS PRESSED.

USE PRESSURE TO SPEED UP A FLASHING LED

MANY CIRCUITS CAN CHANGE THE RATE AT WHICH A LED FLASHES. MOST ARE CONTROLLED BY ADJUSTING A POTENTIOMETER. THE CIRCUIT YOU ARE ABOUT TO BUILD IS UNIQUE BECAUSE YOU CONTROL THE LED FLASH RATE BY SIMPLY PRESSING DOWN ON THE PRESSURE SENSOR. YOU WILL BUILD THE CIRCUIT AND ADJUST A CONTROL POTENTIOMETER TO GIVE VARIOUS EFFECTS.

PARTS YOU WILL NEED

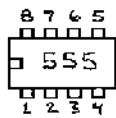

R2 10K (BRN BLK ORG)
R3-470 (YEL-VIO-BRN)



C1 1 μ F

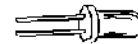

RED LED



PRESSURE SENSOR

CIRCUIT DIAGRAM

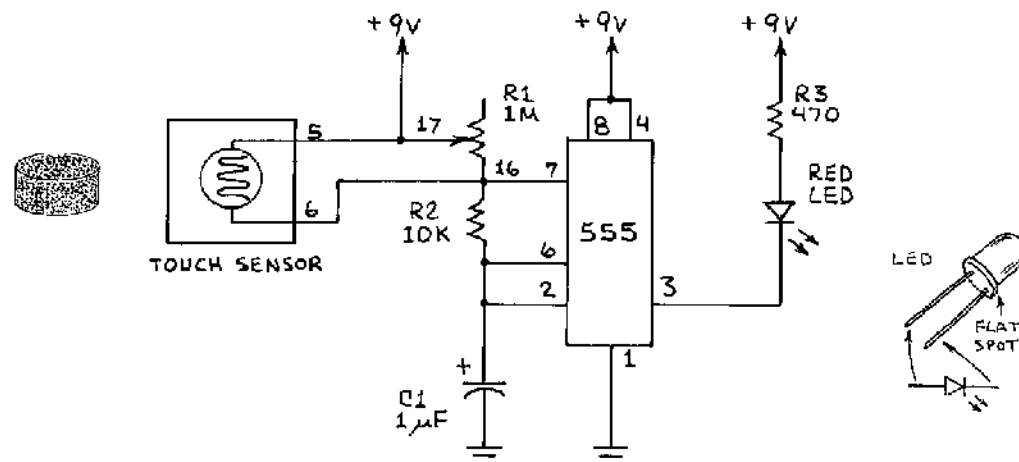

1. BUILD THE CIRCUIT

1. PUSH POWER AND DISPLAY SWITCHES OFF.
2. INSERT 555 IC ACROSS SLOT (PIN 1 AT J5).
3. INSERT R2 ACROSS L10 AND K10.
4. INSERT R3 ACROSS I5 AND +9V.
5. INSERT C1 ACROSS K1 (+) AND J1 (-).
6. CONNECT J2 TO GROUND (WHT).
7. INSERT RED LED ACROSS I4 (ANODE) AND L4 (CATHODE).
8. CONNECT J10 TO +9V (WHT).
9. CONNECT K4 TO I7 (WHT).
10. CONNECT M4 TO J7 (WHT).
11. CONNECT SPRING 5 TO +9V (RED).
12. CONNECT SPRING 6 TO K8 (RED).
13. CONNECT SPRING 16 TO K9 (BLU).
14. CONNECT SPRING 17 TO +9V (BLU).

2. TEST THE CIRCUIT

CHECK YOUR WIRING FOR ERRORS. INSERT THE PRESSURE-SENSITIVE BLACK FOAM CYLINDER INTO THE TOUCH SENSOR OPENING. ROTATE 1M CONSOLE POT R1 TO ITS MID-POINT, THEN PUSH THE POWER SWITCH UP. THE LED FLASHES A FEW TIMES PER SECOND. PRESS DOWN ON THE PRESSURE SENSOR. THE LED FLASH RATE SPEEDS UP DRAMATICALLY. WHEN THE FLASH RATE REACHES AROUND 16 FLASHES PER SECOND, THE LED APPEARS TO GLOW CONTINUOUSLY. ADJUST R1 TO ALTER THE OVERALL FLASH RANGE. FOR EXAMPLE, WHILE PRESSING DOWN ON THE PRESSURE SENSOR, ADJUST R1 UNTIL YOU ACHIEVE A DESIRED FLASH RATE, THEN RELEASE THE PRESSURE TO SEE WHAT HAPPENS.

3. GOING FURTHER

FOR A SLOWER FLASH RATE, REPLACE C1 WITH A 4.7 μ F CAPACITOR. YOU CAN ALSO REPLACE THE RED LED WITH A GREEN LED. IN BOTH CASES, BE SURE TO OBSERVE POLARITY.

USE PRESSURE TO SLOW A FLASHING LED

SLOWING DOWN A FLASHING LED IS A BIT MORE COMPLICATED THAN SPEEDING UP THE FLASH RATE. YOU WILL USE THE CONTROL INPUT OF A 555 IC TO SLOW DOWN A FLASHING LED BY CONNECTING THE PRESSURE SENSOR AND A POTENTIOMETER IN SERIES TO FORM A VOLTAGE DIVIDER. PRESSING DOWN ON THE PRESSURE SENSOR CHANGES ITS RESISTANCE. THIS ALTERS THE VOLTAGE THAT THE DIVIDER APPLIES TO THE CONTROL INPUT OF THE 555.

PARTS YOU WILL NEED

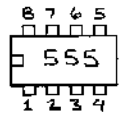

R3 10K (BRN BLK ORG)
R4 470 (YEL-VIO-BRN)

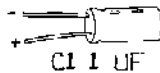

C1 1 µF



RED LED



PRESSURE SENSOR

CIRCUIT DIAGRAM

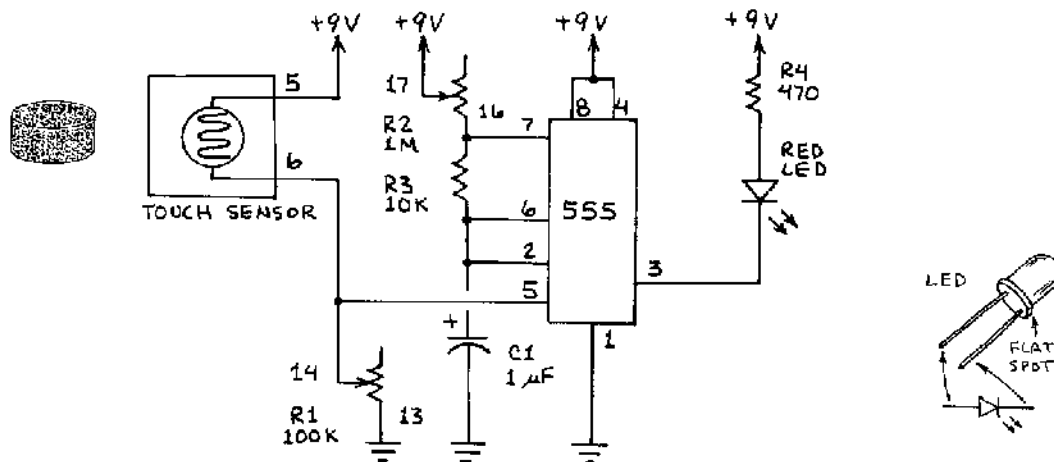

1. BUILD THE CIRCUIT

1. PUSH POWER AND DISPLAY SWITCHES OFF.
2. INSERT 555 IC ACROSS SLOT (PIN 1 AT J5).
3. INSERT R3 ACROSS K10 AND L10.
4. INSERT R4 ACROSS H1 AND +9V.
5. INSERT C1 ACROSS K1 (+) AND J1 (-).
6. INSERT LED ACROSS H3 (ANODE) AND L3 (CATHODE).
7. CONNECT J2 AND GROUND (WHT).
8. CONNECT J10 TO +9V (WHT).
9. CONNECT M4 AND J7 (WHT).
10. CONNECT K4 AND L7 (WHT).
11. CONNECT SPRING 5 TO +9V (RED).
12. CONNECT SPRING 6 TO M7 (RED).
13. CONNECT SPRING 13 TO GROUND (RED).
14. CONNECT SPRINGS 14 AND 6 (BLU).
15. CONNECT SPRING 16 TO K9 (BLU).
16. CONNECT SPRING 17 TO J9 (BLU).

2. TEST THE CIRCUIT

CHECK FOR ERRORS. THE 100K CONSOLE POTENTIOMETER R1 AND THE PRESSURE SENSOR CONTROL CHANGES IN THE LED FLASH RATE. ROTATE R1 ALL THE WAY TO THE LEFT. THE 1M CONSOLE POTENTIOMETER R2 CONTROLS THE BASIC FLASH RATE OF THE LED. ADJUST R2 TO ITS MID-POINT. INSERT THE PRESSURE-SENSITIVE BLACK FOAM CYLINDER INTO THE TOUCH SENSOR OPENING, THEN PUSH THE POWER SWITCH ON. THE LED FLASHES. PRESS DOWN ON THE FOAM PLASTIC PRESSURE SENSOR, AND THE FLASH RATE OF THE LED SLOWS. YOU CAN BETTER SEE THE CHANGE BY ROTATING R2 UNTIL THE FLASHES FROM THE LED MERGE TOGETHER. NOW WHEN YOU PRESS DOWN ON THE PRESSURE SENSOR, THE SLOWER FLASH RATE IS MORE APPARENT.

BUILD A SIMPLE SCALE WITH A BARGRAPH READOUT

CONNECT THE PRESSURE SENSOR TO THE LED BARGRAPH READOUT TO FORM AN ELECTRONIC SCALE. A 272 OPERATIONAL AMPLIFIER MULTIPLIES THE PRESSURE TEN TIMES TO INCREASE THE SENSITIVITY OF THE SCALE. A GREEN LED GLOWS TO INDICATE THE READOUT IS OFF-SCALE.

PARTS YOU WILL NEED

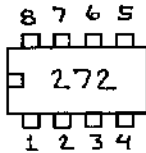

R2-1M (BRN-BLK-GRN)
 R3-10K (BRN-BLK-ORG)
 R4-100K (BRN-BLK-YEL)
 R5-150 (BRN-GRN-BRN)

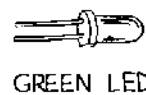

GREEN LED



PRESSURE SENSOR

CIRCUIT DIAGRAM

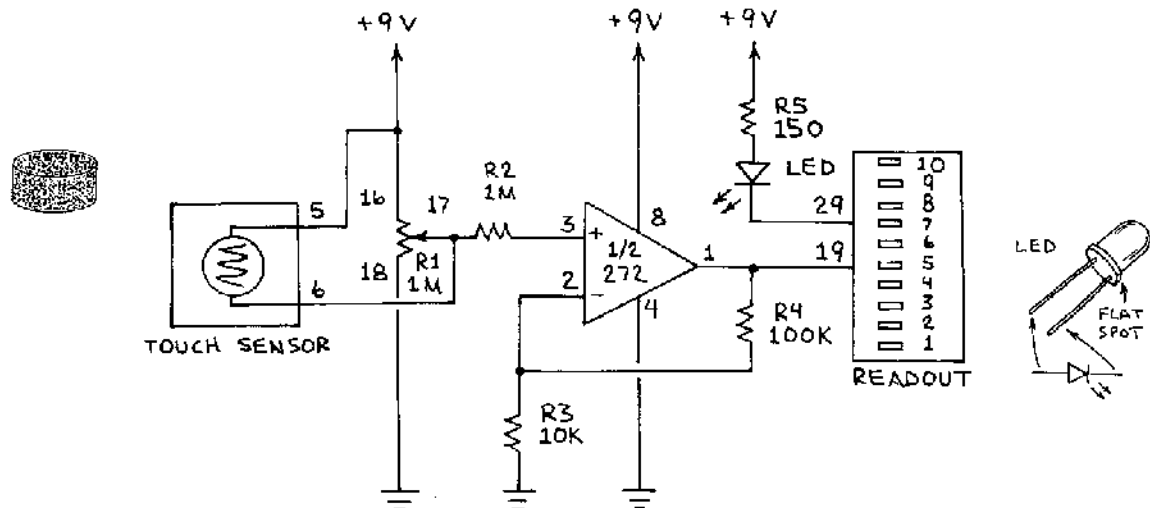

1. BUILD THE CIRCUIT

1. PUSH POWER AND DISPLAY SWITCHES OFF.
2. INSERT 272 IC ACROSS SLOT (PIN 1 AT J5).
3. INSERT R2 ACROSS G3 AND L3.
4. INSERT R3 ACROSS K2 AND GROUND.
5. INSERT R4 ACROSS J1 AND K1.
6. INSERT R5 ACROSS A8 AND +9V.
7. INSERT LED ACROSS A6 (ANODE) AND D6 (CATHODE).
8. CONNECT M1 TO GROUND (WHT).
9. CONNECT J10 TO +9V (WHT).
10. CONNECT SPRING 5 AND +9V (RED).
11. CONNECT SPRING 6 TO G1 (RED).
12. CONNECT SPRING 19 TO J4 (RED).
13. CONNECT SPRING 16 TO +9V (BLU).
14. CONNECT SPRING 17 TO G4 (BLU).
15. CONNECT SPRING 18 TO GROUND (BLU).
16. CONNECT SPRING 29 TO D10 (BLU).

2. TEST THE CIRCUIT

CHECK FOR ERRORS. INSERT THE BLACK FOAM CYLINDER INTO THE TOUCH SENSOR OPENING. ROTATE 1M CONSOLE POT R1 ALL THE WAY TO THE LEFT. PUSH THE POWER SWITCH UP AND PUSH THE DISPLAY MODE SWITCH TO DOT. ROTATE R1 TO THE RIGHT UNTIL ONLY READOUT LED 1 GLOWS. GENTLY PRESS DOWN ON THE PRESSURE SENSOR. A GLOWING LED MOVES UP THE READOUT AS THE PRESSURE INCREASES. WHEN THE PRESSURE CAUSES THE READOUT TO GO OFF SCALE, THE GREEN LED GLOWS. RELAX THE PRESSURE ON THE SENSOR AND A GLOWING LED MOVES BACK DOWN THE READOUT.

3. GOING FURTHER

INCREASE THE SCALE SENSITIVITY BY REPLACING R3 WITH A 1K RESISTOR. REMOVE R3 AND INSERT THE 1K RESISTOR ACROSS K2 AND GROUND. THE CIRCUIT IS NOW SO SENSITIVE THAT EVEN VERY GENTLE PRESSURE SENDS THE READOUT OFF SCALE.

USE THE PROBE SENSOR TO DETECT RESISTANCE

THE PROBE SENSOR CARD CAN BE CONNECTED DIRECTLY TO THE LED READOUT TO PROVIDE A SIMPLE RESISTANCE SENSOR. YOU WILL BUILD THIS CIRCUIT AND USE IT TO SENSE RESISTANCE OF YOUR SKIN AND WATER. YOU WILL ALSO BUILD A SIMPLE TIMER FROM A SINGLE CAPACITOR.

PARTS YOU WILL NEED

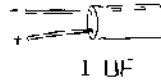
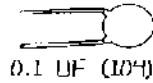
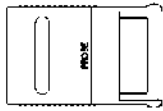

CIRCUIT DIAGRAM

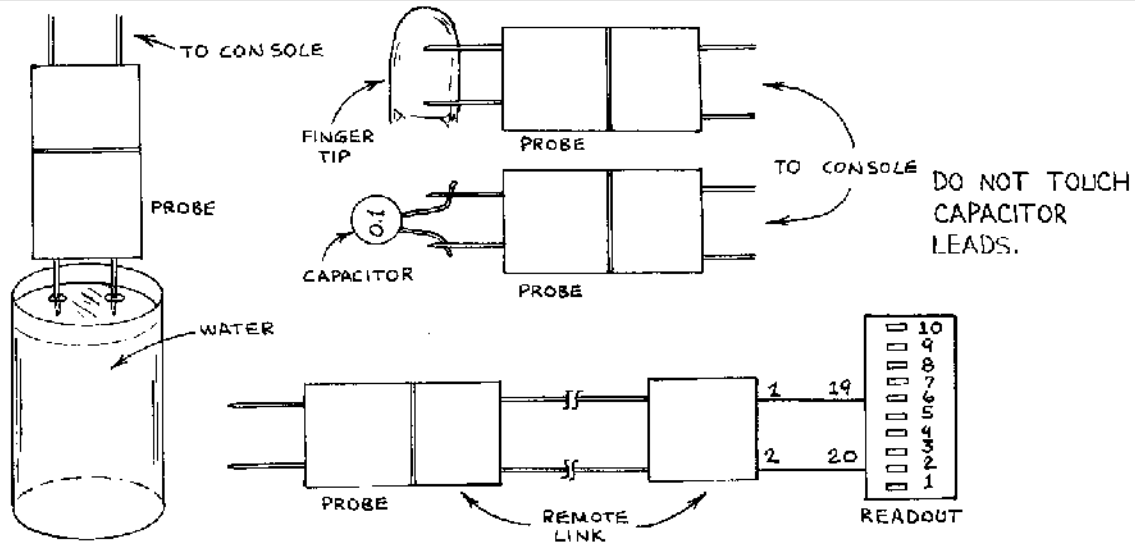

1. BUILD THE CIRCUIT

1. PUSH POWER AND DISPLAY SWITCHES OFF.
2. INSERT PROBE CARD IN REMOTE LINK SOCKET.
3. INSERT REMOTE LINK INTO SENSOR SOCKET.
4. CONNECT SPRINGS 1 AND 19 (BLU).
5. CONNECT SPRINGS 2 AND 20 (BLU).

2. TEST THE CIRCUIT

REMOVE ELECTRICAL CHARGE FROM YOUR BODY. PLACE PROBE SENSOR CARD SO EXPOSED PROBES DO NOT TOUCH ANYTHING. PUSH THE POWER SWITCH ON AND THE DISPLAY MODE SWITCH TO DOT. READOUT LED 10 GLOWS, INDICATING RESISTANCE BETWEEN EXPOSED PROBES.

SKIN RESISTANCE: GENTLY PRESS THE PROBES AGAINST A FINGER TIP. THE GLOWING LED MOVES DOWNWARD. PRESS SLIGHTLY HARDER AND EVENTUALLY LED 1 GLOWS. MOISTEN YOUR FINGER TIP AND REPEAT. LESS PRESSURE IS NEEDED TO MOVE THE GLOWING LED FROM 10 TO 1, BECAUSE MOISTURE GREATLY REDUCES THE RESISTANCE BETWEEN THE PROBES.

WATER RESISTANCE: INSERT PROBES A SHORT DISTANCE INTO WATER. THE POSITION OF THE GLOWING LED INDICATES IF THE WATER RESISTANCE IS LOW OR HIGH.

CAPACITOR TIMER: TOUCH THE LEADS OF A 0.1 uF CAPACITOR (10⁴) TOGETHER TO REMOVE CHARGE. SPREAD LEADS APART AND TOUCH THE PROBES TO THE TWO LEADS. READOUT LED 1 GLOWS. AFTER HALF A SECOND OR SO, LED 2 GLOWS. THIS CONTINUES UNTIL LED 10 GLOWS. TO SLOW THE MOVING DOT, PLACE A 1 uF ELECTROLYTIC CAPACITOR ACROSS THE PROBES. SHORT THE CAPACITOR LEADS TOGETHER, THEN THE PROBE NEAREST THE BLACK REMOTE LINK WIRE SHOULD TOUCH THE LEAD OF THE CAPACITOR MARKED WITH A (-) SIGN. AFTER 5 SECONDS OR SO, LED 1 GLOWS. THIS CYCLE CONTINUES UNTIL LED 10 GLOWS.

BUILD A HIGH-SENSITIVITY SKIN RESISTANCE MONITOR

YOU CAN DETECT SKIN RESISTANCE WITH A LED READOUT AND NO OTHER COMPONENTS. USE AN OPERATIONAL AMPLIFIER TO SENSE SKIN RESISTANCE WITH GREATER SENSITIVITY.

PARTS YOU WILL NEED

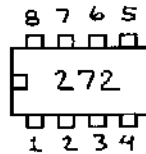
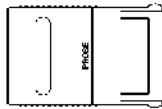

R1-10K (BRN-BLK-ORG)
R3-1K (BRN-BLK-RED)

CIRCUIT DIAGRAM

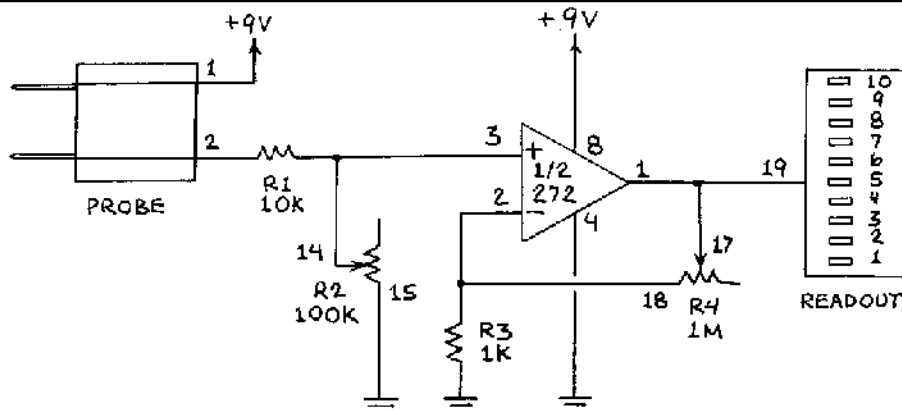

1. BUILD THE CIRCUIT

1. PUSH POWER AND DISPLAY SWITCHES OFF.
2. INSERT PROBE CARD IN SENSOR SOCKET.
3. INSERT 272 ACROSS SLOT (PIN 1 AT J5).
4. INSERT R1 ACROSS A4 AND L4.
5. INSERT R3 ACROSS K2 AND GROUND.
6. CONNECT M1 TO GROUND (WHT).
7. CONNECT J10 TO +9V (WHT).
8. CONNECT SPRING 1 TO +9V (WHT).
9. CONNECT SPRING 2 TO A5 (RED).
10. CONNECT SPRING 14 TO L1 (BLU).
11. CONNECT SPRING 15 TO GROUND (RED).
12. CONNECT SPRING 18 TO K4 (BLU).
13. CONNECT SPRING 17 TO J4 (BLU).
14. CONNECT SPRING 19 TO J1 (RED).

2. TEST THE CIRCUIT

REMOVE ELECTRICAL CHARGE ON YOUR BODY BY TOUCHING A GROUNDED OBJECT. INSPECT YOUR WIRING AND CORRECT ANY MISTAKES. ROTATE 1M CONSOLE POTENTIOMETER R4 ALL THE WAY TO THE LEFT. PUSH THE POWER SWITCH ON AND THE DISPLAY SWITCH TO DOT. MOISTEN YOUR FINGER TIPS AND PLACE THEM ACROSS THE PROBES OF THE PROBE SENSOR. ROTATE THE 100K CONSOLE POT R2 BACK AND FORTH. A GLOWING LED MOVES UP AND DOWN THE READOUT. TO INCREASE SENSITIVITY, SET R2 SO THAT ONE OF THE LEDS NEAR THE BOTTOM OF THE READOUT GLOWS WHEN YOUR FINGER TIPS ARE ACROSS THE PROBES. SLOWLY ROTATE R4 TO THE RIGHT. THIS INCREASES THE OPERATIONAL AMPLIFIER'S GAIN, WHICH GREATLY INCREASES THE CIRCUIT'S SENSITIVITY TO RESISTANCE. WHEN A RESISTANCE SENSOR IS MADE FROM THE LED ALONE (SEE PAGE 68), A LOW RESISTANCE ACROSS THE PROBES MOVES THE GLOWING LED DOWN. IN THIS CIRCUIT, A LOW RESISTANCE MOVES THE GLOWING LED UP.

3. GOING FURTHER

YOU CAN USE THE REMOTE LINK TO MOVE THE PROBE AND DO VARIOUS EXPERIMENTS. FOR EXAMPLE, YOU CAN INSERT THE PROBE TIPS INTO SOIL AND MONITOR ITS RESISTANCE. MOIST SOIL HAS LOWER RESISTANCE THAN DRY SOIL. YOU CAN ADJUST R2 AND R4 SO THAT LED 10 GLOWS WHEN THE SOIL IS MOIST. AS THE SOIL DRIES, THE GLOWING LED MOVES DOWN.

BUILD A MOISTURE AND WATER DETECTION BUZZER

CIRCUITS THAT DETECT MOIST SURFACES AND WATER HAVE MANY USES. THEY ARE USED TO SOUND AN ALARM WHEN BASEMENTS FLOOD, WHEN BOATS TAKE ON WATER, AND TO ADVISE BLIND PEOPLE WHEN TO STOP POURING LIQUID INTO A CUP OR COOKING POT. YOU WILL BUILD A WATER DETECTION CIRCUIT THAT SOUNDS THE CONSOLE BUZZER WHEN THE PROBE ELECTRODES TOUCH MOIST SKIN OR ARE IMMERSED IN WATER.

PARTS YOU WILL NEED

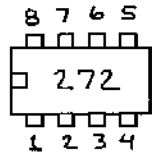
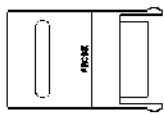

R1-1M (BRN-BLK-GRN)
 R3, R5-1K (BRN-BLK-RED)
 R4-10M (BRN-BLK-BLU)



CIRCUIT DIAGRAM

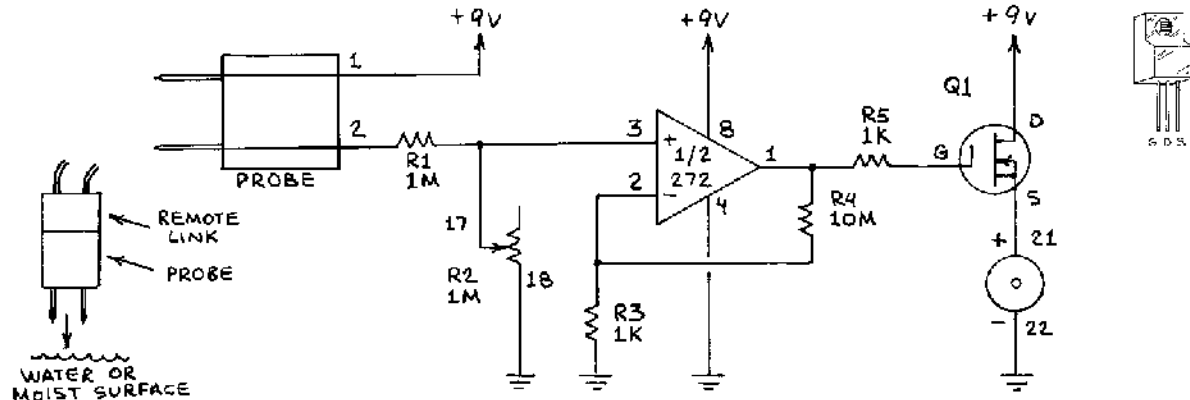

1. BUILD THE CIRCUIT

- | | |
|--|--|
| <ol style="list-style-type: none"> 1. <input type="checkbox"/> PUSH POWER AND DISPLAY SWITCHES OFF. 2. <input type="checkbox"/> INSERT PROBE CARD IN SENSOR SOCKET. 3. <input type="checkbox"/> INSERT 272 IC ACROSS SLOT (PIN 1 AT J5). 4. <input type="checkbox"/> INSERT Q1 AT A1 (S), B1 (D) AND C1 (G). 5. <input type="checkbox"/> INSERT R1 ACROSS L4 AND E6. 6. <input type="checkbox"/> INSERT R3 ACROSS K2 AND GROUND. 7. <input type="checkbox"/> INSERT R4 ACROSS J1 AND K1. 8. <input type="checkbox"/> INSERT R5 ACROSS C4 AND J4. | <ol style="list-style-type: none"> 9. <input type="checkbox"/> CONNECT M1 TO GROUND (WHT). 10. <input type="checkbox"/> CONNECT J10 TO +9V (WHT). 11. <input type="checkbox"/> CONNECT B5 TO +9V (WHT). 12. <input type="checkbox"/> CONNECT SPRING 1 TO +9V (WHT). 13. <input type="checkbox"/> CONNECT SPRING 2 TO E10 (RED). 14. <input type="checkbox"/> CONNECT SPRING 17 TO L3 (BLU). 15. <input type="checkbox"/> CONNECT SPRING 18 TO GROUND (BLU). 16. <input type="checkbox"/> CONNECT SPRING 21 TO A5 (RED). 17. <input type="checkbox"/> CONNECT SPRING 22 TO GROUND (BLU). |
|--|--|

2. TEST THE CIRCUIT

REMOVE ELECTRICAL CHARGE FROM YOUR BODY BY TOUCHING A GROUNDED OBJECT. CHECK YOUR WIRING FOR ERRORS. PUSH THE POWER SWITCH ON. MOISTEN YOUR FINGERTIPS AND PLACE THEM ACROSS THE EXPOSED PROBES. ADJUST 1M CONSOLE POT R2 UNTIL THE BUZZER JUST SOUNDS. REMOVE YOUR FINGERS AND THE BUZZER IS SILENT. CONNECT THE PROBE CARD TO THE REMOTE LINK. DIP THE PROBES SLIGHTLY INTO THE WATER, AND THE BUZZER SOUNDS. REMOVE THE PROBES AND THE BUZZER IS SILENT. ADJUST R2 FOR BEST RESULTS. PLACE ONLY THE ENDS OF THE PROBES IN THE WATER.

3. GOING FURTHER

REDUCE THE CIRCUIT SENSITIVITY BY REPLACING R4 WITH A 1M RESISTOR (BRN-BLK-GRN). WHAT HAPPENS TO THE CIRCUIT'S SENSITIVITY WHEN YOU ADD A DROP OF LEMON JUICE OR VINEGAR TO THE WATER? BOTH LIQUIDS ARE ACIDS, MEANING THEY GREATLY REDUCE THE WATER'S RESISTANCE.

BUILD A DIGITAL LOGIC WATER DETECTION CIRCUIT

MOST PROBE CIRCUITS IN THIS MANUAL HAVE AN ANALOG INPUT (272 OPERATIONAL AMPLIFIER OR 555 TIMER). THIS CIRCUIT HAS A DIGITAL INPUT (4011 QUAD NAND GATE). BY BUILDING THIS CIRCUIT, YOU WILL LEARN HOW FLEXIBLE THE DESIGN OF PROBE CIRCUITS CAN BE.

PARTS YOU WILL NEED

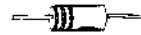
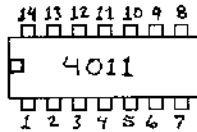
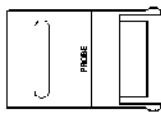

R1-1K (BRN-BLK-RED)



C1-0.1 UF (104)

CIRCUIT DIAGRAM

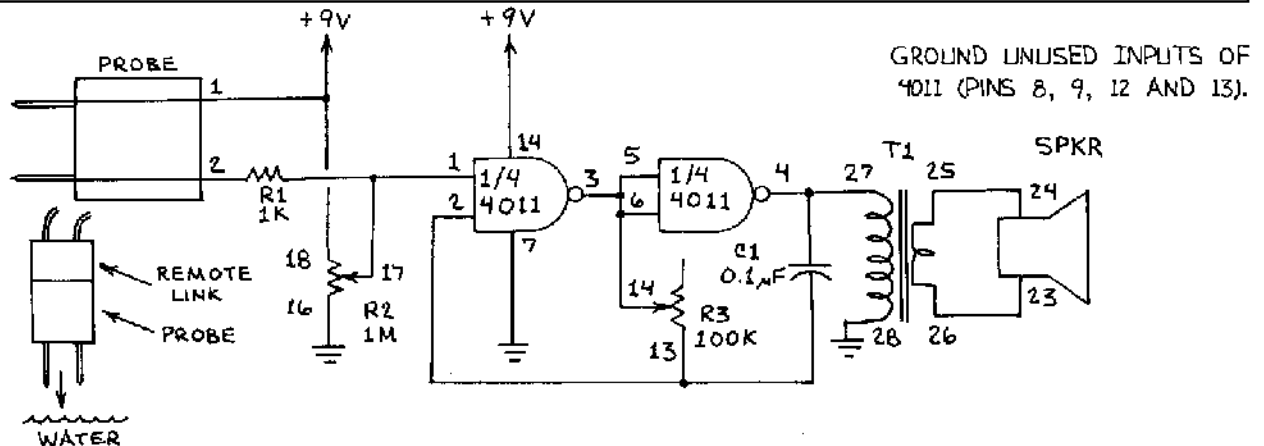

1. BUILD THE CIRCUIT

- | | |
|--|---|
| <ol style="list-style-type: none"> 1. <input type="checkbox"/> PUSH POWER AND DISPLAY SWITCHES OFF. 2. <input type="checkbox"/> INSERT PROBE CARD IN SENSOR SOCKET. 3. <input type="checkbox"/> INSERT 4011 IC ACROSS SLOT (PIN 1 AT H5). 4. <input type="checkbox"/> INSERT R1 ACROSS H2 AND A6. 5. <input type="checkbox"/> INSERT C1 ACROSS I1 AND K1. 6. <input type="checkbox"/> CONNECT N1 TO GROUND (WHT). 7. <input type="checkbox"/> CONNECT H10 TO +9V (WHT). 8. <input type="checkbox"/> CONNECT J3 TO L3 (WHT). 9. <input type="checkbox"/> CONNECT L4 TO M4 (WHT). 10. <input type="checkbox"/> CONNECT N4 TO N7 (WHT). 11. <input type="checkbox"/> CONNECT I10 TO J10 (WHT). 12. <input type="checkbox"/> CONNECT J8 TO M8 (WHT). 13. <input type="checkbox"/> CONNECT M10 TO N10 (WHT). | <ol style="list-style-type: none"> 14. <input type="checkbox"/> CONNECT SPRING 1 TO +9V (WHT). 15. <input type="checkbox"/> CONNECT SPRING 2 TO A10 (WHT). 16. <input type="checkbox"/> CONNECT SPRING 13 TO I2 (BLU). 17. <input type="checkbox"/> CONNECT SPRING 14 TO J2 (BLU). 18. <input type="checkbox"/> CONNECT SPRING 16 TO GROUND (BLU). 19. <input type="checkbox"/> CONNECT SPRING 17 TO H4 (BLU). 20. <input type="checkbox"/> CONNECT SPRING 18 TO +9V (BLU). 21. <input type="checkbox"/> CONNECT SPRING 27 TO K4 (RED). 22. <input type="checkbox"/> CONNECT SPRING 28 TO GROUND (RED). 23. <input type="checkbox"/> CONNECT SPRINGS 23 AND 26 (RED). 24. <input type="checkbox"/> CONNECT SPRINGS 24 TO 25 (WHT). |
|--|---|



2. TEST THE CIRCUIT

REMOVE ANY ELECTRICAL CHARGE FROM YOUR BODY BY TOUCHING A SCREW ON A LIGHT SWITCH OR OTHER GROUNDED OBJECT. CHECK YOUR WIRING FOR ERRORS. ROTATE THE 1M CONSOLE POTENTIOMETER R2 ALL THE WAY TO THE LEFT, THEN PUSH THE POWER SWITCH ON. ADJUST THE 100K CONSOLE POTENTIOMETER R3 TO PROVIDE THE MOST DESIRABLE TONE FROM THE SPEAKER. NOW ROTATE R2 UNTIL THE TONE JUST STOPS. TOUCH A MOISTENED FINGER TIP ACROSS THE PROBES OF THE PROBE CARD, AND THE TONE RETURNS. CONNECT THE PROBE CARD TO THE REMOTE LINK TO TEST THE CIRCUIT WITH WATER. USE A SPOONFUL OF WATER IN A SMALL PLASTIC CUP OR SOFT DRINK CAP TO AVOID SPILLING WATER ON YOUR CONSOLE.

BUILD A LED YES-NO WATER INDICATOR

YOU WILL BUILD A VERY SENSITIVE WATER AND MOISTURE SENSOR. WHEN THE PROBES OF THE PROBE CARD ARE DIPPED INTO WATER OR TOUCHED TO A MOIST SURFACE, THE GREEN LED SWITCHES OFF AND THE RED LED GLOWS.

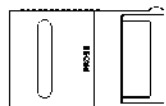
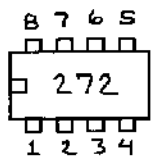
PARTS YOU WILL NEED

			
	B 7 6 5 272 1 2 3 4	R1-1M (BRN-BLK-GRN) R2-10M (BRN-BLK-BLU) R4, R5-1K (BRN-BLK-RED)	1 RED LED 1 GREEN LED

CIRCUIT DIAGRAM

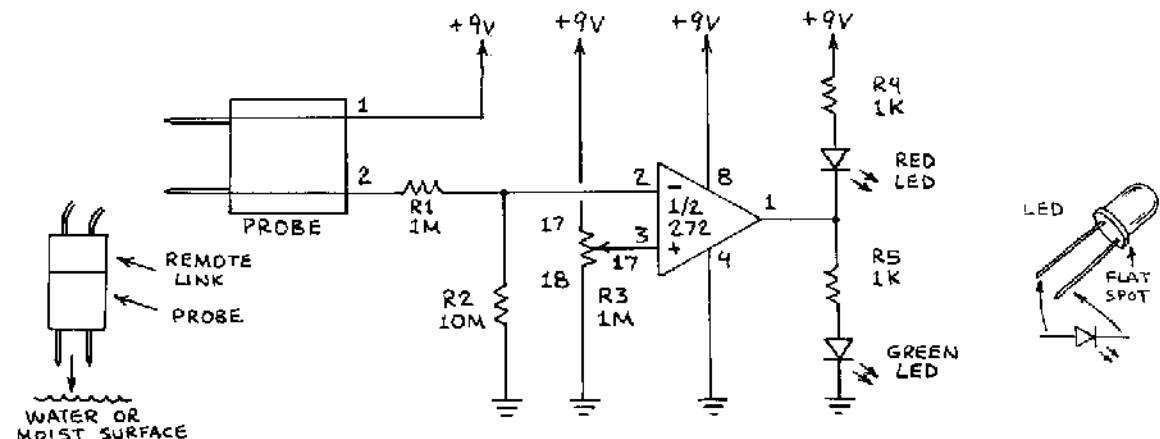

1. BUILD THE CIRCUIT

- | | |
|---|--|
| <ol style="list-style-type: none"> 1. <input type="checkbox"/> PUSH POWER AND DISPLAY SWITCHES OFF. 2. <input type="checkbox"/> INSERT PROBE CARD IN SENSOR SOCKET. 3. <input type="checkbox"/> INSERT 272 IC ACROSS SLOT (PIN 1 AT J5). 4. <input type="checkbox"/> INSERT R1 ACROSS K4 AND E6. 4. <input type="checkbox"/> INSERT R2 ACROSS K1 AND GROUND. 5. <input type="checkbox"/> INSERT R4 ACROSS I1 AND +9V 6. <input type="checkbox"/> INSERT R5 ACROSS J3 AND T3. 7. <input type="checkbox"/> INSERT RED LED ACROSS I2 (ANODE) AND J2 (CATHODE). | <ol style="list-style-type: none"> 8. <input type="checkbox"/> INSERT GREEN LED ACROSS T2 (ANODE) AND GROUND (CATHODE). 9. <input type="checkbox"/> CONNECT M4 TO GROUND (WHT). 10. <input type="checkbox"/> CONNECT J10 TO +9V (WHT). 11. <input type="checkbox"/> CONNECT SPRING 1 TO +9V (WHT). 12. <input type="checkbox"/> CONNECT SPRING 2 TO E10 (RED). 13. <input type="checkbox"/> CONNECT SPRING 16 TO J9 (BLU). 14. <input type="checkbox"/> CONNECT SPRING 17 TO L4 (BLU). 15. <input type="checkbox"/> CONNECT SPRING 18 TO GROUND (BLU). |
|---|--|

2. TEST THE CIRCUIT

REMOVE ELECTRICAL CHARGE FROM YOUR BODY BY TOUCHING A GROUNDED OBJECT. CHECK FOR ERRORS. PUSH THE POWER SWITCH ON AND ROTATE 1M CONSOLE POT R3 UNTIL THE RED LED IS OFF AND THE GREEN LED IS ON. PLACE A MOIST FINGERTIP ACROSS THE PROBES OF THE PROBE CARD. THE GREEN LED TURNS OFF, AND THE RED LED GLOWS. IF THE CIRCUIT DOES NOT WORK PROPERLY, ADJUST R3 UNTIL THE GREEN LED SWITCHES ON WHEN THE PROBES ARE NOT TOUCHING ANYTHING. THE CIRCUIT INDICATES WHEN THE PROBES ARE DIPPED INTO WATER. CONNECT THE SENSOR CARD TO THE REMOTE LINK. THE CIRCUIT IS SO SENSITIVE THAT IT INDICATES WHEN THE PROBES TOUCH YOUR HAND, EVEN IF YOUR HAND IS DRY.

3. GOING FURTHER

USE THIS CIRCUIT TO CHECK IF MATERIALS ARE GOOD INSULATORS. SUCH MATERIALS CONDUCT ELECTRICITY POORLY, IF AT ALL. ADJUST R3 FOR MAXIMUM SENSITIVITY THEN TOUCH PROBES TO THE MATERIALS TO TEST. THE GREEN LED GLOWS WHEN THE PROBES TOUCH GOOD INSULATORS LIKE GLASS, PLASTIC, AND DRY PAPER.

BUILD A PENDULUM SWITCH

PENDULUM SWITCHES ARE USED TO DETECT VIBRATIONS AND MOVEMENT. TRANSFORM THE PROBE CARD INTO A SIMPLE PENDULUM SWITCH BY HANGING THE PAPER CLIP FROM ONE OF THE PROBES. THE TONE FREQUENCY FROM THE SPEAKER FALLS WHEN THE PROBE CARD IS MOVED.

PARTS YOU WILL NEED

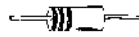
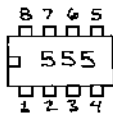
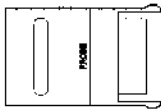

R2-10K (BRN-BLK-ORG)
R3-270 (RED-VIO-BRN)



C1, C2-0.1 UF (104)

CIRCUIT DIAGRAM

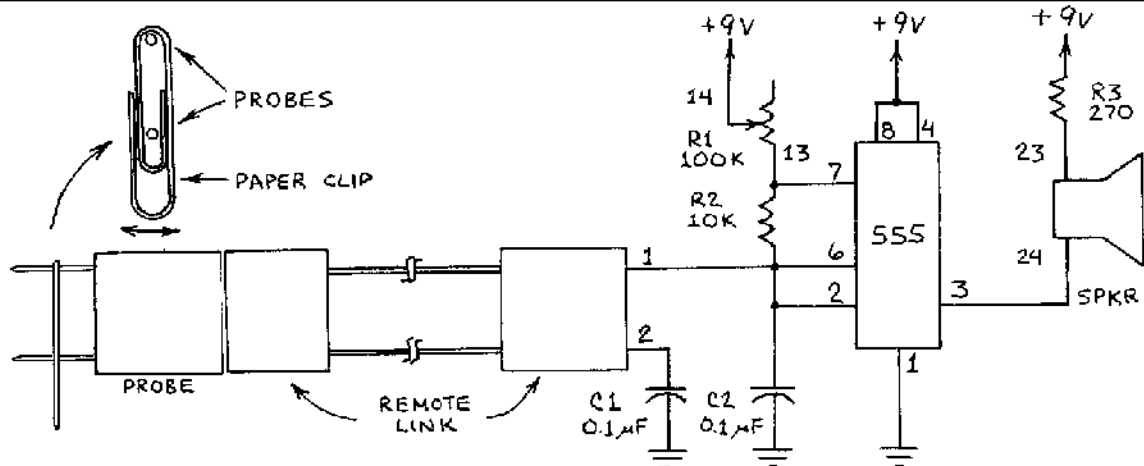

1. BUILD THE CIRCUIT

1. PUSH POWER AND DISPLAY SWITCHES OFF.
2. INSERT PROBE CARD IN REMOTE LINK SOCKET.
3. INSERT REMOTE LINK IN SENSOR SOCKET.
3. INSERT 555 IC ACROSS SLOT (PIN 1 AT Q5).
4. INSERT R1 R2 ACROSS R10 AND S10.
5. INSERT C1 ACROSS Q2 AND O2.
6. INSERT C2 ACROSS Q1 AND R1.
7. INSERT R3 ACROSS F9 AND +9V.
8. CONNECT Q3 TO GROUND (WHT).
9. CONNECT Q8 TO +9V (RED).
10. CONNECT T4 TO Q7 (WHT).
11. CONNECT R4 TO S7 (WHT).
12. CONNECT SPRING 1 TO S8 (BLU).
13. CONNECT SPRING 2 TO O5 (RED).
14. CONNECT SPRING 14 TO +9V (BLU).
15. CONNECT SPRING 13 TO R9 (RED).
16. CONNECT SPRING 23 TO F10 (RED).
17. CONNECT SPRING 24 TO S4 (BLU).

2. TEST THE CIRCUIT

REMOVE ELECTRICAL CHARGE FROM YOUR BODY. HOLD THE PROBE CARD OVER THE EDGE OF YOUR WORK SURFACE AND HANG THE PAPER CLIP FROM THE UPPER PROBE. THE PAPER CLIP SHOULD SURROUND BUT NOT TOUCH THE LOWER PROBE. PUSH THE POWER SWITCH ON. THE SPEAKER EMITS A TONE. ADJUST THE TONE FREQUENCY TO THE PREFERRED VALUE BY ROTATING 100K CONSOLE POT R1. TILT THE PROBE CARD SO THE PAPER CLIP MAKES CONTACT WITH THE LOWER PROBE. THE TONE FREQUENCY FALLS WHEN THE PAPER CLIP TOUCHES THE PROBE. TILT THE SENSOR CARD UPRIGHT, AND THE TONE RESUMES ITS ORIGINAL VALUE.

3. GOING FURTHER

THIS CIRCUIT DETECTS VIBRATIONS AND GROUND MOTION CAUSED BY WIND, INTRUDERS, OR AN EARTHQUAKE. IF YOU DON'T NEED THE "TWEE-DEL" SOUND PROVIDED BY THE 555 OSCILLATOR, CONNECT THE PROBE DIRECTLY TO THE BUZZER. CONNECT SPRING 1 TO +9V (WHT), THEN CONNECT SPRINGS 2 AND 21 (WHT). CONNECT SPRING 22 TO GROUND (BLU).

BUILD A TEMPERATURE-CONTROLLED AUDIO OSCILLATOR

SOMETIMES IT'S HELPFUL TO BE ADVISED ABOUT A SUBTLE CHANGE IN TEMPERATURE BY A TONE CHANGE RATHER THAN A VISIBLE INDICATOR SUCH AS A DIGITAL DISPLAY. YOU WILL BUILD A SIMPLE AUDIO OSCILLATOR WHOSE FREQUENCY IS DETERMINED BY TEMPERATURE.

PARTS YOU WILL NEED

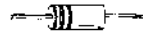
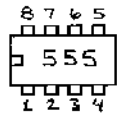
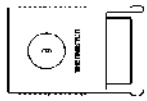

R1-10K (BRN-BLK-ORG)
R2-270 (RED-VIO-BRN)



C1-0.1 uF (104)

CIRCUIT DIAGRAM

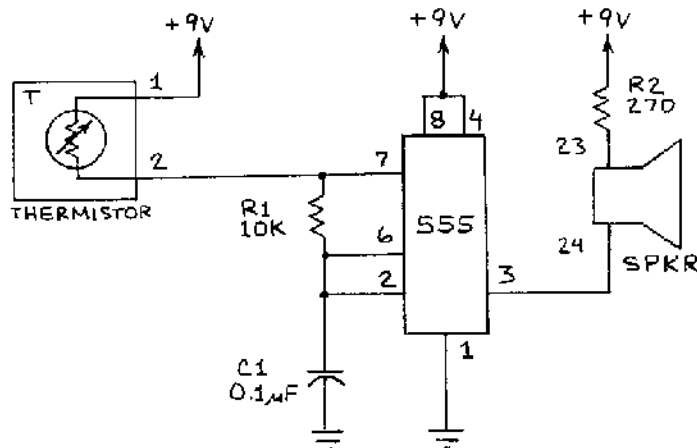

THE FREQUENCY OF 555 AUDIO OSCILLATORS IS USUALLY CHANGED BY MEANS OF A POTENTIOMETER. IN THIS CIRCUIT THE THERMISTOR PLAYS THE ROLE OF A POTENTIOMETER.

1. BUILD THE CIRCUIT

1. PUSH POWER AND DISPLAY SWITCHES OFF.
2. INSERT THERMISTOR CARD IN SENSOR SOCKET.
3. INSERT 555 IC ACROSS SLOT (PIN 1 AT Q5).
4. INSERT R1 ACROSS R10 AND S10.
5. INSERT R2 ACROSS G9 AND +9V.
6. INSERT C1 ACROSS R1 AND GROUND.
7. CONNECT Q3 TO GROUND (WHT).
8. CONNECT Q8 TO +9V (RED).
9. CONNECT R4 TO S7 (WHT).
10. CONNECT T4 TO Q7 (WHT).
11. CONNECT SPRING 1 TO +9V (WHT).
12. CONNECT SPRING 2 TO R9 (RED).
13. CONNECT SPRING 23 TO G10 (RED).
14. CONNECT SPRING 24 TO S4 (BLU).

2. TEST THE CIRCUIT

INSPECT WIRING FOR ERRORS. PUSH THE POWER SWITCH ON. YOU HEAR A TONE FROM THE SPEAKER. IF NOT, PUSH THE POWER SWITCH OFF AND CHECK FOR ERRORS. THE THERMISTOR RESISTANCE IS AROUND 10,000 OHMS, AND IT DECREASES WHEN THE THERMISTOR IS WARMED AND INCREASES WHEN THE THERMISTOR IS COOLED. IF YOU WARM THE THERMISTOR CARD BY BLOWING ON IT, THE TONE FREQUENCY RISES. HEAT FROM SUNLIGHT HAS THE SAME EFFECT. FOR A MORE DRAMATIC DEMONSTRATION, CONNECT THE THERMISTOR CARD TO THE CONSOLE USING THE REMOTE LINK. HOLD THE SENSOR CARD NEAR AIR FROM AN AIR CONDITIONER OR HEATER. THE TONE FREQUENCY FALLS RAPIDLY WHEN THE CARD IS COOLED AND RISES RAPIDLY WHEN THE CARD IS HEATED. MOVE THE CARD AWAY FROM THE AIR, AND THE FREQUENCY OF THE TONE GRADUALLY RETURNS TO ITS PREVIOUS VALUE.

CAUTION: DO NOT PLACE SENSOR CARDS, REMOTE LINK, OR CONSOLE IN LIQUIDS NEAR A FLAME, SOLDERING IRON, HAIR DRYER, OR OTHER HEAT SOURCE. LIQUIDS AND EXCESSIVE HEAT MAY DAMAGE THE PLASTIC COMPONENTS AND DELICATE SENSORS. NEVER SPRAY ANY CHEMICAL INTENDED TO COOL OBJECTS ON THE SENSOR CARDS, REMOTE LINK, OR CONSOLE. CHEMICALS MAY DAMAGE AND DISCOLOR PLASTIC.

BUILD A TEMPERATURE-CONTROLLED THERMOSTAT

THERMOSTATS ARE ELECTRONIC OR ELECTRO-MECHANICAL DEVICES THAT SENSE TEMPERATURE. THEY SWITCH A HEATING OR COOLING DEVICE ON OR OFF WHEN THE TEMPERATURE STRAYS FROM A DESIRED LEVEL. YOU WILL BUILD A BASIC THERMOSTAT THAT SWITCHES ON A LED WHEN TEMPERATURE EXCEEDS A PRESET VALUE.

PARTS YOU WILL NEED

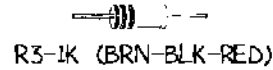
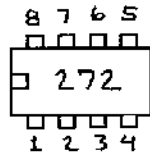
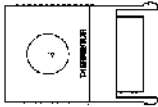

CIRCUIT DIAGRAM

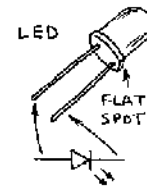
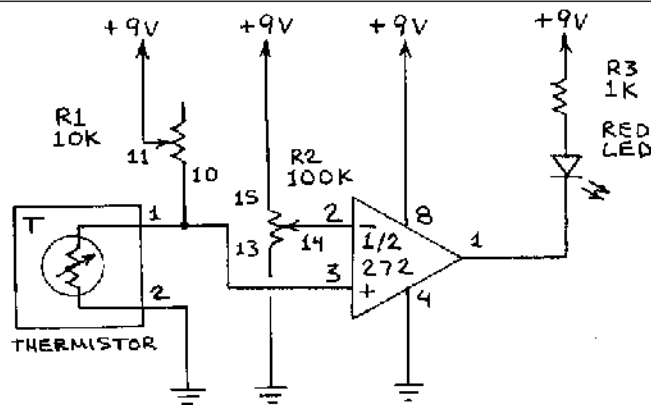

1. BUILD THE CIRCUIT

1. PUSH POWER AND DISPLAY SWITCHES OFF.
2. INSERT THERMISTOR CARD IN SENSOR SOCKET.
3. INSERT 272 IC ACROSS SLOT (PIN 1 AT J5).
4. INSERT R3 ACROSS H5 AND +9V.
5. INSERT LED ACROSS H1 (ANODE) AND J1 (CATHODE).
6. CONNECT M1 TO GROUND (WHT).
7. CONNECT J10 TO +9V (WHT).
8. CONNECT SPRING 1 TO L4 (RED).
9. CONNECT SPRING 2 TO GROUND (RED).
10. CONNECT SPRING 10 TO L1 (RED).
11. CONNECT SPRING 11 TO J8 (RED).
12. CONNECT SPRING 13 TO GROUND (RED).
13. CONNECT SPRING 14 TO K1 (BLU).
14. CONNECT SPRING 15 TO +9 V (BLU).

2. TEST THE CIRCUIT

CHECK THE CIRCUIT FOR ERRORS AND ADJUST 10K CONSOLE POT R1 TO ITS MID-POINT. PUSH THE POWER SWITCH ON. ADJUST 100K CONSOLE POT R2 UNTIL THE LED JUST SWITCHES OFF. WHEN THE THERMISTOR SENSOR CARD IS WARMED ABOVE ITS PRESENT TEMPERATURE, THE LED GLOWS. ADJUST R1 TO CONTROL THE CIRCUIT SENSITIVITY RANGE. CAUTION: DO NOT PLACE SENSOR CARDS, REMOTE LINK, OR CONSOLE IN LIQUIDS OR NEAR A FLAME, SOLDERING IRON, HAIR DRYER, OR OTHER HEAT SOURCE. LIQUIDS AND EXCESSIVE HEAT MAY DAMAGE THE PLASTIC COMPONENTS AND DELICATE SENSORS. NEVER SPRAY ANY CHEMICAL INTENDED TO COOL OBJECTS ON THE SENSOR CARDS, REMOTE LINK, OR CONSOLE. SUCH CHEMICALS MAY DAMAGE AND DISCOLOR PLASTIC.

3. GOING FURTHER

YOU CAN MODIFY THE CIRCUIT TO SWITCH THE LED OFF WHEN TEMPERATURE RISES. PUSH THE POWER SWITCH OFF AND SWITCH THE CONNECTIONS TO PINS 2 AND 3 OF THE 272 OP AMP. PUSH THE POWER SWITCH ON AND ADJUST R2 UNTIL THE LED JUST GLOWS.

BUILD A TEMPERATURE CONTROLLED BUZZER

BUILD A THERMOSTAT-STYLE CIRCUIT THAT STOPS THE CONSOLE BUZZER WHEN THE THERMISTOR TEMPERATURE EXCEEDS A PRESET VALUE. COMPARE THE CIRCUIT DIAGRAM BELOW WITH THE ONE ON PAGE 75. BOTH USE THE SAME INPUT COMPONENTS AND CONNECTIONS.

PARTS YOU WILL NEED

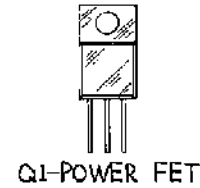
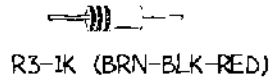
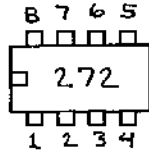
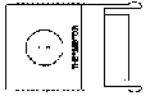

CIRCUIT DIAGRAM

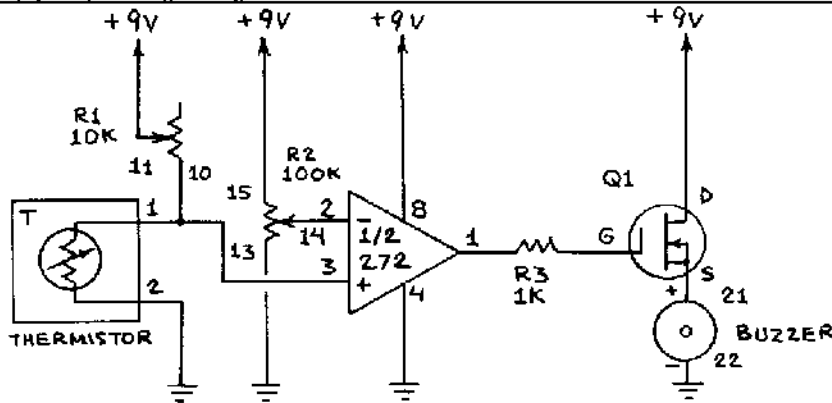

1. BUILD THE CIRCUIT

1. PUSH POWER AND DISPLAY SWITCHES OFF.
2. INSERT THERMISTOR CARD IN SENSOR SOCKET.
3. INSERT 272 IC ACROSS SLOT (PIN 1 AT J5).
4. INSERT Q1 AT A1 (S), B1 (D) AND C1 (G).
5. INSERT R3 ACROSS C4 AND J4.
6. CONNECT M1 TO GROUND (WHT).
7. CONNECT J10 TO +9V (WHT).
8. CONNECT B5 TO +9V (WHT).
9. CONNECT SPRING 1 TO L4 (RED).
10. CONNECT SPRING 2 TO M4 (RED).
11. CONNECT SPRING 10 TO L1 (RED).
12. CONNECT SPRING 11 TO +9V (BLU).
13. CONNECT SPRING 13 TO GROUND (RED).
14. CONNECT SPRING 14 TO K4 (BLU).
15. CONNECT SPRING 15 TO +9V (BLU).
16. CONNECT SPRING 21 TO A5 (RED).
17. CONNECT SPRINGS 2 AND 22 (WHT).

2. TEST THE CIRCUIT

CORRECT ANY WIRING ERRORS. ADJUST 10K CONSOLE POT R1 TO ITS MID-POINT. PUSH THE POWER SWITCH ON AND ADJUST 100K CONSOLE POT R2 UNTIL THE BUZZER SOUNDS. THE BUZZER STOPS SOUNDING WHEN THE THERMISTOR TEMPERATURE RISES.

CAUTION: DO NOT PLACE SENSOR CARDS, REMOTE LINK, OR CONSOLE IN LIQUIDS OR NEAR A FLAME, SOLDERING IRON, HAIR DRYER OR OTHER HEAT SOURCE. LIQUIDS AND EXCESSIVE HEAT MAY DAMAGE THE PLASTIC COMPONENTS AND DELICATE SENSORS. NEVER SPRAY ANY CHEMICAL INTENDED TO COOL OBJECTS ON THE SENSOR CARDS, REMOTE LINK OR CONSOLE. SUCH CHEMICALS MAY DAMAGE AND DISCOLOR PLASTIC.

3. GOING FURTHER

YOU CAN REVERSE THE CIRCUIT OPERATION SO THE BUZZER SOUNDS WHEN THE TEMPERATURE RISES. AS WITH THE LED ON PAGE 75, JUST SWITCH THE CONNECTIONS TO PINS 2 AND 3 OF THE 272 OP AMP.

BUILD A REMOTE TEMPERATURE TRANSMITTER

YOU WILL BUILD A TRANSMITTER THAT SENDS THE TEMPERATURE OF THE THERMISTOR SENSOR CARD BY FLASHING AN LED. THE NUMBER OF FLASHES IS PROPORTIONAL TO THE TEMPERATURE, AND THEY ARE SLOW ENOUGH TO COUNT THEM.

PARTS YOU WILL NEED

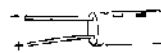
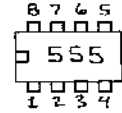
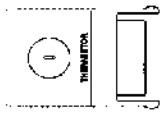

C1-100 UF

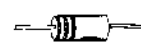

R1-2.2K (RED-RED-RED)
R2-470 (YEL-VIO-BRN)

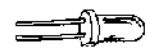

1 RED LED

CIRCUIT DIAGRAM

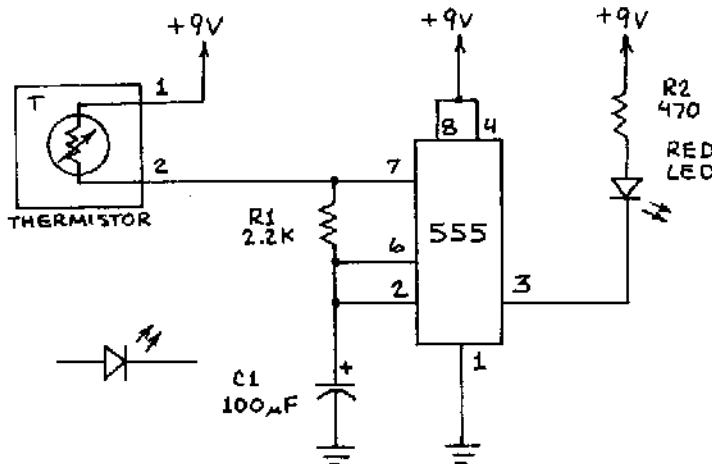

1. BUILD THE CIRCUIT

- PUSH POWER AND DISPLAY SWITCHES OFF.
- INSERT THERMISTOR CARD IN SENSOR SOCKET.
- INSERT 555 IC ACROSS SLOT (PIN 1 AT Q5).
- INSERT C1 ACROSS R2 (+) AND Q2 (-).
- INSERT LED ACROSS P1 (ANODE) AND S1 (CATHODE).
- INSERT R1 ACROSS R10 AND S10.
- INSERT R2 ACROSS P5 AND Q9.
- CONNECT Q3 TO GROUND (WHT).
- CONNECT Q10 TO +9V (RED).
- CONNECT R4 TO S7 (WHT).
- CONNECT T4 TO Q7 (WHT).
- CONNECT SPRING 1 TO +9V (WHT).
- CONNECT SPRING 2 TO R9 (RED).

2. TEST THE CIRCUIT

CHECK FOR WIRING ERRORS. PUSH THE POWER SWITCH ON. THE LED SLOWLY FLASHES. THE ACTUAL TEMPERATURE (FAHRENHEIT) IS ABOUT 2 TIMES THE NUMBER OF FLASHES IN 60 SECONDS. AN EXACT CALIBRATION CANNOT BE GIVEN BECAUSE OF SLIGHT VARIATIONS IN THE VALUES OF THE THERMISTOR AND C1. CAUTION: DO NOT PLACE SENSOR CARDS, REMOTE LINK, OR CONSOLE IN LIQUIDS OR NEAR A FLAME, SOLDERING IRON, HAIR DRYER, OR OTHER HEAT SOURCE. LIQUIDS AND EXCESSIVE HEAT MAY DAMAGE THE PLASTIC COMPONENTS AND DELICATE SENSORS. NEVER SPRAY ANY CHEMICAL INTENDED TO COOL OBJECTS ON THE SENSOR CARDS, REMOTE LINK, OR CONSOLE. SUCH CHEMICALS MAY DAMAGE AND DISCOLOR PLASTIC.

3. GOING FURTHER

YOU CAN CALIBRATE THIS CIRCUIT WITH A THERMOMETER. PLACE THE THERMOMETER AND THE THERMISTOR CARD IN A REFRIGERATOR. AFTER ABOUT 15 MINUTES, REMOVE THE THERMOMETER AND NOTE ITS TEMPERATURE. INSERT THE THERMISTOR CARD IN THE CONSOLE AND COUNT THE FLASHES FOR 60 SECONDS. REPEAT THESE STEPS, PLACING THE THERMISTOR CARD AND THERMOMETER IN AN AIR CONDITIONED ROOM AND IN A SHADY SPOT OUTDOORS. GRAPH YOUR DATA, WITH THE X AXIS ON THE BOTTOM FOR TEMPERATURE AND THE Y AXIS ON THE LEFT FOR NUMBER OF FLASHES. CONNECT THE POINTS. USE YOUR GRAPH TO MEASURE THE THERMISTOR TEMPERATURE BY COUNTING THE FLASHES FOR 1 MINUTE. AT NIGHT YOU CAN SEE THE FLASHING LED FROM A CONSIDERABLE DISTANCE.

BUILD A TEMPERATURE-CONTROLLED CHIRP GENERATOR

THE CONSOLE BUZZER DOES ITS JOB BY GETTING YOUR ATTENTION. SOFTEN ITS IMPACT BY BUILDING THIS CIRCUIT THAT INDICATES TEMPERATURE WITH A SERIES OF CHIRPS.

PARTS YOU WILL NEED

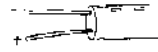
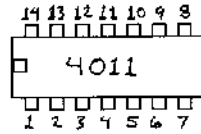
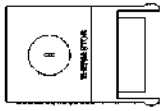

C1-100 UF
C2-4.7 UF

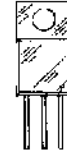

Q1-POWER FET

CIRCUIT DIAGRAM

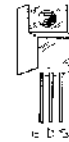
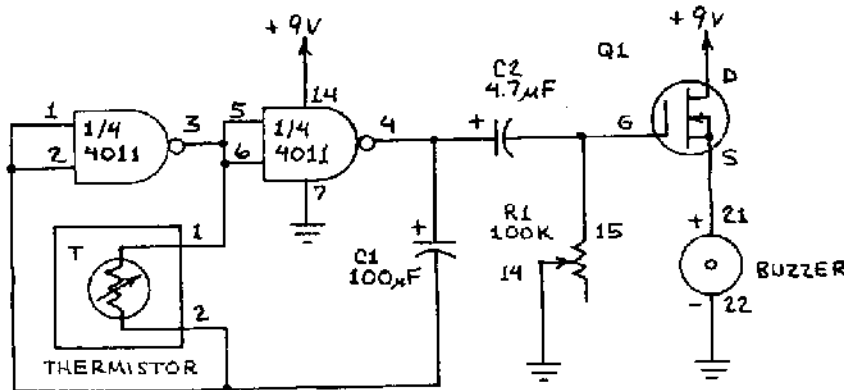

GROUND UNUSED INPUTS OF 4011 (PINS 8, 9, 12 AND 13).

1. BUILD THE CIRCUIT

1. PUSH POWER AND DISPLAY SWITCHES OFF.
2. INSERT THERMISTOR CARD IN SENSOR SOCKET.
3. INSERT 4011 IC ACROSS SLOT (PIN 1 AT H5).
4. INSERT Q1 AT A1 (S), B1 (D) AND C1 (G).
5. INSERT C1 ACROSS K1 (+) AND I1 (-).
6. INSERT C2 ACROSS K2 (+) AND C2 (-).
7. CONNECT N1 TO GROUND (WHT).
8. CONNECT H10 TO +9V (WHT).
9. CONNECT B5 TO +9V (WHT).
10. CONNECT H4 TO I4 (WHT).
11. CONNECT J3 TO L3 (WHT).
12. CONNECT L4 TO M4 (WHT).
13. CONNECT N4 TO N7 (WHT).
14. CONNECT I10 TO J10 (WHT).
15. CONNECT J8 TO M8 (WHT).
16. CONNECT M10 TO N10 (WHT).
17. CONNECT SPRING 1 TO L1 (RED).
18. CONNECT SPRING 2 TO H3 (RED).
19. CONNECT SPRING 14 TO GROUND (RED).
20. CONNECT SPRING 15 TO C5 (BLU).
21. CONNECT SPRING 21 TO A5 (RED).
22. CONNECT SPRING 22 TO GROUND (BLU).

2. TEST THE CIRCUIT

CHECK FOR ERRORS. PUSH THE POWER SWITCH ON, AND THE BUZZER EMITS BRIEF PULSES OF SOUND. ADJUST 100K CONSOLE POTENTIOMETER R1 TO PROVIDE THE BEST SOUNDING CHIRPS. A CHANGE IN TEMPERATURE WILL CHANGE THE CHIRP RATE.

CAUTION: DO NOT PLACE SENSOR CARDS, REMOTE LINK, OR CONSOLE IN LIQUIDS OR NEAR A FLAME, SOLDERING IRON, HAIR DRYER, OR OTHER SOURCE OF HEAT. LIQUIDS AND EXCESSIVE HEAT MAY DAMAGE THE PLASTIC COMPONENTS AND THE DELICATE SENSORS. NEVER SPRAY ON THE SENSOR CARDS, REMOTE LINK OR CONSOLE ANY CHEMICAL INTENDED TO COOL OBJECTS. SUCH CHEMICALS MAY DAMAGE AND DISCOLOR PLASTIC.

3. GOING FURTHER

SEE PAGE 77 FOR TIPS ABOUT CALIBRATING THIS CIRCUIT.

BUILD A TEMPERATURE-CONTROLLED BARGRAPH READOUT

THE BARGRAPH READOUT CAN BE USED TO MAKE AN ELECTRONIC THERMOMETER THAT RESEMBLES A CONVENTIONAL LIQUID-FILLED THERMOMETER TUBE. YOU WILL BUILD A CIRCUIT THAT USES THE BARGRAPH READOUT IN THIS MANNER.

PARTS YOU WILL NEED

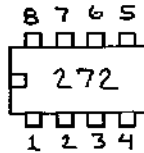
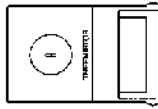

R2, R3-1K (BRN-BLK-RED)

CIRCUIT DIAGRAM

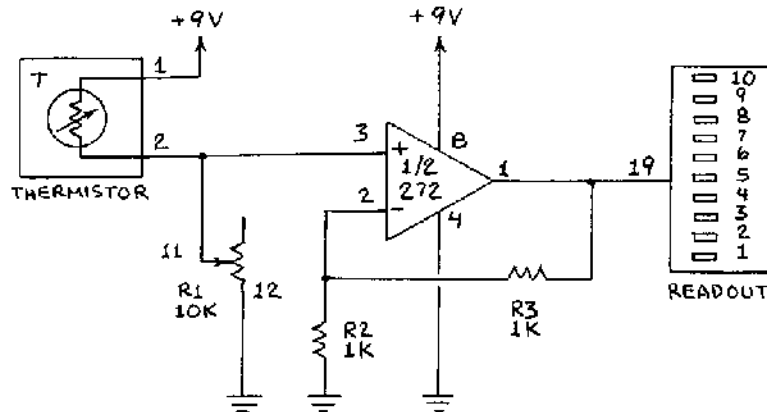

1. BUILD THE CIRCUIT

1. PUSH POWER AND DISPLAY SWITCHES OFF.
2. INSERT THERMISTOR CARD IN SENSOR SOCKET.
3. INSERT 272 IC ACROSS SLOT (PIN 1 AT J5).
4. INSERT R2 ACROSS K2 AND GROUND.
5. INSERT R3 ACROSS J1 AND K1.
6. CONNECT M1 TO GROUND (WHT).
7. CONNECT J10 TO +9V (WHT).
8. CONNECT SPRING 1 TO +9V (WHT).
9. CONNECT SPRING 2 TO L4 (RED).
10. CONNECT SPRING 11 TO L3 (BLU).
11. CONNECT SPRING 12 TO GROUND (RED).
12. CONNECT SPRING 19 TO J2 (RED).

2. TEST THE CIRCUIT

CHECK YOUR WIRING FOR ERRORS. PUSH THE POWER SWITCH ON AND DISPLAY MODE SWITCH TO DOT. ADJUST 10K CONSOLE POT UNTIL A READOUT LED BETWEEN 2 AND 9 GLOWS. THE LED DOT RISES WHEN THE THERMISTOR IS WARMED AND FALLS WHEN COOLED. THE RESPONSE TIME IS SLOWER FOR LIGHT SENSOR CIRCUITS THAT USE THE READOUT. YOU CAN SWITCH THE DISPLAY MODE SWITCH TO BARGRAPH, LIKE A THERMOMETER. SWITCH THE DISPLAY MODE OFF WHEN THE CIRCUIT IS NOT IN USE. **CAUTION!** DO NOT PLACE SENSOR CARDS, REMOTE LINK, OR CONSOLE IN LIQUIDS OR NEAR A FLAME, SOLDERING IRON, HAIR DRYER OR OTHER HEAT SOURCE. LIQUIDS AND EXCESSIVE HEAT MAY DAMAGE THE PLASTIC COMPONENTS AND THE DELICATE SENSORS. NEVER SPRAY ANY CHEMICAL INTENDED TO COOL OBJECTS ON THE SENSOR CARDS, REMOTE LINK OR CONSOLE. SUCH CHEMICALS MAY DAMAGE AND DISCOLOR PLASTIC.

3. GOING FURTHER

SPRING 29 IS INTERNALLY CONNECTED TO READOUT LED 10, MEANING YOU CAN TRIGGER AN EXTERNAL CIRCUIT WHEN THE TEMPERATURE REACHES 10. INSERT THE GREEN LED ACROSS +9V (ANODE) AND A6 (CATHODE). CONNECT SPRING 29 TO A10 (BLU). THE GREEN LED GLOWS WHEN READOUT LED 10 GLOWS.

BUILD A LIGHT-ACTIVATED BUZZER

LIGHT-ACTIVATED BUZZERS HAVE MANY USES. YOU WILL USE THE PHOTORESISTOR SENSOR CARD AND A 272 OPERATIONAL AMPLIFIER CONNECTED AS A COMPARATOR TO MAKE A SIMPLE LIGHT-ACTIVATED BUZZER.

PARTS YOU WILL NEED

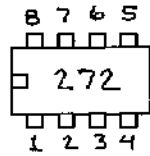
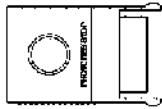

R1-10K (BRN-BLK-ORG)
R3-1K (BRN-BLK-RED)



Q1-
POWER FET

CIRCUIT DIAGRAM

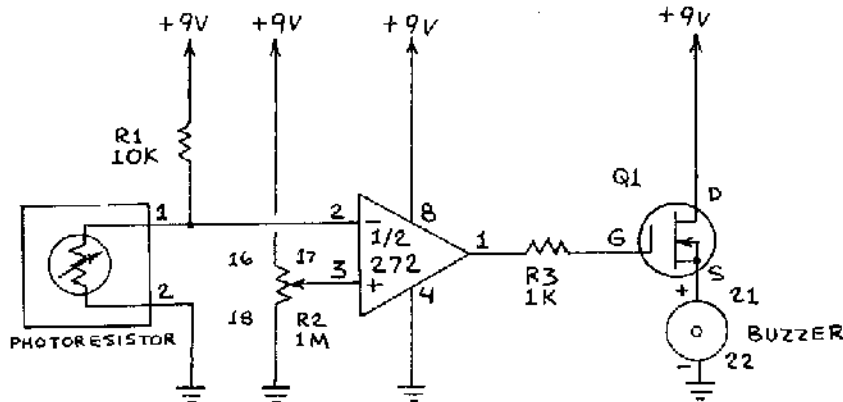

1. BUILD THE CIRCUIT

1. PUSH THE POWER AND DISPLAY SWITCHES OFF.
2. INSERT PHOTORESISTOR CARD IN SENSOR SOCKET.
3. INSERT 272 IC ACROSS SLOT (PIN 1 AT J5).
4. INSERT Q1 AT C1 (G), B1 (D) AND A1 (S).
5. INSERT R1 ACROSS SPRING 1 AND +9V.
6. INSERT R3 ACROSS C4 AND J4.
7. CONNECT M1 TO GROUND (WHT).
8. CONNECT J10 TO +9V (WHT).
9. CONNECT B3 TO +9V (WHT).
10. CONNECT SPRING 1 TO K1 (RED).
11. CONNECT SPRING 2 TO GROUND (RED).
12. CONNECT SPRING 16 TO -9V (BLU).
13. CONNECT SPRING 17 TO L1 (BLU).
14. CONNECT SPRING 18 TO GROUND (BLU).
15. CONNECT SPRING 21 TO A5 (RED).
16. CONNECT SPRING 22 TO GROUND (BLU).

2. TEST THE CIRCUIT

CHECK YOUR WIRING FOR ERRORS. BE SURE THAT POWER FET Q1 IS INSTALLED CORRECTLY WITH ITS FRONT SIDE FACING THE RIGHT SIDE OF THE CONSOLE. ALLOW LIGHT TO STRIKE THE PHOTORESISTOR SENSOR CARD. PUSH THE POWER SWITCH ON, THEN ADJUST 1M CONSOLE POTENTIOMETER R2 UNTIL THE BUZZER SOUNDS. SHADE THE PHOTORESISTOR CARD, AND THE BUZZER SWITCHES OFF. IF THE BUZZER CONTINUES TO SOUND WHEN THE PHOTORESISTOR IS SHADED, ADJUST R2 OR THE LIGHT LEVEL UNTIL THE CIRCUIT WORKS PROPERLY.

3. GOING FURTHER

YOU CAN EASILY CHANGE THIS CIRCUIT TO A DARK ACTIVATED BUZZER. FIRST, PUSH THE POWER SWITCH OFF, THEN SWITCH THE CONNECTIONS FOR R2 AND THE PHOTORESISTOR. REPEAT THE ADJUSTMENT PROCEDURE ABOVE TO CAUSE THE BUZZER TO SOUND WHEN THE PHOTORESISTOR IS SHADED.

BUILD A LIGHT OR DARK ACTIVATED TONE

YOU WILL BUILD A CIRCUIT THAT EMITS A TONE WHEN STRUCK BY LIGHT.

PARTS YOU WILL NEED

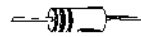
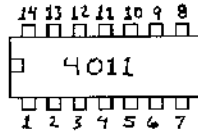
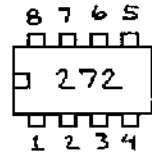
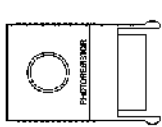

R1-10K (BRN-BLK-ORG)



C1-0.1 UF (104)

CIRCUIT DIAGRAM

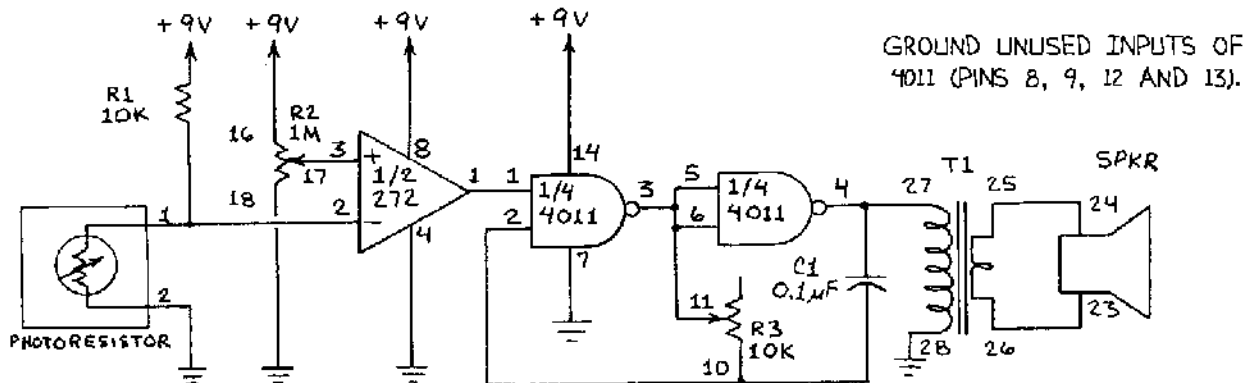

1. BUILD THE CIRCUIT

1. PUSH POWER AND DISPLAY SWITCHES OFF.
2. INSERT PHOTORESISTOR CARD IN SENSOR SOCKET.
3. INSERT 272 IC ACROSS SLOT (PIN 1 AT E5).
4. INSERT 4011 IC ACROSS SLOT (PIN 1 AT N5).
5. INSERT R1 ACROSS F4 AND E7.
6. INSERT C1 ACROSS O1-Q1.
7. CONNECT H1 TO GROUND (RED).
8. CONNECT E10 TO +9V (WHT).
9. CONNECT T4 TO GROUND (WHT).
10. CONNECT N9 TO +9V (RED).
11. CONNECT E4 TO N4 (WHT).
12. CONNECT P3 TO R3 (WHT).
13. CONNECT R2 TO S2 (WHT).
14. CONNECT O10 TO P10 (WHT).
15. CONNECT P9 TO S9 (WHT).
16. CONNECT S10 TO T10 (WHT).
17. CONNECT T9 TO GROUND (WHT).
18. CONNECT SPRING 1 TO F1 (RED).
19. CONNECT SPRING 2 TO GROUND (BLU).
20. CONNECT SPRING 10 TO O2 (RED).
21. CONNECT SPRING 11 TO P2 (RED).
22. CONNECT SPRING 16 TO +9V (BLU).
23. CONNECT SPRING 17 TO G1 (BLU).
24. CONNECT SPRING 18 TO GROUND (BLU).
25. CONNECT SPRINGS 23 AND 26 (RED).
26. CONNECT SPRINGS 24 AND 25 (WHT).
27. CONNECT SPRING 27 TO Q4 (RED).
28. CONNECT SPRING 28 TO GROUND (BLU).

2. TEST THE CIRCUIT

CHECK FOR ERRORS. PUSH THE POWER SWITCH ON. SHADE THE PHOTORESISTOR WITH YOUR HAND. ROTATE THE 1M CONSOLE POT (R2) UNTIL THE BUZZER IS OFF. MOVE YOUR HAND, AND THE BUZZER SOUNDS. ADJUST THE 10K CONSOLE POT (R3) TO CHANGE THE FREQUENCY OF THE TONE.

BUILD A LIGHT-INCREASES-FREQUENCY AUDIO OSCILLATOR

AS YOU KNOW BY NOW, THE 555 TIMER IC PROVIDED WITH YOUR ELECTRONIC SENSORS LAB IS IDEAL FOR MAKING MANY DIFFERENT KINDS OF TONE GENERATORS. YOU WILL CONNECT THE PHOTORESISTOR SENSOR CARD TO THE 555 TO MAKE A LIGHT-SENSITIVE OSCILLATOR.

PARTS YOU WILL NEED

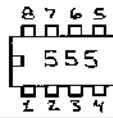
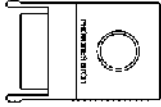

R1-10K (BRN-BLK-ORG)
R2-150 (BRN-GRN-BRN)

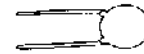

C1-0.01 uF (103)

CIRCUIT DIAGRAM

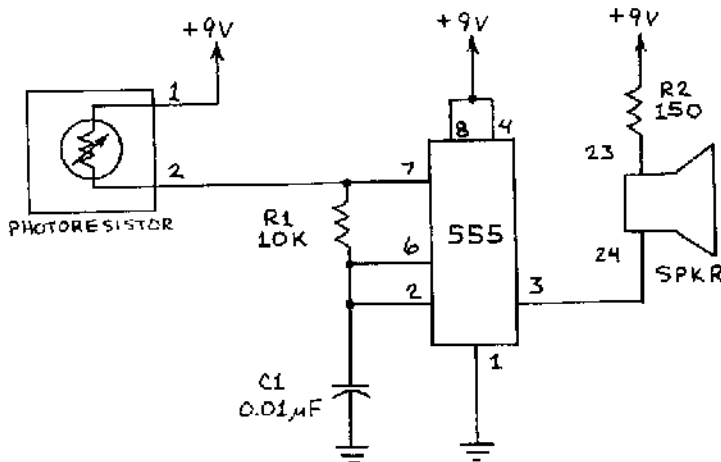

1. BUILD THE CIRCUIT

- PUSH POWER AND DISPLAY SWITCHES OFF.
- INSERT 555 IC ACROSS SLOT (PIN 1 AT Q5).
- INSERT R1 ACROSS R10 AND S10.
- INSERT R2 ACROSS G9 AND +9V.
- INSERT C1 ACROSS Q1 AND R1.
- CONNECT Q3 AND GROUND (WHT).
- CONNECT Q10 TO +9V (RED).
- CONNECT R4 AND S7 (WHT).
- CONNECT T4 AND Q7 (WHT).
- CONNECT SPRING 1 TO +9V (WHT).
- CONNECT SPRING 2 TO R7 (RED).
- CONNECT SPRING 23 TO G10 (RED).
- CONNECT SPRING 24 TO S4 (RED).

2. TEST THE CIRCUIT

CHECK YOUR WIRING FOR POSSIBLE ERRORS. PUSH THE POWER SWITCH ON. YOU SHOULD HEAR A TONE FROM THE SPEAKER. IF NOT, SHADE THE PHOTORESISTOR CARD WITH YOUR HAND TO INCREASE ITS RESISTANCE. WHEN YOU HEAR A TONE, SHADE THE PHOTORESISTOR WITH YOUR HAND OR DIM THE ROOM LIGHTS TO OBSERVE HOW THE FREQUENCY OF THE TONE CHANGES WITH THE LIGHT LEVEL.

3. GOING FURTHER

YOU CAN EASILY ALTER THE BASIC TONE FREQUENCY BY CHANGING C1. USE A HIGHER VALUE FOR A LOWER FREQUENCY TONE. THE - LEAD OF ELECTROLYTIC CAPACITORS MUST GO TO PIN 2 OF THE 555. IF THE SPEAKER VOLUME IS TOO HIGH, INCREASE R2 TO 270 (RED-VIO-BRN) OR 470 OHMS (YEL-VIO-BRN).

HERE'S AN INTERESTING EXPERIMENT TO TRY. CHANGE C1 TO A LARGER VALUE SO THAT THE SPEAKER CLICKS OR BUZZES WHEN THE PHOTORESISTOR IS DARK. PLACE THE CONSOLE IN A LARGE DARKENED ROOM OR OUTDOORS. NOW STAND SOME DISTANCE AWAY AND POINT A FLASHLIGHT TOWARD, BUT NOT AT, THE PHOTORESISTOR. CHANGES IN THE CLICK RATE OR BUZZ FREQUENCY PROVIDE A VERY SENSITIVE INDICATION OF THE PRESENCE OF LIGHT.

BUILD A LIGHT-REDUCES-FREQUENCY AUDIO OSCILLATOR

THE BASIC 555 AUDIO OSCILLATOR DESCRIBED ON PAGE 82 CAN BE MODIFIED TO PROVIDE AN OSCILLATOR IN WHICH THE TONE FREQUENCY DECREASES WHEN THE PHOTORESISTOR IS ILLUMINATED. YOU WILL BUILD THIS CIRCUIT NEXT.

PARTS YOU WILL NEED

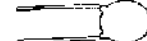
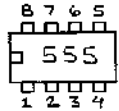
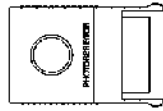

R3-10K (BRN-BLK-ORG)
R4-150 (BRN-GRN-BRN)

C1-0.1 UF (104)

CIRCUIT DIAGRAM

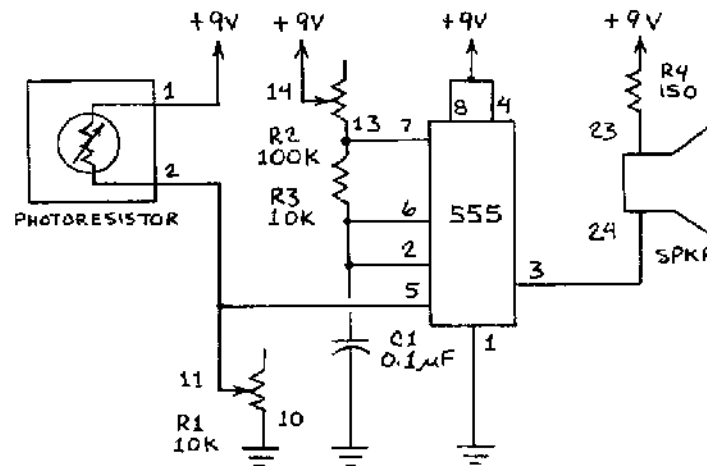

1. BUILD THE CIRCUIT

- | | |
|--|---|
| 1. <input type="checkbox"/> PUSH POWER AND DISPLAY SWITCHES OFF. | 10. <input type="checkbox"/> CONNECT SPRING 1 TO +9V (WHT). |
| 2. <input type="checkbox"/> INSERT 555 IC ACROSS SLOT (PIN 1 AT Q5). | 11. <input type="checkbox"/> CONNECT SPRING 2 TO T10 (RED). |
| 3. <input type="checkbox"/> INSERT R3 ACROSS R10 AND S10. | 12. <input type="checkbox"/> CONNECT SPRING 10 TO GROUND (RED). |
| 4. <input type="checkbox"/> INSERT R4 ACROSS G9 AND +9V. | 13. <input type="checkbox"/> CONNECT SPRING 11 TO T7 (RED). |
| 5. <input type="checkbox"/> INSERT C1 ACROSS Q1 AND R1. | 14. <input type="checkbox"/> CONNECT SPRING 13 TO R8 (RED). |
| 6. <input type="checkbox"/> CONNECT Q3 AND GROUND (WHT). | 15. <input type="checkbox"/> CONNECT SPRING 14 TO +9V (BLU). |
| 7. <input type="checkbox"/> CONNECT Q10 TO +9V (RED). | 16. <input type="checkbox"/> CONNECT SPRING 23 TO G10 (RED). |
| 8. <input type="checkbox"/> CONNECT R4 AND S7 (WHT). | 17. <input type="checkbox"/> CONNECT SPRING 24 TO S4 (RED). |
| 9. <input type="checkbox"/> CONNECT T4 AND Q7 (WHT). | |

2. TEST THE CIRCUIT

REVIEW THE CIRCUIT FOR POSSIBLE ERRORS. BE SURE THAT EXPOSED COMPONENT LEADS DO NOT TOUCH ONE ANOTHER. ADJUST 10K CONSOLE POTENTIOMETER R1 TO ITS MID-POINT. PUSH THE POWER SWITCH ON. YOU SHOULD HEAR A TONE FROM THE SPEAKER. IF NOT, SHADE THE PHOTORESISTOR CARD WITH YOUR HAND WHILE ADJUSTING CONSOLE POTENTIOMETERS R1 (10K) OR R2 (100K). ADJUSTING BOTH POTENTIOMETERS MAY BE NECESSARY. WHEN THE CIRCUIT IS OSCILLATING, SHADE THE PHOTORESISTOR TO OBSERVE HOW THE FREQUENCY OF THE TONE FALLS WHEN LIGHT STRIKES THE PHOTORESISTOR.

3. GOING FURTHER

YOU CAN CONTROL THIS CIRCUIT BY ADJUSTING THE 10K CONSOLE POTENTIOMETER R1. THIS POT AND THE PHOTORESISTOR FORM A VOLTAGE DIVIDER THAT DELIVERS A VOLTAGE TO THE 555 CONTROL INPUT (PIN 5). LIGHT CHANGES AND THE SETTING OF R1 CHANGE THIS VOLTAGE. TRY DISCONNECTING THE WIRE AT PIN 5 TO SEE WHAT HAPPENS.

BUILD AN OBJECT DETECTOR

MANY DIFFERENT SENSOR CIRCUITS CAN BE USED TO DETECT NEARBY OBJECTS. YOU WILL USE THE PHOTORESISTOR SENSOR CARD TO BUILD AN OBJECT DETECTOR. A GREEN LED GLOWS WHEN AN OBJECT IS PLACED BEFORE THE PHOTORESISTOR. THE RED LED GLOWS WHEN THE OBJECT IS MOVED.

PARTS YOU WILL NEED

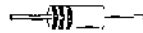
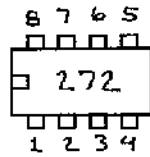
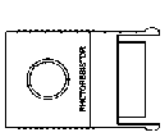

R1-10K (BRN-BLK-ORG)
R3, R4-1K (BRN-BLK-RED)

1 RED LED
1 GREEN LED

CIRCUIT DIAGRAM

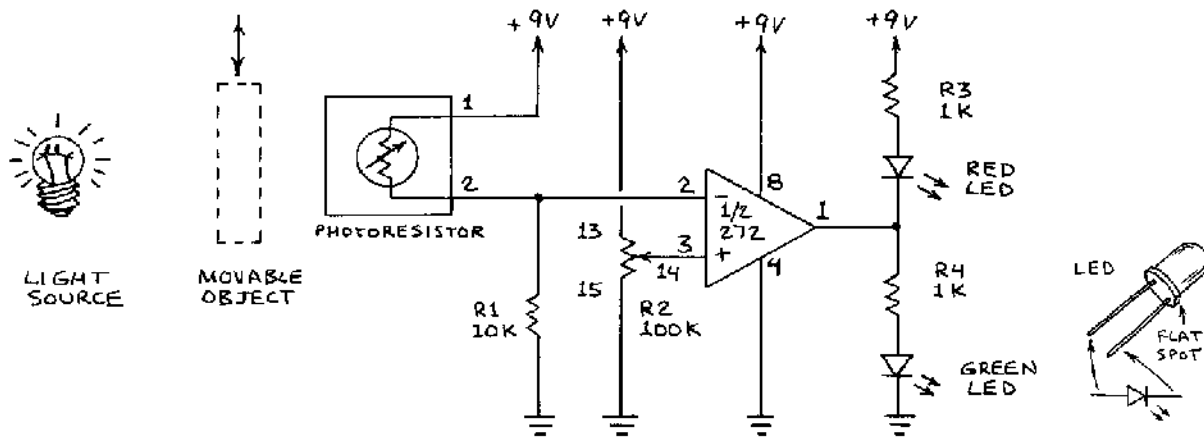

1. BUILD THE CIRCUIT

1. PUSH POWER AND DISPLAY SWITCHES OFF.
2. INSERT PHOTORESISTOR CARD IN SENSOR SOCKET.
3. INSERT 272 IC ACROSS SLOT (PIN 1 AT J5).
4. INSERT R1 ACROSS K1 AND GROUND.
5. INSERT R3 ACROSS I1 AND +9V.
6. INSERT R4 ACROSS J3 AND T3.
7. INSERT RED LED ACROSS I2 (ANODE) AND J2 (CATHODE).
8. INSERT GREEN LED ACROSS T2 (ANODE) AND GROUND (CATHODE).
9. CONNECT M4 TO GROUND (WHT).
10. CONNECT J10 TO +9V (WHT).
11. CONNECT SPRING 1 TO +9V (WHT).
12. CONNECT SPRING 2 TO K4 (RED).
13. CONNECT SPRING 13 TO J9 (BLU).
14. CONNECT SPRING 14 TO L4 (BLU).
15. CONNECT SPRING 15 TO GROUND (RED).

2. TEST THE CIRCUIT

INSPECT YOUR WIRING FOR ERRORS. PUSH THE POWER SWITCH TO ON. PLACE A FINGER OVER THE LIGHT SENSITIVE PART OF THE PHOTORESISTOR CARD. ROTATE THE 100K CONSOLE POT (R2) UNTIL THE GREEN LED GLOWS. MOVE YOUR FINGER, AND THE RED LED GLOWS. EXPERIMENT WITH THE ADJUSTMENT OF R2 AND THE AMOUNT OF LIGHT AT THE CONSOLE.

3. GOING FURTHER

TRY THIS CIRCUIT WITH THE EXTENSION CABLE. PUSH THE POWER SWITCH OFF AND INSERT THE PHOTORESISTOR CARD IN THE CABLE SOCKET. INSERT THE CABLE PLUG IN THE CONSOLE SENSOR SOCKET. ARRANGE THE POSITION OF THE PHOTORESISTOR CARD FOR EXPERIMENTS. FOR EXAMPLE, PLACE THE CARD FLAT ON A TABLE WITH THE LIGHT-SENSITIVE SIDE UP, AND ADJUST R2 TO TRIGGER THE RED LED WHEN AN OBJECT IS REMOVED FROM THE CARD.

BUILD A BASIC PHOTORESISTOR LIGHT METER

YOU CAN BUILD A SIMPLE BUT USEFUL LIGHT METER USING ONLY THE PHOTORESISTOR CARD, A SINGLE POTENTIOMETER, AND THE LED READOUT. YOU WILL LEARN HOW TO ADJUST THE SENSITIVITY OF THE LIGHT METER.

PARTS YOU WILL NEED

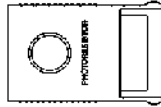

IF THE LED READOUT DOES NOT SEEM TO RESPOND TO THIS AND OTHER LIGHT SENSITIVE CIRCUITS, TOO MUCH LIGHT MAY BE STRIKING THE LIGHT SENSOR. COVER THE SENSOR OR PLACE THE CONSOLE IN A DARKENED AREA.

CIRCUIT DIAGRAM

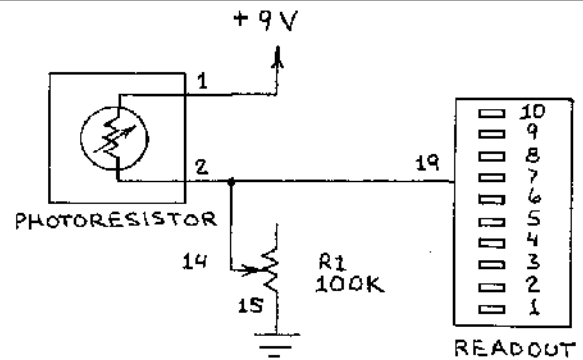

1. BUILD THE CIRCUIT

- PUSH POWER AND DISPLAY SWITCHES OFF.
- INSERT PHOTORESISTOR CARD IN SENSOR SOCKET.
- CONNECT SPRING 1 TO +9V (WHT).
- CONNECT SPRINGS 2 AND 19 (BLU).
- CONNECT SPRINGS 14 AND 19 (RED).
- CONNECT SPRING 15 TO GROUND (RED).

2. TEST THE CIRCUIT

BE SURE YOUR WIRING IS CORRECT. ROTATE THE 100K CONSOLE POTENTIOMETER (R1) ALL THE WAY TO THE LEFT. PLACE YOUR HAND OVER THE PHOTORESISTOR CARD TO SHADE IT FROM ROOM LIGHT. NOW PUSH THE POWER SWITCH TO ON AND THE DISPLAY SWITCH TO DOT MODE. THE LED READOUT SHOULD BE DARK OR THE NUMBER 1 LED MAY GLOW. VERY SLOWLY EXPOSE THE PHOTORESISTOR TO LIGHT WHILE ROTATING R1 TO THE RIGHT. HIGHER VALUE LEDS NOW GLOW. DARKEN THE PHOTORESISTOR TO RETURN THE BARGRAPH TO A LOWER POSITION. THE LIGHT METER IS MOST SENSITIVE WHEN R1 IS ROTATED ALL THE WAY TO THE RIGHT.

3. GOING FURTHER

THE EXTENSION CABLE CONVERTS THE PHOTORESISTOR CARD INTO A MOVABLE LIGHT PROBE. PUSH THE POWER SWITCH TO OFF. INSERT THE PHOTORESISTOR CARD INTO THE CABLE SOCKET. PLUG THE CABLE INTO THE CONSOLE SENSOR SOCKET. PUSH THE POWER SWITCH TO ON. POINT THE PHOTORESISTOR IN VARIOUS DIRECTIONS AND TOWARD DIFFERENT LIGHT SOURCES WHILE WATCHING THE READOUT BOUNCE UP AND DOWN. FOR A REALLY NEAT EXPERIMENT, DIM THE ROOM LIGHTS AND ADJUST R1 UNTIL LED 1 GLOWS. IT MAY BE NECESSARY TO PRIME THE CIRCUIT BY ALLOWING SOME ROOM LIGHT TO REACH THE PHOTORESISTOR. POINT THE PHOTORESISTOR CARD AT LED 1. IF YOU MOVE THE SENSOR CARD TOWARD LED 10, A GLOWING LED WILL FOLLOW THE CARD. MOVE THE SENSOR CARD BACK TO LED 1, AND A GLOWING LED FOLLOWS.

INVENTION BOX

WHAT USES CAN YOU THINK OF FOR A ROW OF LEDS THAT TRACKS THE POSITION OF A LIGHT SENSOR? CAN THIS METHOD BE USED TO MOVE A SPOT OF LIGHT ON A COMPUTER SCREEN? (YES.)

BUILD AN ULTRA-SENSITIVE LIGHT METER

THE SUPPLIED PHOTORESISTOR SENSOR CARD CAN BE MADE MUCH MORE SENSITIVE BY ADDING AN AMPLIFIER. CONNECT THE PHOTORESISTOR TO ONE OF THE AMPLIFIERS IN THE 272 OPERATIONAL AMPLIFIER TO INCREASE ITS SENSITIVITY.

PARTS YOU WILL NEED

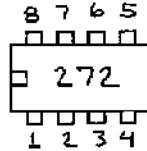
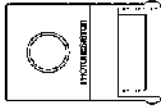

R1-10K (BRN-BLK-ORG)
R2-1K (BRN-BLK-RED)

CIRCUIT DIAGRAM

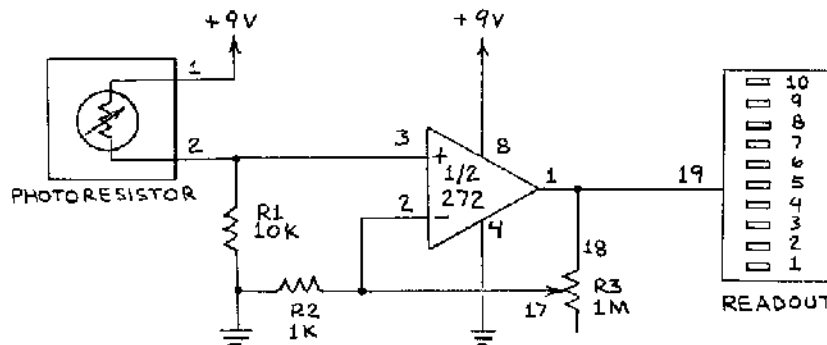

1. BUILD THE CIRCUIT

1. PUSH POWER AND DISPLAY SWITCHES OFF.
2. INSERT PHOTORESISTOR CARD IN SENSOR SOCKET.
3. INSERT 272 IC ACROSS SLOT (PIN 1 AT J5).
4. INSERT R1 ACROSS L3 AND M3.
5. INSERT R2 ACROSS K1 AND M2.
6. CONNECT M1 TO GROUND (WHT).
7. CONNECT J10 TO +9V (WHT).
8. CONNECT SPRING 1 TO +9V (WHT).
9. CONNECT SPRING 2 TO L4 (RED).
10. CONNECT SPRING 17 TO K4 (BLU).
11. CONNECT SPRING 18 TO J4 (BLU).
12. CONNECT SPRING 19 TO J1 (RED).

2. TEST THE CIRCUIT

CHECK YOUR WIRING FOR POSSIBLE ERRORS. THEN DIM THE ROOM LIGHTS OR PLACE THE CONSOLE IN A SHADED AREA. ROTATE THE 1M CONSOLE POTENTIOMETER (R3) ALL THE WAY TO THE LEFT. PUSH THE POWER SWITCH TO ON AND PUSH THE DISPLAY SWITCH TO DOT MODE. IF THE PHOTORESISTOR IS DARK, NONE OR ONE OF THE LOWEST LEDS GLOWS. SLOWLY EXPOSE THE PHOTORESISTOR TO LIGHT. HIGHER VALUE LEDS NOW GLOW. DARKEN THE PHOTORESISTOR TO RETURN THE BARGRAPH TO A LOWER POSITION. FOR MAXIMUM SENSITIVITY, ROTATE R3 ALL THE WAY TO THE RIGHT.

3. GOING FURTHER

IT MAY BE EASIER TO DARKEN THE PHOTORESISTOR USING THE EXTENSION CABLE TO CONNECT THE SENSOR CARD TO THE CONSOLE SOCKET. YOU CAN THEN PLACE THE PHOTORESISTOR SENSOR CARD FACE DOWN ON A FLAT SURFACE AND COVER IT WITH DARK CLOTH OR PAPER. THIS ALLOWS YOU TO TEST THE CIRCUIT WITH THE ROOM LIGHTS ON.

BUILD AN OPTICAL FEEDBACK CIRCUIT

YOU WILL BUILD AN OPTICAL FEEDBACK CIRCUIT THAT SENSES THE PRESENCE OF AN OBJECT.

PARTS YOU WILL NEED

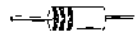
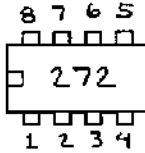
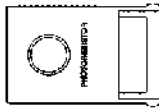

R2-10K (BRN-BLK-ORG)
R3-1K (BRN-BLK-RED)



LED 1-GREEN LED

CIRCUIT DIAGRAM

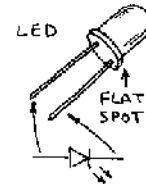
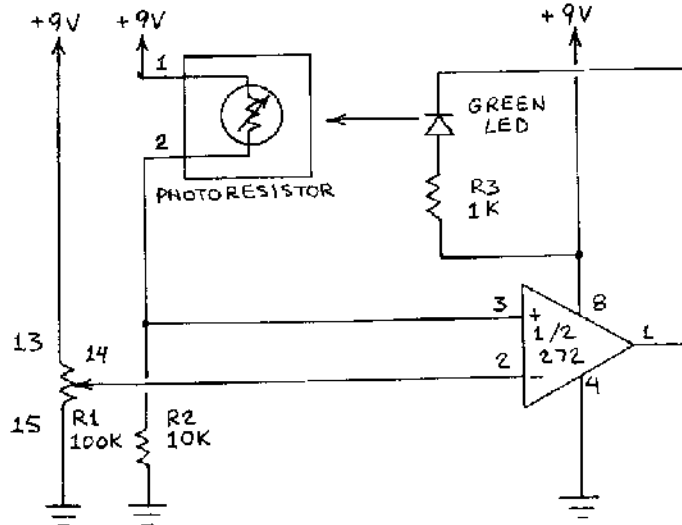

1. BUILD THE CIRCUIT

- PUSH POWER AND DISPLAY SWITCHES OFF.
- INSERT PHOTORESISTOR CARD IN SENSOR SOCKET.
- INSERT 272 IC ACROSS SLOT (PIN 1 AT J5).
- INSERT R2 ACROSS L2 AND GROUND.
- INSERT R3 ACROSS I5 AND -9V.
- INSERT GREEN LED ACROSS I1 (ANODE) AND J4 (CATHODE).
- BEND LED TO PHOTORESISTOR CARD.
- CONNECT M4 TO GROUND (WHT).
- CONNECT J10 TO +9V (WHT).
- CONNECT SPRING 1 TO +9V (WHT).
- CONNECT SPRING 2 TO L4 (RED).
- CONNECT SPRING 13 TO +9V (BLU).
- CONNECT SPRING 14 TO K2 (BLU).
- CONNECT SPRING 15 TO GROUND (RED).

2. TEST THE CIRCUIT

BE SURE YOUR WIRING IS CORRECT AND THAT THE LED POINTS TO THE PHOTORESISTOR CARD. DIM THE LIGHTS AND ROTATE THE 100K CONSOLE POT (R1) ALL THE WAY TO THE LEFT. PUSH THE POWER SWITCH TO ON AND ROTATE R1 TO THE RIGHT UNTIL THE LED JUST GLOWS. PLACE A PENCIL OR FINGER BETWEEN THE LED AND THE PHOTORESISTOR. THE LED BRIGHTENS. REMOVE THE OBJECT AND THE LED DIMS AGAIN. FOR MORE DRAMATIC RESULTS, ADJUST R1 UNTIL THE LED IS FAIRLY BRIGHT AND REPEAT THE EXPERIMENT.

3. GOING FURTHER

THIS CIRCUIT OSCILLATES, PRODUCING AROUND 120,000 PULSES PER SECOND. WHEN LIGHT STRIKES THE PHOTORESISTOR, THE AMPLIFIER SENDS LESS CURRENT TO THE LED. THIS CAUSES THE AMPLIFIER TO SEND MORE CURRENT TO THE LED.

BUILD A LIGHT-ACTIVATED BUZZER

BUILD A CIRCUIT THAT TRIGGERS THE BUZZER WHEN LIGHT STRIKES THE PHOTOTRANSISTOR.

PARTS YOU WILL NEED

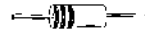
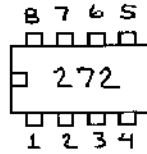
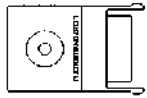

R1 10K (BRN BLK ORG)
R3-1K (BRN-BLK-RED)



Q1-POWER FET

CIRCUIT DIAGRAM

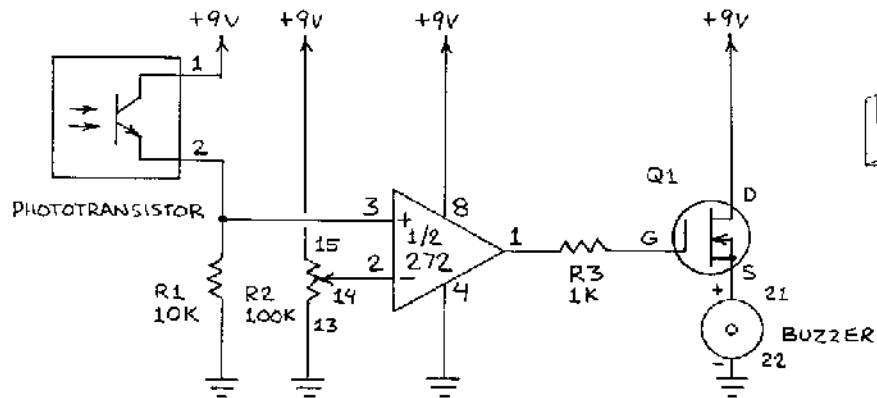

1. BUILD THE CIRCUIT

1. PUSH POWER AND DISPLAY SWITCHES OFF.
2. INSERT PHOTOTRANSISTOR CARD IN SENSOR SOCKET.
3. INSERT 272 IC ACROSS SLOT (PIN 1 AT J5).
4. INSERT Q1 AT C1 (G), B1 (D) AND A1 (S).
5. INSERT R1 ACROSS L3 AND GROUND.
6. INSERT R3 ACROSS C3 AND J3.
7. CONNECT M1 TO GROUND (WHT).
8. CONNECT J10 TO +9V (WHT).
9. CONNECT B4 TO +9V (WHT).
10. CONNECT SPRING 1 TO +9V (WHT).
11. CONNECT SPRING 2 TO L4 (RED).
12. CONNECT SPRING 21 TO A5 (RED).
13. CONNECT SPRING 22 TO GROUND (BLU).
14. CONNECT SPRING 13 TO GROUND (RED).
15. CONNECT SPRING 14 TO K1 (BLU).
16. CONNECT SPRING 15 TO +9V (BLU).

2. TEST THE CIRCUIT

CHECK YOUR WIRING FOR ERRORS. PUSH THE POWER SWITCH TO ON. SHIELD THE PHOTOTRANSISTOR FROM DIRECT LIGHT. ROTATE THE 100K CONSOLE POT (R2) UNTIL THE BUZZER JUST BECOMES SILENT. REMOVE YOUR HAND, AND THE BUZZER SOUNDS.

BUILD A DARK-ACTIVATED BUZZER

YOU WILL CONVERT THE LIGHT-ACTIVATED BUZZER ABOVE TO A DARK-ACTIVATED BUZZER.

1. BUILD THE CIRCUIT

1. PUSH THE POWER SWITCH TO OFF.
2. MOVE THE BLU WIRE AT K1 TO L1.
3. MOVE THE RED WIRE AT L4 TO K4.
4. MOVE R1 FROM L3 TO K3.

2. TEST THE CIRCUIT

PUSH THE POWER SWITCH TO ON. SHIELD THE PHOTOTRANSISTOR FROM LIGHT AND THE BUZZER SOUNDS. ADJUST THE 100K CONSOLE POT (R2) TO ADJUST THE SENSITIVITY.

BUILD A LIGHT-ACTIVATED TONE

YOU WILL BUILD A CIRCUIT THAT EMITS A TONE WHEN STRUCK BY LIGHT.

PARTS YOU WILL NEED

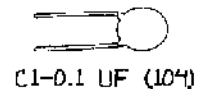
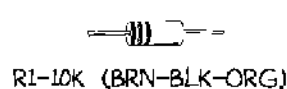
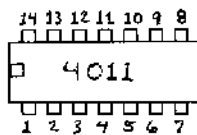
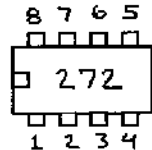
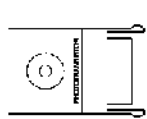

CIRCUIT DIAGRAM

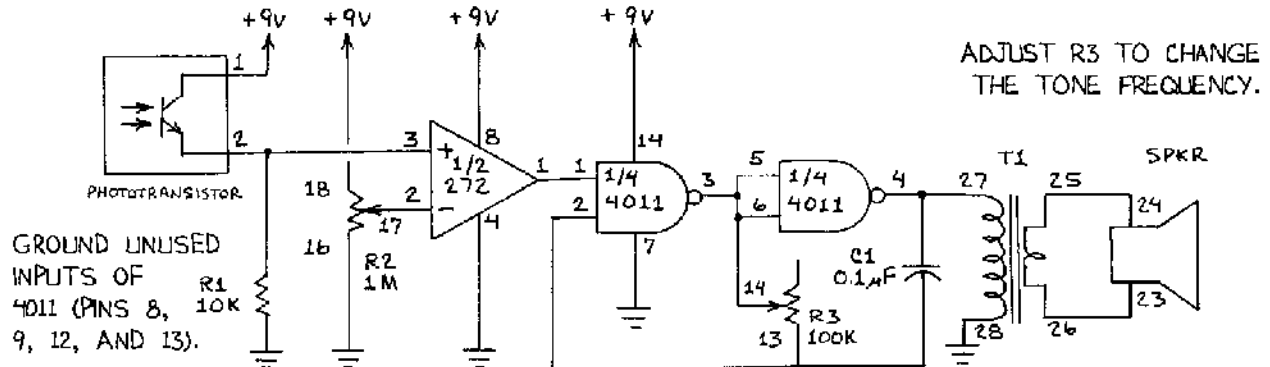

1. BUILD THE CIRCUIT

1. PUSH POWER AND DISPLAY SWITCHES OFF.
2. INSERT PHOTOTRANSISTOR CARD IN SENSOR SOCKET.
3. INSERT 272 IC ACROSS SLOT (PIN 1 AT E5).
4. INSERT 4011 IC ACROSS SLOT (PIN 1 AT N5).
5. INSERT R1 ACROSS G3 AND H3.
6. INSERT C1 ACROSS O1 AND Q1.
7. CONNECT H1 TO GROUND (RED).
8. CONNECT E10 TO +9V (WHT).
9. CONNECT T4 TO GROUND (WHT).
10. CONNECT N9 TO +9V (RED).
11. CONNECT E4 TO N4 (WHT).
12. CONNECT P3 TO R3 (WHT).
13. CONNECT R2 TO S2 (WHT).
14. CONNECT O10 TO P10 (WHT).
15. CONNECT P9 TO S9 (WHT).
16. CONNECT S10 TO T10 (WHT).
17. CONNECT T9 TO GROUND (WHT).
18. CONNECT SPRING 1 TO +9V (WHT).
19. CONNECT SPRING 2 TO G4 (RED).
20. CONNECT SPRINGS 24 AND 25 (WHT).
21. CONNECT SPRINGS 23 AND 26 (RED).
22. CONNECT SPRING 27 TO Q4 (RED).
23. CONNECT SPRING 28 TO GROUND (RED).
24. CONNECT SPRING 13 TO O4 (RED).
25. CONNECT SPRING 14 TO P4 (BLU).
26. CONNECT SPRING 16 TO GROUND (BLU).
27. CONNECT SPRING 17 TO F1 (BLU).
28. CONNECT SPRING 18 TO +9V (BLU).

2. TEST THE CIRCUIT

CHECK FOR ERRORS. PUSH THE POWER SWITCH ON. SHADE THE SENSOR WITH YOUR HAND. ROTATE 1M POT (R2) UNTIL TONE IS JUST OFF. MOVE YOUR HAND. THE TONE SOUNDS.

BUILD A DARK-ACTIVATED TONE

YOU WILL MODIFY THE CIRCUIT ABOVE TO EMIT A TONE WHEN DARK.

1. BUILD THE CIRCUIT

1. PUSH THE POWER SWITCH TO OFF.
2. MOVE THE BLU WIRE AT F1 TO G1.
3. MOVE THE RED WIRE AT G4 TO F4.
4. MOVE R1 FROM G3 TO F3.

2. TEST THE CIRCUIT

PUSH THE POWER SWITCH ON. SHIELD THE PHOTOTRANSISTOR AND THE TONE SOUNDS. ADJUST THE 1M CONSOLE POT (R2) TO INCREASE THE SENSITIVITY.

BUILD A BASIC PHOTOTRANSISTOR LIGHT METER

YOU WILL BUILD A SIMPLE LIGHT METER USING THE PHOTOTRANSISTOR CARD, A SINGLE POTENTIOMETER, AND LED READOUT. YOU WILL LEARN TO ADJUST THE LIGHT METER SENSITIVITY.

PARTS YOU WILL NEED | CIRCUIT DIAGRAM

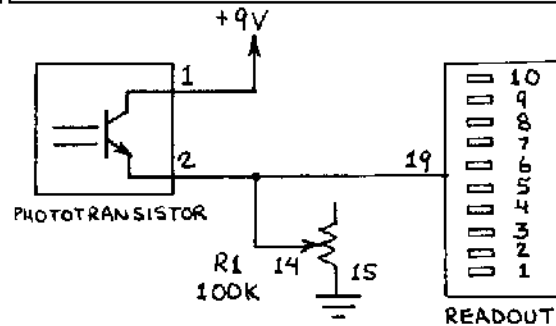
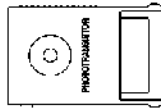

1. BUILD THE CIRCUIT

1. PUSH POWER AND DISPLAY SWITCHES OFF.
2. INSERT PHOTOTRANSISTOR CARD IN SENSOR SOCKET.
3. CONNECT SPRING 1 TO +9V (WHT).
4. CONNECT SPRINGS 2 AND 19 (BLU).
5. CONNECT SPRINGS 14 AND 19 (RED).
6. CONNECT SPRING 15 TO GROUND (RED).

2. TEST THE CIRCUIT

CHECK YOUR WIRING FOR ERRORS. ROTATE THE 100K CONSOLE POT (R1) ALL THE WAY TO THE LEFT. SHADE THE PHOTOTRANSISTOR CARD TO BLOCK LIGHT. THEN PUSH THE POWER SWITCH ON AND THE DISPLAY SWITCH TO DOT MODE. THE LED READOUT IS DARK. SLOWLY EXPOSE THE PHOTOTRANSISTOR TO LIGHT WHILE ROTATING R1 TO THE RIGHT. HIGHER VALUE LEDS NOW GLOW. DARKEN THE PHOTOTRANSISTOR TO RETURN THE BARGRAPH TO A LOWER POSITION. ROTATE R1 ALL THE WAY TO THE RIGHT FOR THE HIGHEST SENSITIVITY.

3. GOING FURTHER

USE THE EXTENSION CABLE TO CONVERT THE PHOTOTRANSISTOR CARD INTO A MOVABLE LIGHT PROBE. PUSH THE POWER SWITCH OFF AND INSERT THE PHOTOTRANSISTOR CARD INTO THE CABLE SOCKET. PLUG THE CABLE INTO THE CONSOLE SENSOR SOCKET. NOW PUSH THE POWER SWITCH ON, AND POINT THE PHOTOTRANSISTOR IN DIFFERENT DIRECTIONS WHILE WATCHING THE READOUT BOUNCE UP AND DOWN.

THE BASIC PHOTORESISTOR LIGHT METER PROJECT ON PAGE 85 DESCRIBES HOW TO MAKE THE LEDS IN THE READOUT FOLLOW THE POSITION OF THE PHOTORESISTOR. TRY THIS WITH THE PHOTOTRANSISTOR CARD. FIRST, DIM THE ROOM LIGHTS AND ADJUST R1 UNTIL LED 1 GLOWS. POINT THE PHOTOTRANSISTOR CARD AT LED 1. MOVE THE SENSOR CARD TOWARD LED 10, AND A GLOWING LED FOLLOWS THE CARD. MOVE THE SENSOR CARD BACK TO LED 1, AND A GLOWING LED FOLLOWS.

INVENTION BOX

THIS CIRCUIT AND THE ONE ON PAGE 85 ARE SIMILAR TO CIRCUITS THAT ALLOW A LIGHT PEN TO MOVE A DOT ON A COMPUTER SCREEN. WHICH SENSOR IS BEST FOR THIS APPLICATION, THE PHOTORESISTOR OR THE PHOTOTRANSISTOR? (THE PHOTOTRANSISTOR IS BEST BECAUSE IT RESPONDS FASTER.)

BUILD A SUPER-SENSITIVE RADIOMETER

THE SENSITIVITY OF THE PHOTOTRANSISTOR SENSOR CARD CAN BE GREATLY INCREASED WITH THE HELP OF AN AMPLIFIER. YOU WILL INCREASE THE SENSITIVITY OF THE PHOTOTRANSISTOR BY CONNECTING IT TO THE 272 OPERATIONAL AMPLIFIER.

PARTS YOU WILL NEED

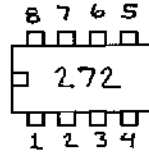
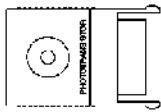

R1-10K (BRN-BLK-ORG)
R2-1K (BRN-BLK-RED)

CIRCUIT

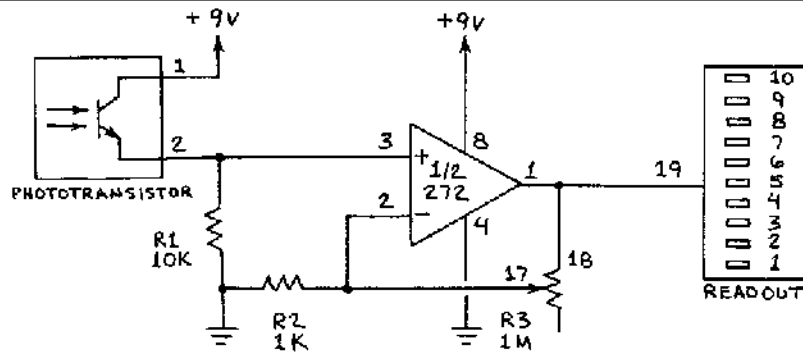

1. BUILD THE CIRCUIT

1. PUSH POWER AND DISPLAY SWITCHES OFF.
2. INSERT PHOTOTRANSISTOR CARD IN SENSOR SOCKET.
3. INSERT 272 IC ACROSS SLOT (PIN 1 AT J5).
4. INSERT R1 ACROSS I3 AND M3.
5. INSERT R2 ACROSS K1 AND M2.
6. CONNECT M1 TO GROUND (WHT).
7. CONNECT J10 TO +9V (WHT).
8. CONNECT SPRING 1 TO +9V (WHT).
9. CONNECT SPRING 2 TO L4 (RED).
10. CONNECT SPRING 17 TO K4 (BLU).
11. CONNECT SPRING 18 TO J4 (BLU).
12. CONNECT SPRING 19 TO J1 (RED).

2. TEST THE CIRCUIT

TO MAKE SURE THERE ARE NO ERRORS, PLACE THE CONSOLE IN A DARKENED OR SHADED AREA. NEXT, ROTATE THE 1M CONSOLE POTENTIOMETER (R3) ALL THE WAY TO THE LEFT. PUSH THE POWER SWITCH ON AND PUSH THE DISPLAY SWITCH TO DOT MODE. WHEN THE PHOTOTRANSISTOR IS DARK, NONE OR ONE OF THE LOWEST LEDS GLOWS. AS YOU VERY SLOWLY EXPOSE THE PHOTOTRANSISTOR TO LIGHT, HIGHER VALUE LEDS GLOW. DARKEN THE PHOTOTRANSISTOR TO RETURN THE BARGRAPH TO A LOWER POSITION. FOR HIGHEST SENSITIVITY, ROTATE R3 ALL THE WAY TO THE RIGHT. TOO SENSITIVE? CHANGE R3 TO THE 10K POT.

3. GOING FURTHER

AS WITH THE PHOTORESISTOR VERSION OF THIS CIRCUIT ON PAGE 86, IT MAY BE EASIER TO DARKEN THE PHOTOTRANSISTOR IF YOU CONNECT THE PHOTOTRANSISTOR CARD TO THE CONSOLE SOCKET WITH THE EXTENSION CABLE. PLACE THE PHOTOTRANSISTOR SENSOR CARD FACE DOWN ON A FLAT SURFACE AND COVER IT WITH DARK CLOTH OR PAPER. YOU CAN NOW TEST THE CIRCUIT WITH THE ROOM LIGHTS ON.

BUILD A LIGHT-CONTROLLED OSCILLATOR

YOU WILL BUILD AN AUDIO OSCILLATOR WHOSE TONE CHANGES WITH LIGHT. BRIGHTER LIGHT WILL EITHER DECREASE OR INCREASE THE TONE FREQUENCY.

PARTS YOU WILL NEED

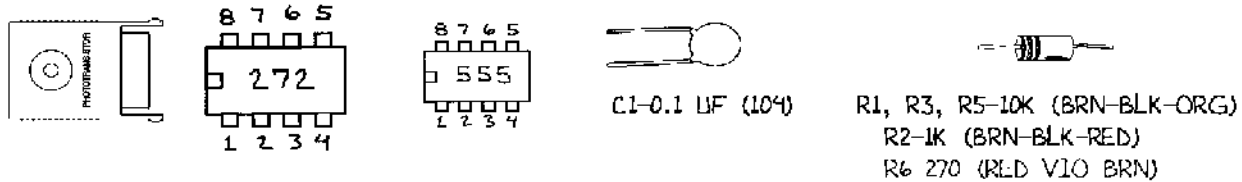

CIRCUIT DIAGRAM

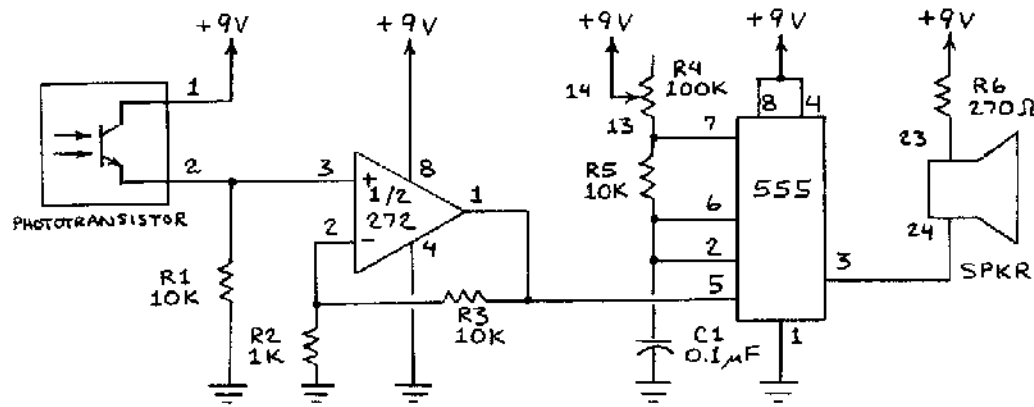

1. BUILD THE CIRCUIT

- | | |
|---|---|
| <ol style="list-style-type: none"> 1. <input type="checkbox"/> PUSH POWER AND DISPLAY SWITCHES OFF. 2. <input type="checkbox"/> INSERT PHOTOTRANSISTOR CARD IN SENSOR SOCKET. 3. <input type="checkbox"/> INSERT 272 IC ACROSS SLOT (PIN 1 AT J5). 4. <input type="checkbox"/> INSERT 555 IC ACROSS SLOT (PIN 1 AT Q5). 5. <input type="checkbox"/> INSERT R1 ACROSS L3 AND M3. 6. <input type="checkbox"/> INSERT R2 ACROSS K1 AND M2. 7. <input type="checkbox"/> INSERT R3 ACROSS J2 AND K2. 8. <input type="checkbox"/> INSERT R5 ACROSS R10 AND S10. 9. <input type="checkbox"/> INSERT R6 ACROSS C6 AND +9V. 10. <input type="checkbox"/> INSERT C1 ACROSS R1 AND GROUND. 11. <input type="checkbox"/> CONNECT M1 TO GROUND (WHT). | <ol style="list-style-type: none"> 12. <input type="checkbox"/> CONNECT J10 TO -9V (WHT). 13. <input type="checkbox"/> CONNECT J9 TO Q9 (WHT). 14. <input type="checkbox"/> CONNECT J4 TO T7 (WHT). 15. <input type="checkbox"/> CONNECT Q7 TO T4 (WHT). 16. <input type="checkbox"/> CONNECT R4 TO S7 (WHT). 17. <input type="checkbox"/> CONNECT Q1 TO GROUND (WHT). 18. <input type="checkbox"/> CONNECT SPRING 1 TO +9V (WHT). 19. <input type="checkbox"/> CONNECT SPRING 2 TO L4 (RED). 20. <input type="checkbox"/> CONNECT SPRING 23 TO C10 (RED). 21. <input type="checkbox"/> CONNECT SPRING 24 TO S4 (RED). 22. <input type="checkbox"/> CONNECT SPRING 13 TO R9 (BLU). 23. <input type="checkbox"/> CONNECT SPRING 14 TO +9V (BLU). |
|---|---|

2. TEST THE CIRCUIT

CHECK FOR WIRING ERRORS. PUSH THE POWER SWITCH ON. ROTATE CONSOLE POTENTIOMETER R4 TO THE RIGHT, AND YOU HEAR A BUZZ. SHIELD THE PHOTOTRANSISTOR CARD FROM LIGHT. THE FREQUENCY OF THE BUZZ DECREASES. ROTATE R4 TO THE RIGHT TO INCREASE THE TONE FREQUENCY.

3. GOING FURTHER

YOU CAN INCREASE THE TONE FREQUENCY BY CHANGING C1 TO 0.01 uF (103). CONNECT THE PHOTOTRANSISTOR CARD TO THE REMOTE LINK AND YOU CAN POINT THE PHOTOTRANSISTOR AT VARIOUS LIGHT SOURCES.

BUILD A PHOTOTRANSISTOR FEEDBACK CIRCUIT

PAGE 87 SHOWS HOW TO BUILD AN OPTICAL FEEDBACK CIRCUIT USING THE PHOTORESISTOR CARD AND A GREEN LED. HERE YOU WILL BUILD A SIMILAR CIRCUIT THAT USES THE PHOTOTRANSISTOR CARD AND A RED LED. YOU WILL LEARN WHY THE PHOTOTRANSISTOR RESPONDS BETTER TO RED LIGHT THAN TO GREEN.

PARTS YOU WILL NEED

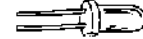
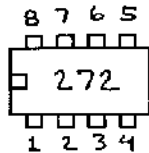
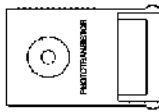

R1-10K (BRN-BLK-ORG)

1 RED LED

R3-1M (BRN-BLK-GRN)

R4-470 (YEL-VIO-BRN)

CIRCUIT DIAGRAM

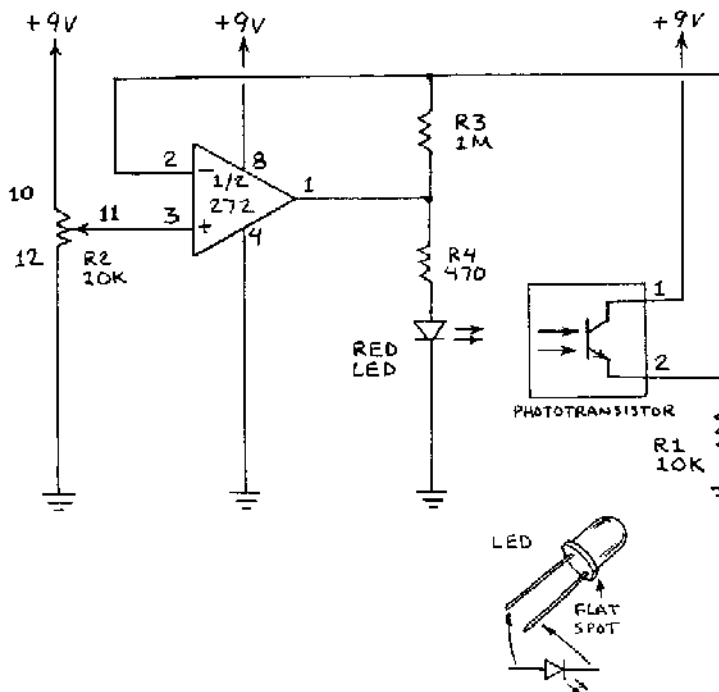

1. BUILD THE CIRCUIT

1. PUSH POWER AND DISPLAY SWITCHES OFF.
2. INSERT PHOTOTRANSISTOR CARD IN SENSOR SOCKET.
3. INSERT 272 IC ACROSS SLOT (PIN 1 AT J5).
4. INSERT R1 ACROSS K2 AND M2.
5. INSERT R3 ACROSS J3 AND K3.
6. INSERT R4 ACROSS I1 AND J1.
7. INSERT RED LED ACROSS I5 (ANODE) AND I6 (CATHODE).
8. BEND THE LED TOWARD THE PHOTOTRANSISTOR CARD.
9. CONNECT M4 TO I7 (WHT).
10. CONNECT M1 TO GROUND (WHT).
11. CONNECT J10 TO +9V (WHT).
12. CONNECT SPRING 1 TO +9V (WHT).
13. CONNECT SPRING 2 TO K4 (RED).
14. CONNECT SPRING 10 TO +9V (BLU).
15. CONNECT SPRING 11 TO I1 (RED).
16. CONNECT SPRING 12 TO GROUND (RED).

2. TEST THE CIRCUIT

CHECK FOR ERRORS. MAKE SURE THE LED IS POINTING TO THE PHOTOTRANSISTOR CARD. DIM THE LIGHTS AND PLACE THE CONSOLE WHERE THE PHOTOTRANSISTOR IS NEARLY DARK. ROTATE THE 10K CONSOLE POT (R2) TO THE LEFT. PUSH THE POWER SWITCH ON. ROTATE R2 TOWARD THE RIGHT UNTIL THE LED GLOWS. PLACE A PENCIL OR FINGER TIP BETWEEN THE LED AND PHOTOTRANSISTOR. THE LED BRIGHTENS. REMOVE THE OBJECT AND THE LED IS AS DIM AS BEFORE. AS WITH THE CIRCUIT ON PAGE 87, YOU CAN ADJUST THE CIRCUIT FOR MORE DRAMATIC RESULTS. ROTATE R2 UNTIL THE LED IS FAIRLY BRIGHT. REPEAT THE EXPERIMENT.

3. GOING FURTHER

THE PHOTOTRANSISTOR RESPONDS TO BOTH RED AND GREEN LIGHT, BUT IT RESPONDS TO RED BETTER THAN TO GREEN. TO PROVE THE PHOTOTRANSISTOR RESPONDS TO GREEN LIGHT, REPLACE THE RED LED WITH A GREEN LED. INSTALL THE GREEN LED IN THE SAME DIRECTION (ANODE AT I5 AND CATHODE AT I6). REPEAT THE TESTS DONE ABOVE.

BUILD A LIGHT BEAM AUDIO RECEIVER

BUILD A SENSITIVE LIGHT BEAM RECEIVER THAT CONVERTS INFRARED SIGNALS FROM A TV REMOTE CONTROL UNIT INTO SOUND. LEAVE THIS CIRCUIT IN PLACE TO BUILD THE CIRCUIT ON PAGE 95.

PARTS YOU WILL NEED

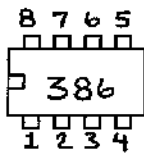
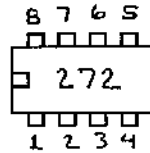
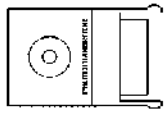

C1-0.1 UF (104)
C2-470 UF

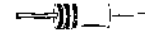

R1-10K (BRN-BLK-ORG)
R3-1M (BRN-BLK-GRN)

CIRCUIT DIAGRAM

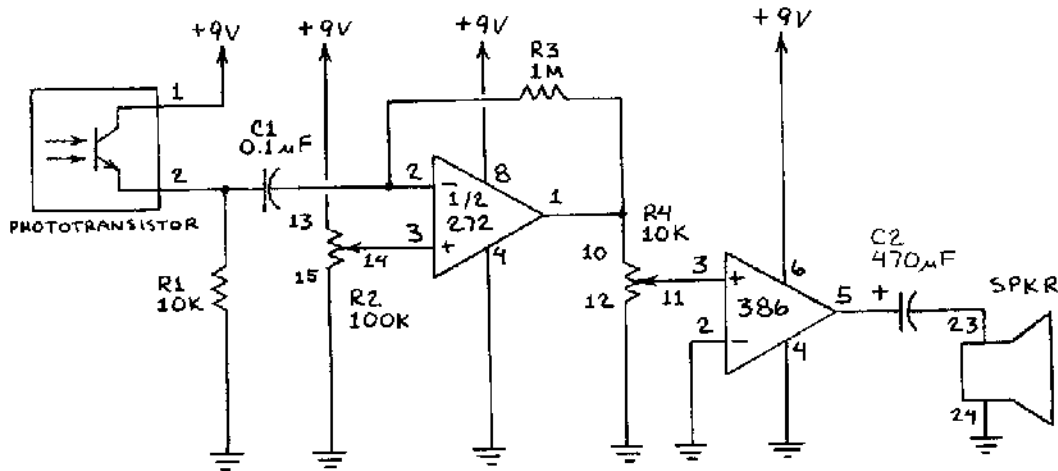

1. BUILD THE CIRCUIT

1. PUSH POWER AND DISPLAY SWITCHES OFF.
2. INSERT PHOTOTRANSISTOR CARD IN SENSOR SOCKET.
3. INSERT 272 IC ACROSS SLOT (PIN 1 AT J5).
4. INSERT 386 IC ACROSS SLOT (PIN 1 AT A5).
5. INSERT R1 ACROSS H4 AND M4.
6. INSERT R3 ACROSS J3 AND K3.
7. INSERT C1 ACROSS H1 AND K1.
8. INSERT C2 ACROSS D7 (+) AND F7 (-).
9. CONNECT M1 TO GROUND (WHT).
10. CONNECT J10 TO +9V (WHT).
11. CONNECT B2 TO D2 (WHT).
12. CONNECT D1 TO GROUND (RED).
13. CONNECT C10 TO +9V (WHT).
14. CONNECT SPRING 1 TO +9V (WHT).
15. CONNECT SPRING 2 TO H5 (RED).
16. CONNECT SPRING 10 TO J1 (RED).
17. CONNECT SPRING 11 TO C1 (BLU).
18. CONNECT SPRING 12 TO GROUND (RED).
19. CONNECT SPRING 13 TO -9V (BLU).
20. CONNECT SPRING 14 TO L1 (BLU).
21. CONNECT SPRING 15 TO GROUND (RED).
22. CONNECT SPRING 23 TO F10 (RED).
23. CONNECT SPRING 24 TO GROUND (RED).

2. TEST THE CIRCUIT

THIS CIRCUIT IS VERY SENSITIVE. IF YOU HEAR A LOUD BUZZ, IT IS PROBABLY DETECTING THE ROOM LIGHTS, WHICH ARE MODULATED AT 60 HERTZ BY THE POWER LINE. STOP THE BUZZ BY POINTING THE PHOTOTRANSISTOR AWAY FROM THE LIGHT OR BY SWITCHING THE LIGHT OFF. IF THE SPEAKER SQUEALS LOUDLY, MOVE THE RED WIRE AWAY AT SPRING 2 FROM THE 386 AMPLIFIER. ADJUST 10K CONSOLE POT R4 TO CONTROL THE VOLUME. ADJUST 100K CONSOLE POT R2 FOR BEST SOUND.

BUILD AN LED TRANSMITTER FOR THE LIGHT RECEIVER

YOU WILL BUILD A SIMPLE LED TRANSMITTER THAT SENDS A RAPID STREAM OF PULSES TO THE LIGHT RECEIVER ON PAGE 94. BE SURE TO LEAVE THE CIRCUIT ON PAGE 94 IN PLACE. YOU WILL BUILD THIS CIRCUIT ON THE UNUSED SPACE AT THE BOTTOM OF THE BREADBOARD.

PARTS YOU WILL NEED

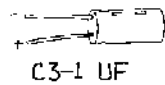
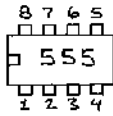

R6-10K (BRN-BLK-ORG)
R7-470 (YEL-VIO-BRN)

1 RED LED

CIRCUIT DIAGRAM

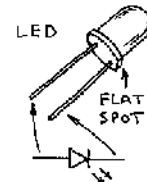
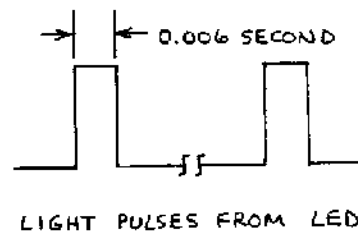
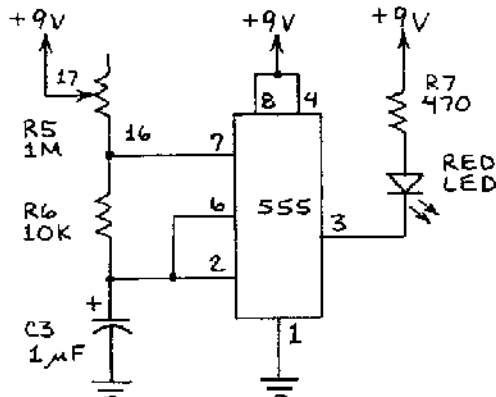

1. BUILD THE CIRCUIT

1. PUSH POWER AND DISPLAY SWITCHES OFF.
2. INSERT 555 IC ACROSS SLOT (PIN 1 AT Q5).
3. INSERT R6 ACROSS R10 AND S10.
4. INSERT R7 ACROSS P5 AND Q8.
5. INSERT C3 ACROSS S9 (+) AND GROUND (-).
6. INSERT LED ACROSS P1 (ANODE) AND S1 (CATHODE).
7. CONNECT Q1 TO GROUND (WHT).
8. CONNECT Q10 TO J9 (WHT).
9. CONNECT T4 TO Q7 (WHT).
10. CONNECT R4 TO S7 (WHT).
11. CONNECT SPRING 16 TO R9 (BLU).
12. CONNECT SPRING 17 TO Q9 (BLU).

2. TEST THE CIRCUIT

CHECK FOR WIRING ERRORS. BE SURE YOU HAVE NOT DISCONNECTED ANY WIRES ON THE RECEIVER CIRCUIT. REMOVE THE PHOTOTRANSISTOR CARD FROM THE CONSOLE SOCKET AND CONNECT IT TO THE CONSOLE USING THE REMOTE LINK. DIM THE ROOM LIGHTS TO PREVENT INTERFERENCE. ROTATE THE 1M CONSOLE POTENTIOMETER (R5) ALL THE WAY TO THE LEFT. PUSH THE POWER SWITCH ON. THE LED FLASHES VERY SLOWLY. ROTATE R5 TO THE RIGHT UNTIL THE LED FLASHES RAPIDLY. POINT THE PHOTOTRANSISTOR CARD AT THE LED. YOU WILL HEAR A LOUD BUZZ FROM THE CONSOLE SPEAKER. MOVE THE PHOTOTRANSISTOR CARD AWAY AND THE VOLUME OF THE BUZZ DECREASES SHARPLY. THE BUZZ MAY NOT ENTIRELY DISAPPEAR, EVEN WHEN THE PHOTOTRANSISTOR CARD IS COMPLETELY BLOCKED SINCE SOME OF THE PULSING SIGNAL IS SENT DIRECTLY TO THE RECEIVER. SOME OF THE SIGNAL IS SENT THROUGH THE SHARED POWER SUPPLY CONNECTIONS. THE REMAINDER IS SENT AS AN ELECTROMAGNETIC PULSE TO THE RECEIVER WIRES.

3. GOING FURTHER

THE RECEIVER IS VERY SENSITIVE. IF THIS IS A PROBLEM, REDUCE THE VALUE OF R3 IN THE RECEIVER CIRCUIT (PAGE 94) FROM 1M TO 100K (BRN-BLK-YEL) OR EVEN 10K (BRN-BLK-ORG).

GOING FURTHER WITH ELECTRONIC SENSORS

THERE ARE MANY CIRCUITS AND PROJECTS THAT YOU CAN BUILD USING YOUR RADIOSHACK ELECTRONIC SENSORS LAB. YOU CAN ALSO BUILD PERMANENT VERSIONS OF THE CIRCUITS IN THIS MANUAL OR CIRCUITS THAT YOU DESIGN. YOU CAN FIND STANDARD CIRCUIT BOARDS, ELECTRONIC PARTS, HARDWARE, ENCLOSURES, SOLDERING MATERIALS AND OTHER SUPPLIES AT RADIOSHACK. REMEMBER, OF COURSE, THAT THE CIRCUITS IN THIS MANUAL ARE FOR EDUCATIONAL USE, SCIENCE PROJECTS AND JUST PLAIN FUN. THEY ARE NOT DESIGNED FOR ANY HEALTH PURPOSE OR FOR ANY APPLICATION IN WHICH PROPERTY OR PEOPLE MIGHT BE INJURED.

HERE ARE SOME IDEAS FOR ADDITIONAL PROJECTS AND APPLICATIONS:

1. AROUND THE HOUSE

USE A PHOTOTRANSISTOR OR PHOTORESISTOR AND A LIGHT SOURCE TO DESIGN AN ANNUNCIATOR SYSTEM THAT SOUNDS A BUZZER WHEN A VISITOR AT YOUR FRONT DOOR BREAKS A LIGHT BEAM. USE A PHOTOTRANSISTOR, PHOTORESISTOR OR MAGNET AND MAGNET SWITCH TO BUILD AN ELECTRONIC MAILBOX INDICATOR THAT FLASHES AFTER THE MAILMAN OPENS YOUR MAILBOX. USE A PHOTOTRANSISTOR TO MAKE A PORTABLE TESTER FOR INFRARED REMOTE CONTROL UNITS.

2. SCIENCE PROJECTS

USE A LIGHT-SENSITIVE RADIOMETER TO RECORD THE LEVEL OF SUNLIGHT AT THE SAME LOCATION AT NOON FOR A FULL YEAR. ADJUST YOUR CIRCUIT SO THAT IT GIVES THE HIGHEST SIGNAL ON A BRIGHT, CLEAR SUMMER DAY. USE A THERMISTOR TO BUILD A REMOTE THERMOMETER THAT INDICATES TEMPERATURE WITH A BLINKING LED.

USE A MAGNET AND HALL SENSOR TO MAKE A SEISMOMETER SENSITIVE ENOUGH TO DETECT DISTANT EARTHQUAKES. YOU WILL KNOW YOUR CIRCUIT IS VERY SENSITIVE IF IT DETECTS TRAFFIC ON A NEARBY HIGHWAY.

3. EXPERIMENTAL CIRCUITS

SUBSTITUTE SENSORS OF YOUR OWN SELECTION INTO VARIOUS CIRCUITS DESCRIBED IN THIS MANUAL. FOR EXAMPLE, SOLAR CELLS ARE EXCELLENT LIGHT SENSORS. BE SURE TO OBSERVE THE SPECIFICATIONS OF THE SENSOR TO AVOID DAMAGING IT.

ADD DIGITAL INTEGRATED CIRCUITS TO YOUR SENSORS LAB KIT AND DESIGN CIRCUITS THAT INTERFACE SENSORS WITH DIGITAL CIRCUITS.

BUILD A LIGHT-SENSITIVE CIRCUIT THAT IS ACTIVATED BY A SPOT OF LIGHT ON A COMPUTER SCREEN. THEN WRITE A SIMPLE COMPUTER PROGRAM TO TRIGGER A BUZZER OR TONE WHEN THE LIGHT SPOT IS PRESENT.

4. JUST FOR FUN

USE A PHOTORESISTOR TO DESIGN AN ELECTRONIC MUSICAL INSTRUMENT THAT IS PLAYED BY A FLASHLIGHT BEAM.

USE A PHOTORESISTOR OR PHOTOTRANSISTOR TO MAKE AN OPTOELECTRONIC DART BOARD THAT TRIGGERS A BUZZER WHEN YOU MANAGE TO FLASH A SPOT OF LIGHT AT A TARGET. MOUNT THE LIGHT SENSOR AT THE CENTER OF THE TARGET.

USE A PHOTORESISTOR OR PHOTOTRANSISTOR TO MAKE A LIGHT-TRIGGERED BUZZER CIRCUIT AND PLACE IT IN A REFRIGERATOR. WHEN THE DOOR IS OPENED, THE BUZZER WILL SOUND.

GOING FURTHER WITH ELECTRONIC SENSORS

THERE ARE MANY CIRCUITS AND PROJECTS THAT YOU CAN BUILD USING YOUR RADIOSHACK ELECTRONIC SENSORS LAB. YOU CAN ALSO BUILD PERMANENT VERSIONS OF THE CIRCUITS IN THIS MANUAL OR CIRCUITS THAT YOU DESIGN. YOU CAN FIND STANDARD CIRCUIT BOARDS, ELECTRONIC PARTS, HARDWARE, ENCLOSURES, SOLDERING MATERIALS AND OTHER SUPPLIES AT RADIOSHACK. REMEMBER, OF COURSE, THAT THE CIRCUITS IN THIS MANUAL ARE FOR EDUCATIONAL USE, SCIENCE PROJECTS AND JUST PLAIN FUN. THEY ARE NOT DESIGNED FOR ANY HEALTH PURPOSE OR FOR ANY APPLICATION IN WHICH PROPERTY OR PEOPLE MIGHT BE INJURED.

HERE ARE SOME IDEAS FOR ADDITIONAL PROJECTS AND APPLICATIONS:

1. AROUND THE HOUSE

USE A PHOTOTRANSISTOR OR PHOTORESISTOR AND A LIGHT SOURCE TO DESIGN AN ANNUNCIATOR SYSTEM THAT SOUNDS A BUZZER WHEN A VISITOR AT YOUR FRONT DOOR BREAKS A LIGHT BEAM. USE A PHOTOTRANSISTOR, PHOTORESISTOR OR MAGNET AND MAGNET SWITCH TO BUILD AN ELECTRONIC MAILBOX INDICATOR THAT FLASHES AFTER THE MAILMAN OPENS YOUR MAILBOX. USE A PHOTOTRANSISTOR TO MAKE A PORTABLE TESTER FOR INFRARED REMOTE CONTROL UNITS.

2. SCIENCE PROJECTS

USE A LIGHT-SENSITIVE RADIOMETER TO RECORD THE LEVEL OF SUNLIGHT AT THE SAME LOCATION AT NOON FOR A FULL YEAR. ADJUST YOUR CIRCUIT SO THAT IT GIVES THE HIGHEST SIGNAL ON A BRIGHT, CLEAR SUMMER DAY. USE A THERMISTOR TO BUILD A REMOTE THERMOMETER THAT INDICATES TEMPERATURE WITH A BLINKING LED.

USE A MAGNET AND HALL SENSOR TO MAKE A SEISMOMETER SENSITIVE ENOUGH TO DETECT DISTANT EARTHQUAKES. YOU WILL KNOW YOUR CIRCUIT IS VERY SENSITIVE IF IT DETECTS TRAFFIC ON A NEARBY HIGHWAY.

3. EXPERIMENTAL CIRCUITS

SUBSTITUTE SENSORS OF YOUR OWN SELECTION INTO VARIOUS CIRCUITS DESCRIBED IN THIS MANUAL. FOR EXAMPLE, SOLAR CELLS ARE EXCELLENT LIGHT SENSORS. BE SURE TO OBSERVE THE SPECIFICATIONS OF THE SENSOR TO AVOID DAMAGING IT.

ADD DIGITAL INTEGRATED CIRCUITS TO YOUR SENSORS LAB KIT AND DESIGN CIRCUITS THAT INTERFACE SENSORS WITH DIGITAL CIRCUITS.

BUILD A LIGHT-SENSITIVE CIRCUIT THAT IS ACTIVATED BY A SPOT OF LIGHT ON A COMPUTER SCREEN. THEN WRITE A SIMPLE COMPUTER PROGRAM TO TRIGGER A BUZZER OR TONE WHEN THE LIGHT SPOT IS PRESENT.

4. JUST FOR FUN

USE A PHOTORESISTOR TO DESIGN AN ELECTRONIC MUSICAL INSTRUMENT THAT IS PLAYED BY A FLASHLIGHT BEAM.

USE A PHOTORESISTOR OR PHOTOTRANSISTOR TO MAKE AN OPTOELECTRONIC DART BOARD THAT TRIGGERS A BUZZER WHEN YOU MANAGE TO FLASH A SPOT OF LIGHT AT A TARGET. MOUNT THE LIGHT SENSOR AT THE CENTER OF THE TARGET.

USE A PHOTORESISTOR OR PHOTOTRANSISTOR TO MAKE A LIGHT-TRIGGERED BUZZER CIRCUIT AND PLACE IT IN A REFRIGERATOR. WHEN THE DOOR IS OPENED, THE BUZZER WILL SOUND.