

Electronic Kits International Inc.

SCIENCE ELECTRONIC LAB

LAB
#16-30

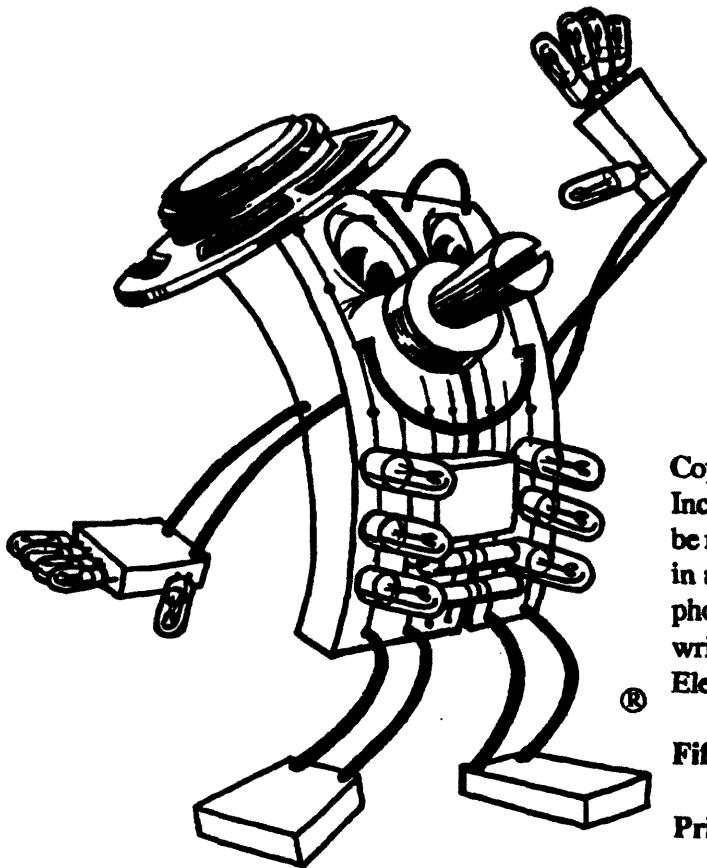

Written and Developed for EKI, Inc. by
Jorge L Tallercio, Electrical Engineer.

Technical Drawings by Carlos Quintana

Illustrations by Tom Howell

Editors: Gary Gibson
Douglas Gibson

Copyright © 1992 by Electronic Kits International
Inc. all rights reserved. No parts of this publication may
be reproduced, stored in retrieval system, or transmitted
in any forms or by any means, electronic, mechanical,
photocopying, recording, or otherwise, without the prior
written permission of the publisher.

Electronic Kits International Inc.

Fifth Edition.

Printed In The United States Of America

Mr. CIRCUIT®

Mr. CIRCUIT[®]

Solderless Electronic Kit

ELECTRONIC MOTORCYCLE

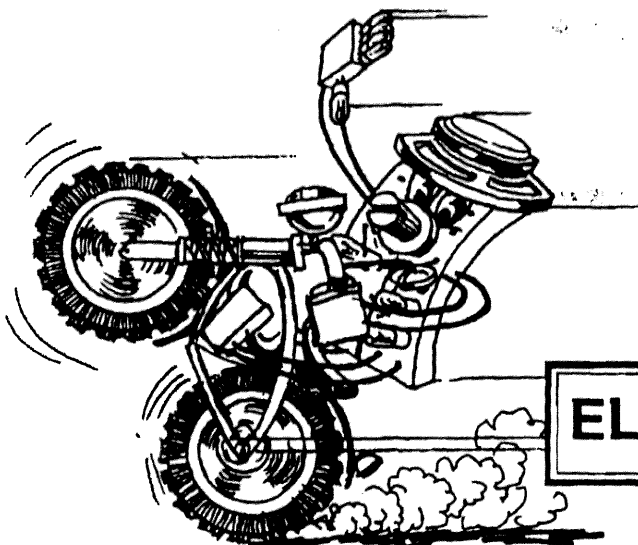

LAB KIT A16

*** START HERE ***

(A) PURPOSE OF THIS PROJECT.

To build an electronic project that generates the sound of a motorcycle, starting and speeding up.

(B) CIRCUIT DESCRIPTION

With this project you can generate the sound of a motorcycle starting and speeding up.

You can accelerate or slow down your electronic motorcycle by rotating potentiometer R2.

The circuit of the Electronic Motorcycle consists

of a low frequency two-transistor oscillator, similar to the one explained in Mr. Circuit Lab Kit A10.

The frequency of this oscillator (speed of the motorcycle) is controlled by potentiometer R2. Adjusting R2 you can accelerate or slow down the motorcycle.

Now you are ready to assemble this project.

SCHMATIC DIAGRAM & PARTS LIST

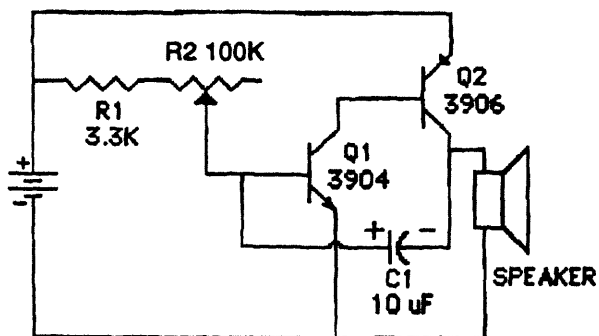

- | | |
|------------------------------|---------|
| - Battery Snap | Part # |
| - R1: 3.3K ohm | SL35001 |
| - R2: 100K ohm Potentiometer | SL01077 |
| - Q1: 2N3904 Transistor | SL33008 |
| - Q2: 2N3906 Transistor | SL18001 |
| - C1: 10 μ F Capacitor | SL18002 |
| - Speaker | SL05003 |
| | SL27001 |



(C) Step By Step Assembly Instructions

ELECTRONIC MOTORCYCLE / LAB KIT A16

GET THE SOLDERLESS CIRCUIT BOARD AND BUILD THE PROJECT ALWAYS COMPARING YOUR WORK TO THE ASSEMBLY DIAGRAM.

() **STEP 1.**

Find the Battery Snap. Insert the red wire into hole 1f, and the black wire into hole 1e.



() **STEP 2.**

Get one wire. Insert one end in hole 1j and the other end in hole 9j, as shown in the pictorial diagram.



() **STEP 3.**

Find the 3.3K ohm resistor (Orange, Orange, Red, Gold). Insert one lead into hole 1h, and the other into hole 8h.



() **STEP 4.**

Find the 3904 transistor. Insert its leads into holes 13d, 14d and 15d. Be sure its flat side is pointing in the direction shown in the assembly diagram.



() **STEP 5.**

Find the 3906 transistor. Insert its leads into holes 18d, 19d and 20d. Be sure its flat side is pointing in the direction shown in the assembly diagram.



() **STEP 6.**

Find the 10µF capacitor. Install its positive lead (long lead) into hole 14b, and its negative lead (short lead) into hole 20b.



() **STEP 7.**

Find the potentiometer. Insert the wire connected to the center lead into hole 8j, and the wire connected to the left lead into hole 14e.

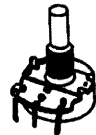

() **STEP 8.**

Find the speaker. Insert one of its leads into hole 15a, and the other into hole 20a.



() **STEP 9.**

Get three wires. Install them as follows: one from 1a to 15b, one from 9f to 18e, and one from 13c to 19c.



() **STEP 10.**

STOP! Before you test your project verify it against the Assembly Diagram, to be sure that all the components are installed in the right place. Also be sure that there are no short circuits on the board (wires or leads touching each other).



EKI.

ELECTRONIC MOTORCYCLE ASSEMBLY DIAGRAM

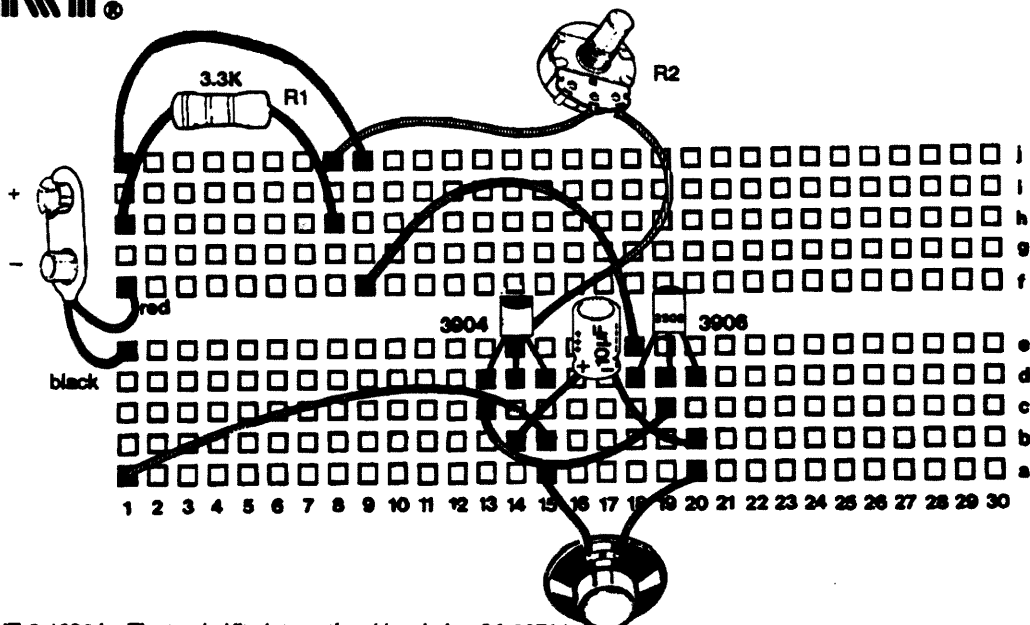

Mr. CIRCUIT[®]

Solderless Electronic Kit

RAILROAD LIGHTS

LAB KIT A17

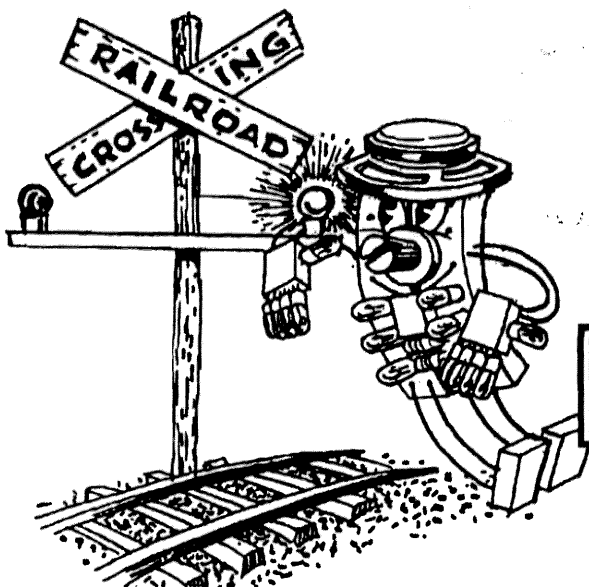

*** START HERE ***

(A) PURPOSE OF THIS PROJECT.

To build an electronic project that alternately flashes a pair of LEDs.

(B) CIRCUIT DESCRIPTION

The Railroad Lights project alternately flashes a pair of LEDs at the rate of about two blinks per second, producing the same effect as railroad signals. To operate this device, just connect the battery to the battery snap.

The circuit of the Railroad Lights is basically made of a 555 Timer working as a clock, similar to the one explained in Mr. Circuit Lab Kit A11. Two LEDs in

opposite polarity, are connected to the output of the clock (pin 3 of the 555) through two 220 ohm resistors.

When pin 3 of the 555 is positive (High) LED2 will be forward biased (anode positive, cathode negative) and LED1 reverse biased, therefore, LED2 will light and LED1 will remain off. The opposite situation occurs when pin 3 is negative.

Now you are ready to assemble the project.

SCHEMATIC DIAGRAM & PARTS LIST

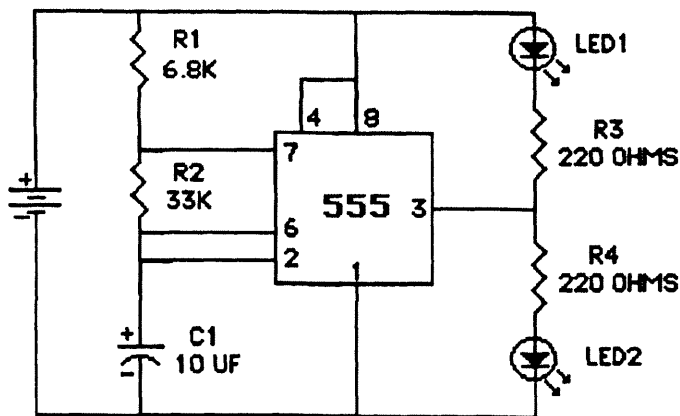

	Part #
- Battery Snap	SL35001
- R1: 6.8K ohm	SL01085
- R2: 33K ohm	SL01101
- R3: 220 ohm	SL01049
- R4: 220 ohm	SL01049
- 555 IC Timer	SL14004
- C1: 10 µF Capacitor	SL05003
- LED1 & LED2: LEDs	SL06001



Mr. Circuit Solderless Electronic Kit

(C) Step By Step Assembly Instructions

RAILROAD LIGHTS / LAB KIT A17

GET THE SOLDERLESS CIRCUIT BOARD AND BUILD THE PROJECT ALWAYS COMPARING YOUR WORK TO THE ASSEMBLY DIAGRAM.

() **STEP 1.**

Find the Battery Snap. Insert the red wire into hole 1f, and the black wire into hole 1e.



() **STEP 2.**

Find the Integrated Circuit 555. Install it in the board with the notch, dot or band at one end in the right direction, as shown in the assembly diagram (holes: 10e, 11e, 12e, 13e, 10f, 11f, 12f, 13f).



() **STEP 3.**

Find the 6.8K ohm resistor (Blue, Gray, Red, Gold). Insert one lead into hole 10i, and the other into hole 11i.



() **STEP 4.**

Find the 33K ohm resistor (Orange, Orange, Orange, Gold). Insert one lead into hole 11h, and the other into hole 12h.



() **STEP 5.**

Find one 220 ohm resistor (Red, Red, Brown, Gold). Insert one lead into hole 12c, and the other into hole 22f.



() **STEP 6.**

Find one 220 ohm resistor (Red, Red, Brown, Gold). Insert one lead into hole 12b, and the other into hole 22c.



() **STEP 7.**

Find the 10µF capacitor. Install its positive lead (long lead) into hole 11c, and its negative lead (short lead) into hole 10c.



() **STEP 8.**

Find one red LED (light emitting diode). Insert its long lead into hole 21i, and the short lead into hole 22i.



() **STEP 9.**

Find one red LED (light emitting diode). Insert its long lead into hole 22a, and the short lead into hole 21a.



() **STEP 10.**

Get six wires. Install them as follows: one from 1j to 10j, one from 10h to 21h, one from 1a to 10a, one from 10b to 21b, one from 10g to 13d and one from 12g to 11d.

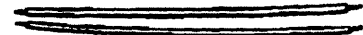

() **STEP 11.**

STOP! Before you test your project verify it against the Assembly Diagram, to be sure that all the components are installed in the right place. Also be sure that there are no short circuits on the board (wires or leads touching each other).

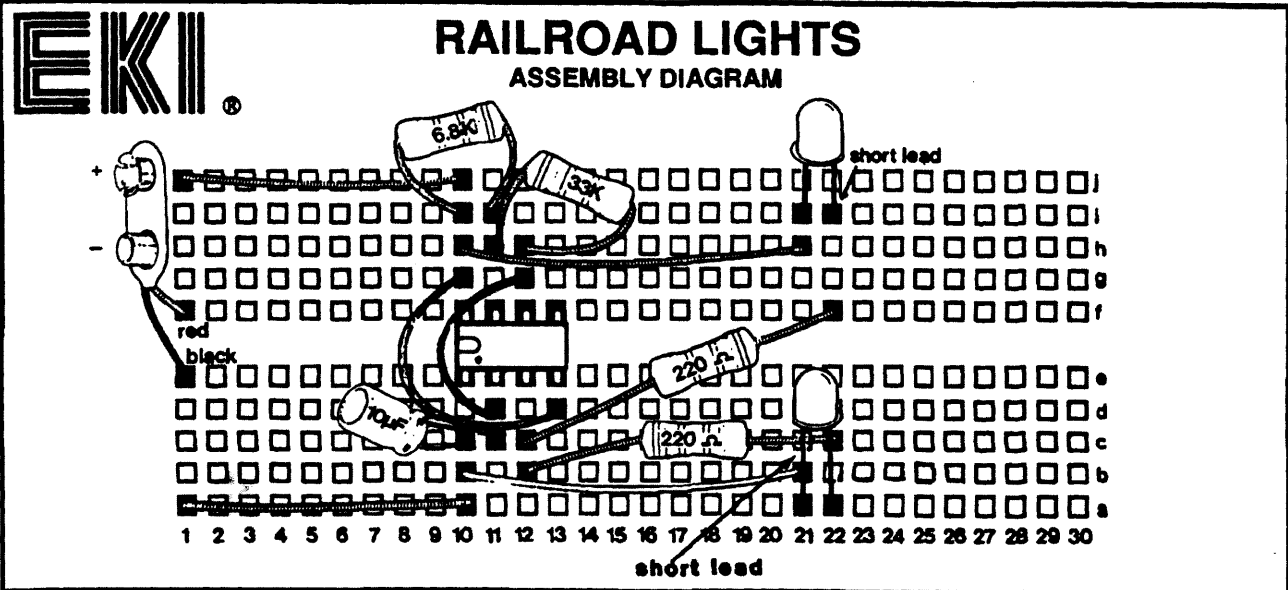

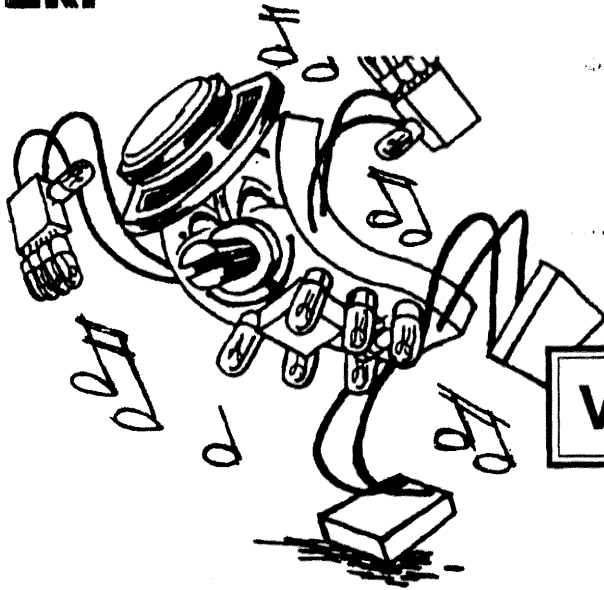

Mr. CIRCUIT[®]

Solderless Electronic Kit

VARIABLE SPEED LIGHTS

LAB KIT A18

*** START HERE ***

(A) PURPOSE OF THIS PROJECT.

To build an electronic project that alternately flashes a pair of LEDs at an adjustable speed.

(B) CIRCUIT DESCRIPTION

The Variable Speed Lights alternately flashes a pair of LEDs at a rate that can be adjusted through a potentiometer, producing an interesting light display.

To operate this project, just connect the battery to the battery snap and adjust the speed of the flashing lights by rotating potentiometer R5.

The circuit of the Variable Speed Lights is basically made of a 555 IC Timer operating as a clock, similar to the one explained in Mr. Circuit Lab Kit A11. The frequency of the pulses produced by the clock can be adjusted by potentiometer R5. Two LEDs in opposite polarity, which alternately light up, are connected to the output of the clock.

Now you are ready to assembly this project.

SCHEMATIC DIAGRAM & PARTS LIST

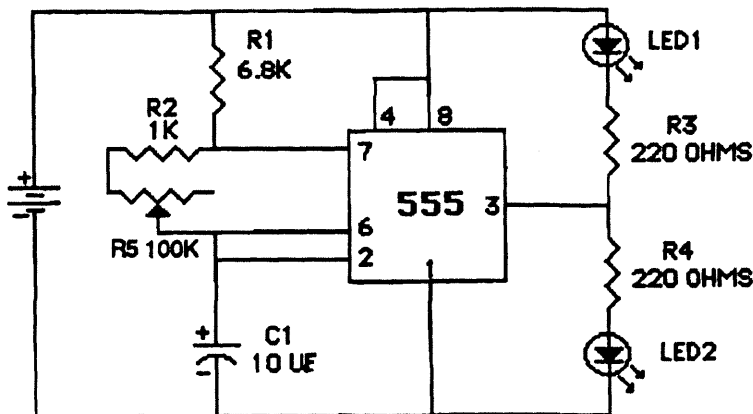

- | | Part # |
|----------------------------|---------|
| - Battery Snap | SL35001 |
| - R1: 6.8K ohm | SL01085 |
| - R2: 1K ohm | SL01065 |
| - R3: 220 ohm | SL01049 |
| - R4: 220 ohm | SL01049 |
| - R5: 100K ohm Pot. | SL33008 |
| - 555 IC Timer | SL14004 |
| - C1: 10 μ F Capacitor | SL05003 |
| - LED1 & LED2: LEDs | SL06001 |



(C) Step By Step Assembly Instructions

VARIABLE SPEED LIGHTS / LAB KIT A18

GET THE SOLDERLESS CIRCUIT BOARD AND BUILD THE PROJECT ALWAYS COMPARING YOUR WORK TO THE ASSEMBLY DIAGRAM.

() STEP 1.

Find the Battery Snap. Insert the red wire into hole 1f, and the black wire into hole 1e.



() STEP 2.

Find the Integrated Circuit 555. Install it in the board with the notch, dot or band at one end in the right direction, as shown in the assembly diagram (holes: 9e, 10e, 11e, 12e, 9f, 10f, 11f, 12f).



() STEP 3.

Find the 6.8K ohm resistor (Blue, Gray, Red, Gold). Insert one lead into hole 9i, and the other into hole 10j.



() STEP 4.

Find the 1K ohm resistor (Brown, Black, Red, Gold). Insert one lead into hole 4h, and the other into hole 10h.



() STEP 5.

Find two 220 ohm resistors (Red, Red, Brown, Gold). Insert one from hole 11d to 19f, and the other from hole 11c to hole 18c.



() STEP 6.

Find the 10µF capacitor. Install its positive lead (long lead) into hole 10b, and its negative lead (short lead) into hole 9b.



() STEP 7.

Find two red LEDs (light emitting diode). Install one with its long lead into hole 18j, and the short lead into hole 19j. Install the other with its long lead into hole 18b and the short lead into hole 19b.



() STEP 8.

Find the potentiometer. Insert the center wire into hole 4i and the left wire into hole 11h.



() STEP 9.

Get six wires. Install them as follows: one from 1j to 18i, one from 1i to 9j, one from 9g to 12d, one from 11g to 10d, one from 1b to 9a and one from 1a to 19a.

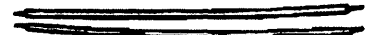

() STEP 10.

STOP! Before you test your project verify it against the Assembly Diagram, to be sure that all the components are installed in the right place. Also be sure that there are no short circuits on the board (wires or leads touching each other).

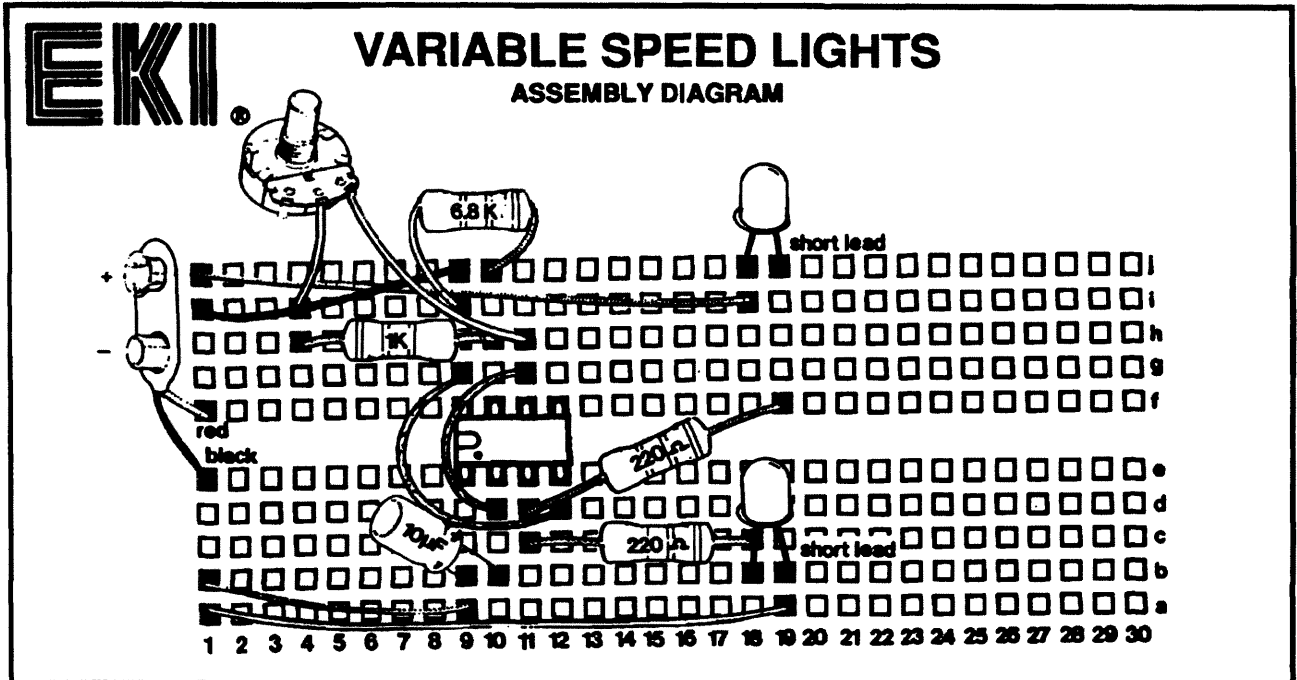

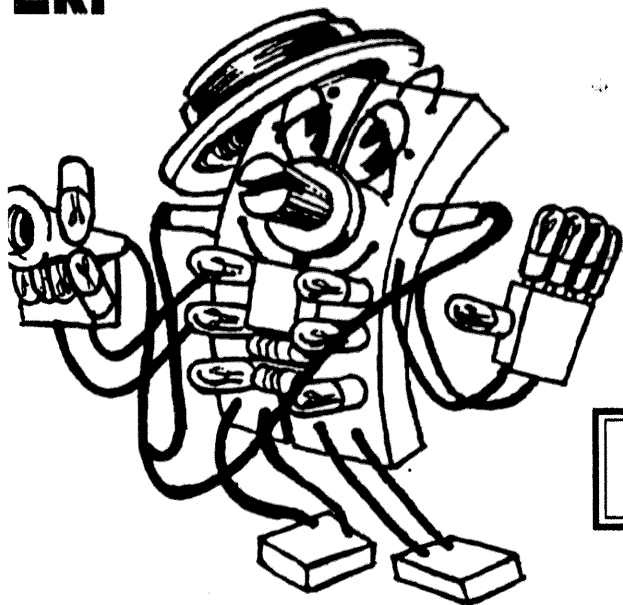

Mr. CIRCUIT[®]

Solderless Electronic Kit

CONTINUITY TESTER

LAB KIT A19

*** START HERE ***

(A) PURPOSE OF THIS PROJECT.

To build an useful Continuity Tester.

(B) CIRCUIT DESCRIPTION

The audible Continuity Tester provides a convenient way to check for open circuits, broken wires, bad connections or to test light bulbs or fuses.

To operate it, just connect a fresh 9-volt battery to the battery snap and touch the two probes (wires) of the device to the leads of the circuit under test (fuse, lamp, wire, etc.). If there is electrical continuity in the tested circuit, the Continuity tester will emit a loud

sound. If the circuit is open, no sound will be emitted.

The circuit of the Continuity Tester is basically made of a 555 timer working as a clock, similar to the one explained in Mr. Circuit Lab Kit A11. When there is electrical continuity between the two probes, the 555 generates an audio signal which is amplified by the transistor Q1 and then reproduced by the speaker. Now you are ready to assemble the project.

SCHEMATIC DIAGRAM & PARTS LIST

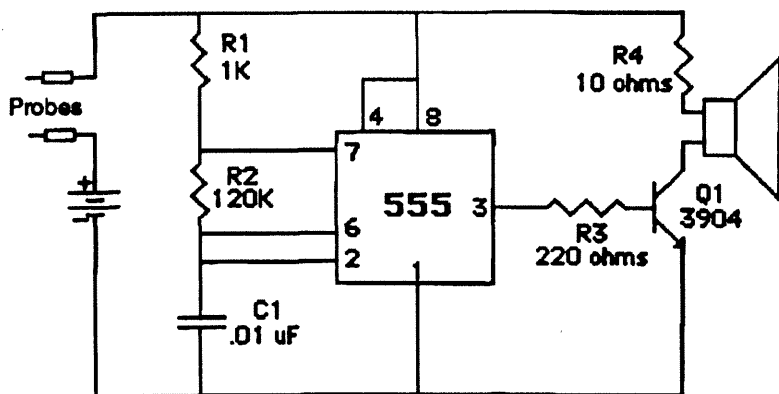

- | | Part # |
|-------------------------|---------|
| - Battery Snap | SL35001 |
| - R1: 1K ohm | SL01065 |
| - R2: 120K ohm | SL01115 |
| - R3: 220 ohm | SL01049 |
| - R4: 10 ohm | SL01017 |
| - C1: .01 μ F Cap. | SL02012 |
| - 555 IC Timer | SL14004 |
| - Q1: 2N3904 Transistor | SL18001 |
| - Speaker | SL27001 |



Mr. Circuit Solderless Electronic Kit

(C) Step By Step Assembly Instructions

CONTINUITY TESTER / LAB KIT A19

GET THE SOLDERLESS CIRCUIT BOARD AND BUILD THE PROJECT ALWAYS COMPARING YOUR WORK TO THE ASSEMBLY DIAGRAM.

() STEP 1.

Find the Battery Snap. Insert the red wire into hole 1f, and the black wire into hole 1e.



() STEP 2.

Find the Integrated Circuit 555. Install it in the board with the notch, dot or band at one end in the right direction, as shown in the assembly diagram (holes: 15e, 16e, 17e, 18e, 15f, 16f, 17f, 18f).



() STEP 3.

Find the 1K ohm resistor (Brown, Black, Red, Gold). Insert one lead into hole 15h, and the other into hole 16i.



() STEP 4.

Find the 120K ohm resistor (Brown, Red, Yellow, Gold). Insert one lead into hole 16j, and the other into hole 17j.



() STEP 5.

Find the 10 ohm resistor (Brown, Black, Black, Gold). Insert one lead into hole 20j and the other into hole 23j.



() STEP 6.

Find the 220 ohm resistor (Red, Red, Brown, Gold). Insert one lead into hole 17c, and the other into hole 25c.



() STEP 7.

Find the .01µF (103) capacitor. Insert one lead into hole 15c and the other into hole 16b.



() STEP 8.

Find the 3904 transistor. Insert its leads into holes 24d, 25d and 26d. Be sure its flat side is pointing in the direction shown in the assembly diagram.



() STEP 9.

Find the speaker. Insert one of its leads into hole 23h and the other into hole 24a.



() STEP 10.

Get eight wires. Install six as follows: one from 2j to 20i, one from 2h to 15i, one from 15g to 18c, one from 16d to 17g, one from 1c to 15a and one from 1a to 26a.

Install one wire into hole 1g and another wire into hole 2g. Do not connect the other side of these wires. These two wires are the probes of the continuity tester.



() STEP 11

STOP! Before you test your project verify it against the Assembly Diagram, to be sure that all the components are installed in the right place. Also be sure that there are no short circuits on the board (wires or leads touching each other).

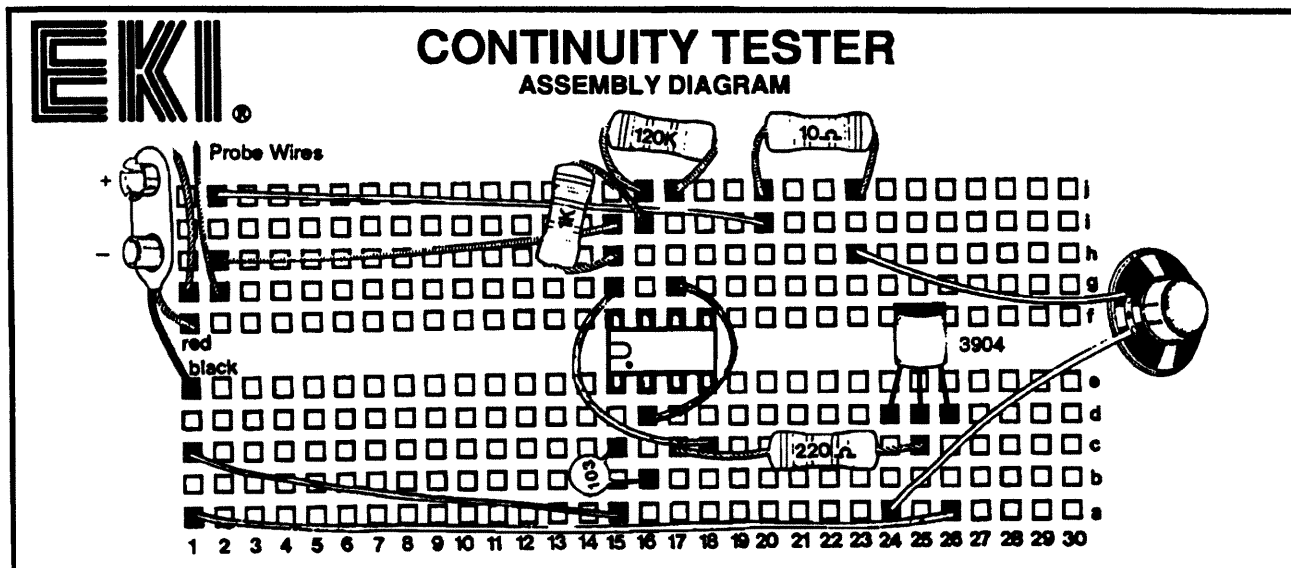

Mr. CIRCUIT[®]

Solderless Electronic Kit

AUDIO GENERATOR

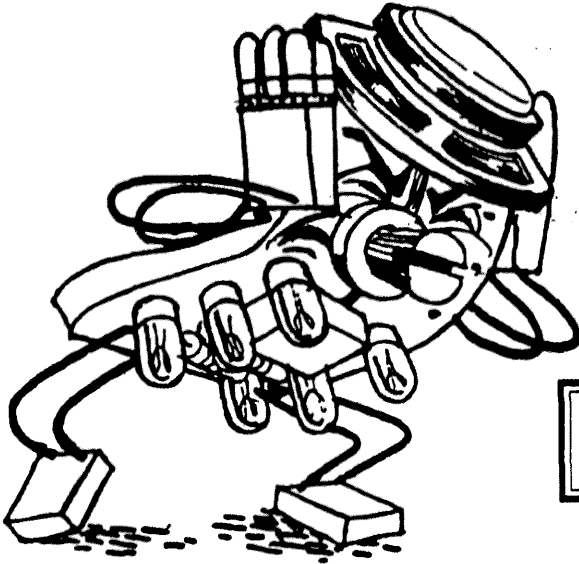

LAB KIT A20

*** START HERE ***

(A) PURPOSE OF THIS PROJECT.

To build an useful and fun Audio Generator

(B) CIRCUIT DESCRIPTION

As its name implies, this project generates an audio signal (an electrical signal that is able to be heard through the speaker) of adjustable pitch (tone).

To operate this circuit, just connect the battery to the battery snap and then rotate the potentiometer R5 to adjust the pitch of the audio signal.

The circuit of the Audio Generator is basically made of a 555 timer working as a clock, similar to the one explained in Mr. Circuit Lab Kit A11. Potentiometer R5 controls the frequency of the audio signal generated by the clock. Transistor Q1 amplifies the audio signal which is then reproduced by the speaker.

SCHMATIC DIAGRAM & PARTS LIST

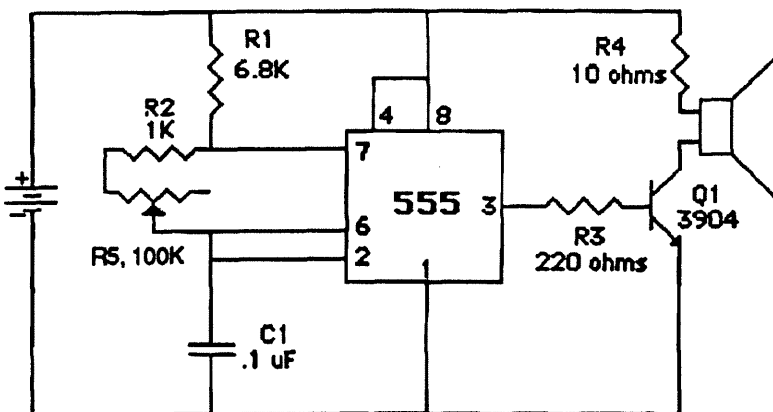

	Part #
- Battery Snap	SL35001
- R1: 6.8K ohm	SL01085
- R2:1K ohm	SL01065
- R3: 220 ohm	SL01049
- R4: 10 ohm	SL01017
- R5: 100K ohm Pot.	SL33008
- C1: .1 μ F Cap.	SL02016
- 555 IC Timer	SL14004
- Q1: 2N3904 Transistor	SL18001
- Speaker	SL27001



(C) Step By Step Assembly Instructions

AUDIO GENERATOR / LAB KIT A20

GET THE SOLDERLESS CIRCUIT BOARD AND BUILD THE PROJECT ALWAYS COMPARING YOUR WORK TO THE ASSEMBLY DIAGRAM.

() STEP 1.

Find the Battery Snap. Insert the red wire into hole 2f, and the black wire into hole 2e.



() STEP 2.

Find the Integrated Circuit 555. Install it in the board with the notch, dot or band at one end in the right direction, as shown in the assembly diagram (holes: 15e, 16e, 17e, 18e, 15f, 16f, 17f, 18f).



() STEP 3.

Find and install the following resistors:
- 1K ohm (Brown, Black, Red, Gold) from hole 9f to hole 16g.
- 6.8K ohm (Blue, Gray, Red, Gold) from hole 15j to hole 16j.
- 10 ohm (Brown, Black, Black, Gold) from hole 21i to hole 24i.
- 220 ohms (Red, Red, Brown, Gold) from hole 17d to hole 23c.

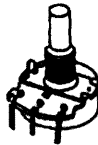

() STEP 4.

Find the potentiometer. Insert the center lead wire into hole 9g and the left lead wire into hole 17i.

() STEP 5.

Find the .1µF (104) capacitor. Insert one lead into hole 15c and the other into hole 16b.



() STEP 6.

Find the 3904 transistor. Insert its leads into holes 22d, 23d and 24d. Be sure its flat side is pointing in the direction shown in the assembly diagram.



() STEP 7.

Find the speaker. Insert one of its leads into hole 22a and the other into hole 24h.



() STEP 8.

Get six wires. Install them as follows: one from 2j to 15i, one from 2i to 21j, one from 15h to 18d, one from 16d to 17g, one from 2b to 15a and one from 2a to 24a.

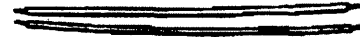

() STEP 9.

STOP! Before you test your project verify it against the Assembly Diagram, to be sure that all the components are installed in the right place. Also be sure that there are no short circuits on the board (wires or leads touching each other).

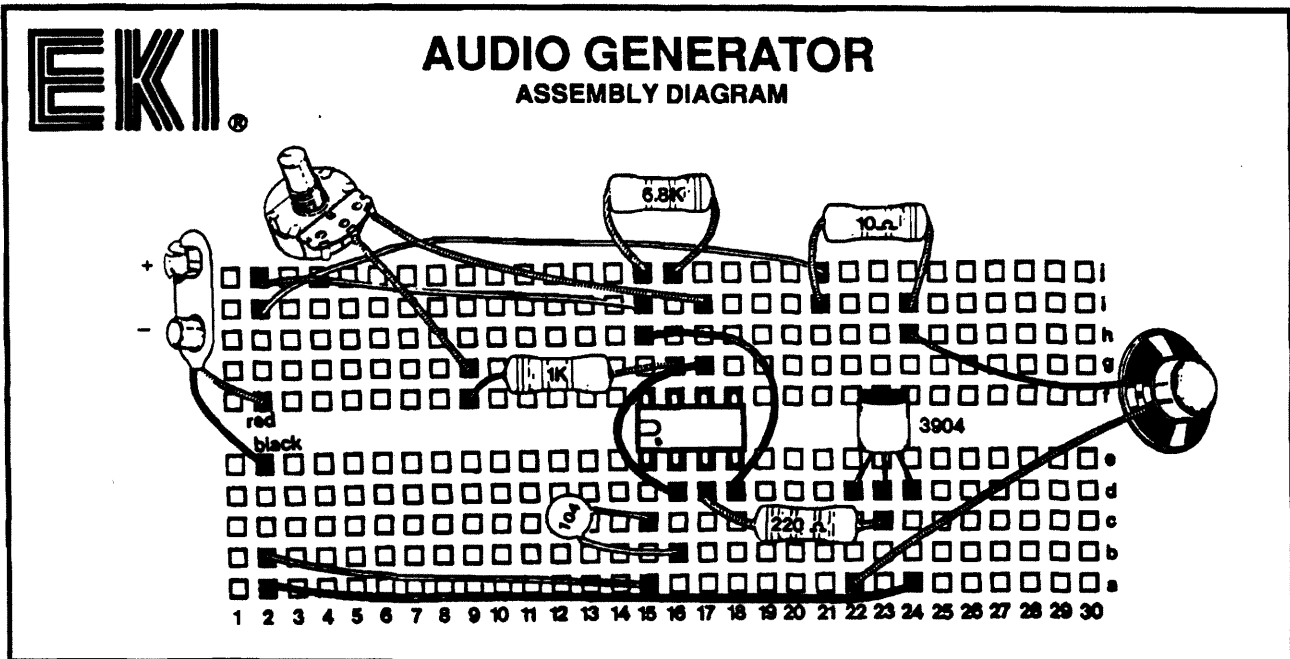

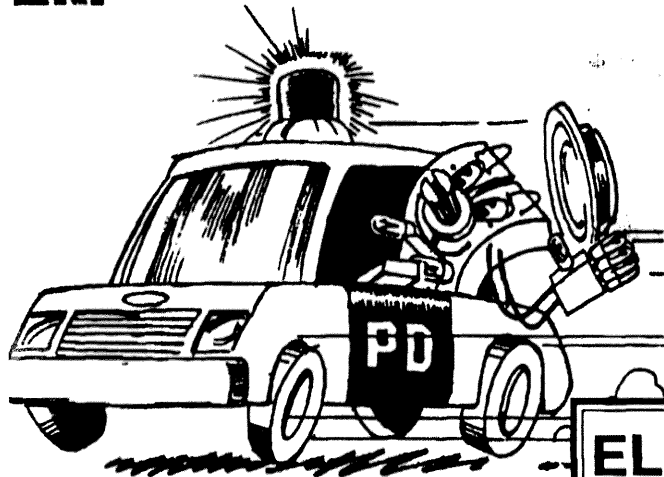

Mr. CIRCUIT[®]

Solderless Electronic Kit

ELECTRONIC POLICE SIREN

*** START HERE ***

LAB KIT A21

(A) PURPOSE OF THIS PROJECT.

To build an useful and fun electronic project that generates the sound of a police siren.

(B) CIRCUIT DESCRIPTION

This exciting project will give you and your friends lots of fun. It produces a siren sound of rising and falling pitch.

To operate it, just connect the battery to the battery snap. Press the pushbutton S1 to produce a steadily rising tone from the speaker. Release the pushbutton and the tone descends in pitch. Thus you control the overall rising and falling pitch of the siren with the closing and opening of pushbutton S1.

The circuit of the Electronic Police Siren is basically made of a 555 timer working as a clock, similar to the one explained in Mr. Circuit Lab Kit A11. It has an audio amplifier section consisting of transistor Q1 and the speaker. The frequency of the 555 clock is controlled by the voltage applied on pin 5 which is generated by the charge and discharge of capacitor C2. C2 discharges when the pushbutton is pressed and charges when it is open, producing the rising and falling of the pitch of the siren.

Now you are ready to assembly the project.

SCHMATIC DIAGRAM & PARTS LIST

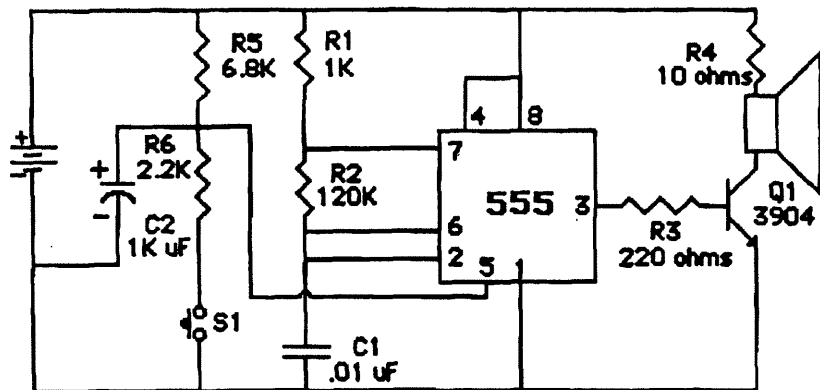

	Part #
- Battery Snap	SL35001
- R1: 1K ohm	SL01065
- R2: 120K ohm	SL01115
- R3: 220 ohm	SL01049
- R4: 10 ohm	SL01017
- R5: 6.8K ohm	SL01085
- R6: 2.2K ohm	SL01073
- C1: .01 μ F Cap.	SL02012
- C2: 1000 μ F Cap.	SL05005
- S1: Pushbutton	SL25004
- 555 IC Timer	SL14004
- Q1: 2N3904 Transistor	SL18001
- Speaker	SL27001



Mr. Circuit Solderless Electronic Kit

(C) Step By Step Assembly Instructions

ELECTRONIC POLICE SIREN / LAB KIT A21

GET THE SOLDERLESS CIRCUIT BOARD AND BUILD THE PROJECT ALWAYS COMPARING YOUR WORK TO THE ASSEMBLY DIAGRAM.

() STEP 1.

Find the Battery Snap. Insert the red wire into hole 2g, and the black wire into hole 1e.



() STEP 2.

Find the Integrated Circuit 555. Install it in the board with the notch, dot or band at one end in the right direction, as shown in the assembly diagram (holes: 17e, 18e, 19e, 20e, 17f, 18f, 19f, 20f).



() STEP 3.

Find and install the following resistors:
- 1K ohm (Brown, Black, Red, Gold) from hole 17h to hole 18h.
- 6.8K ohm (Blue, Gray, Red, Gold) from hole 2h to hole 11h.
- 2.2K ohm (Red, Red, Red, Gold) from hole 2e to hole 11g.
- 220 ohms (Red, Red, Brown, Gold) from hole 19d to hole 25c.
- 120K ohm (Brown, Red, Yellow, Gold) from 18j to 19j.
- 10 ohms (Brown, Black, Black, Gold) from 24j to 25j.



() STEP 4.

Find the pushbutton switch. Insert one lead into hole 1c and the other into hole 2d.



() STEP 5.

Find the .01µF (103) capacitor. Insert one lead into hole 17c and the other into hole 18c.

() STEP 6.

Find the 1000 µF capacitor. Insert its positive lead (long lead) into hole 11f, and its negative lead (short lead) into hole 11c.

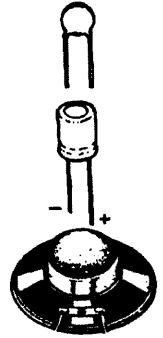

() STEP 7.

Find the speaker. Insert one of its leads into hole 25i and the other into hole 24a.

() STEP 8.

Find the 3904 transistor. Insert its leads into holes 24d, 25d and 26d. Be sure its flat side is pointing in the direction shown in the assembly diagram.



() STEP 9.

Get eight wires. Install them as follows: one from 2j to 17j, one from 11i to 20i, one from 17i to 24h, one from 19h to 18d, one from 17g to 20d and one from 1b to 11b, one from 1a to 17b and one from 17a to 26a.

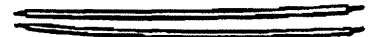

() STEP 10.

STOP! Before you test your project verify it against the Assembly Diagram, to be sure that all the components are installed in the right place. Also be sure that there are no short circuits on the board (wires or leads touching each other).

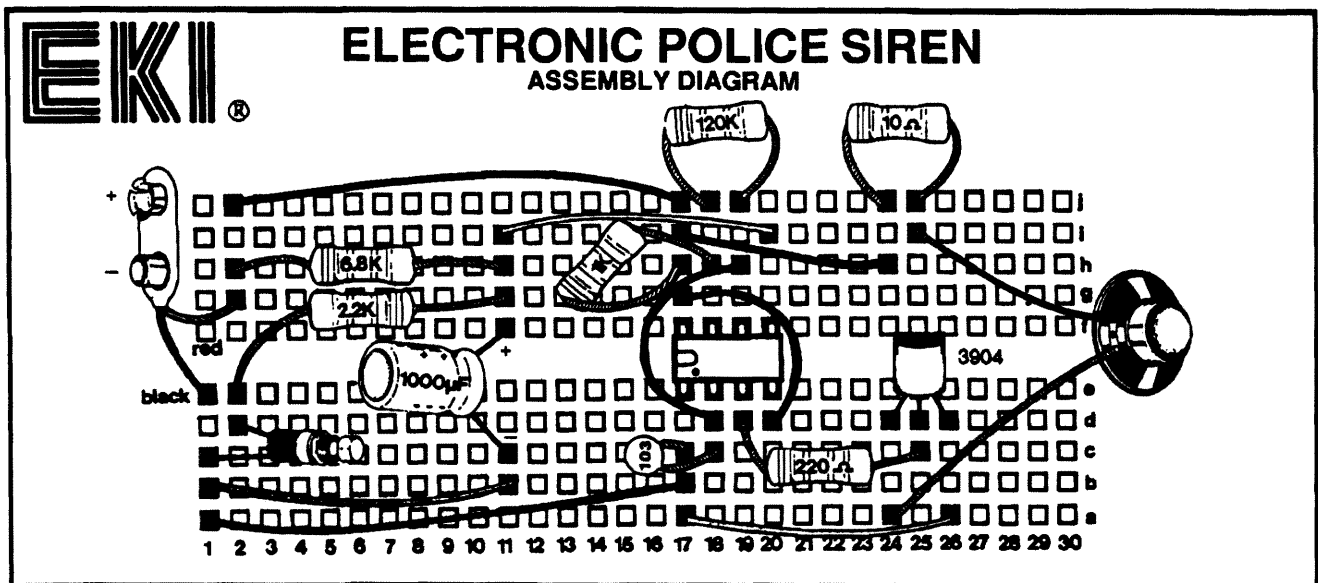

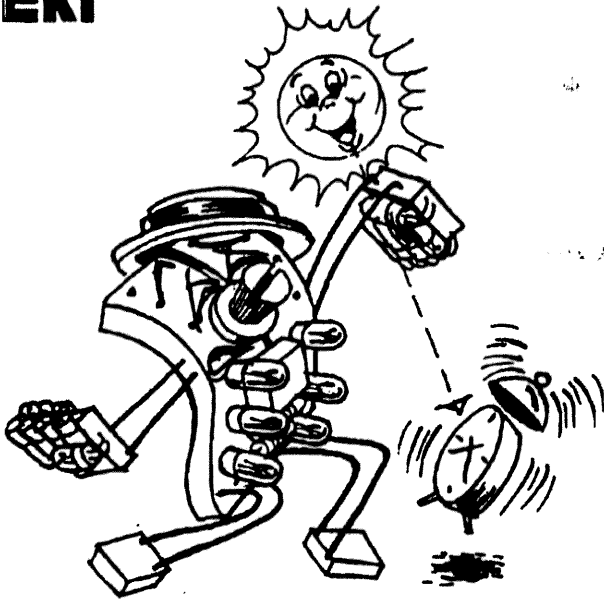

Mr. CIRCUIT[®]

Solderless Electronic Kit

WAKE-UP ALARM

LAB KIT A22

*** START HERE ***

(A) PURPOSE OF THIS PROJECT.

To build an useful and fun electronic project that generates a sound when light hits its photocell.

(B) CIRCUIT DESCRIPTION

This little amazing device will give you lots of fun in your office, school or camp. The wake-up alarm generates a loud sound only when light hits its photocell. In the darkness it remains silent. Therefore, you can use it to wake you up or to scare your friends by hiding it in a drawer (drawer closed, no sound; drawer open, sound).

The pitch of the sound also depends on the intensity of the light hitting the photocell. Therefore, you can produce interesting sound effects by shadowing with your hand the surface of the photocell.

To operate the Wake-Up Alarm, just connect the battery to the battery snap.

The circuit of this device consists of a 555 IC Timer working as a clock, similar to the one explained in Mr. Circuit Lab Kit A11. It generates an audio signal having a frequency which is dependent upon the intensity of the light on the photocell. The audio signal generated by the 555 is amplified by transistor Q1 and then reproduced by the speaker.

Now you are ready to assemble this project.

SCHEMATIC DIAGRAM & PARTS LIST

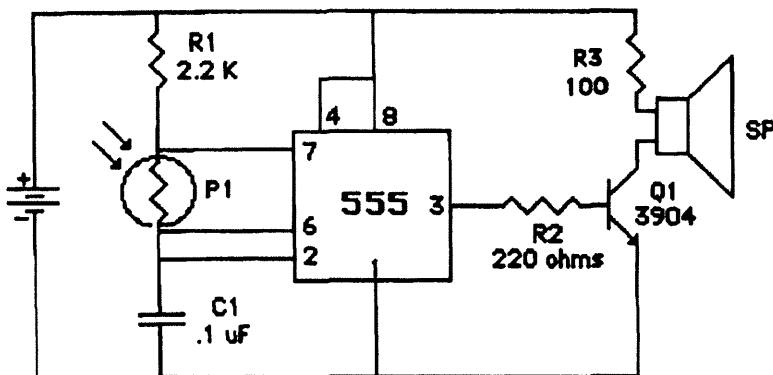

- | | Part # |
|-------------------------|---------|
| - Battery Snap | SL35001 |
| - R1: 2.2K ohm | SL01073 |
| - R2: 220 ohm | SL01049 |
| - R3: 100 ohm | SL01041 |
| - P1: Photocell | SL45028 |
| - C1: .1 μ F Cap. | SL02016 |
| - 555 IC Timer | SL14004 |
| - Q1: 2N3904 Transistor | SL18001 |
| - Speaker | SL27001 |



Mr. Circuit Solderless Electronic Kit

(C) Step By Step Assembly Instructions

WAKE-UP ALARM / LAB KIT A22

GET THE SOLDERLESS CIRCUIT BOARD AND BUILD THE PROJECT ALWAYS COMPARING YOUR WORK TO THE ASSEMBLY DIAGRAM.

() STEP 1.

Find the Battery Snap. Insert the red wire into hole 1f, and the black wire into hole 1e.



() STEP 2.

Find the Integrated Circuit 555. Install it in the board with the notch, dot or band at one end in the right direction, as shown in the assembly diagram (holes: 17e, 18e, 19e, 20e, 17i, 18f, 19f, 20f).



() STEP 3.

Find and install the following resistors:
- 2.2K ohm (Red, Red, Red, Gold) from hole 17i to hole 18i.
- 100 ohm (Brown, Black, Brown, Gold) from hole 22i to hole 24i.
- 220 ohms (Red, Red, Brown, Gold) from hole 19d to hole 25c.



() STEP 4.

Find the photocell. Insert one lead into hole 18j and the other into hole 19j.



() STEP 5.

Find the .1µF (104) capacitor. Insert one lead into hole 17b and the other into hole 18c.



() STEP 6.

Find the speaker. Insert one of its leads into hole 24h and the other into hole 24d.



() STEP 7.

Find the 3904 transistor. Insert its leads into holes 24e, 25e and 26e. Be sure its flat side is pointing in the direction shown in the assembly diagram.



() STEP 8.

Get six wires. Install them as follows: one from 1j to 22h, one from 1h to 17h, one from 1c to 17a, one from 1a to 26a, one from 17g to 20d, and one from 18d to 19h.

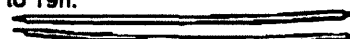

() STEP 9.

STOP! Before you test your project verify it against the Assembly Diagram, to be sure that all the components are installed in the right place. Also be sure that there are no short circuits on the board (wires or leads touching each other).



EKI

WAKE-UP ALARM

ASSEMBLY DIAGRAM

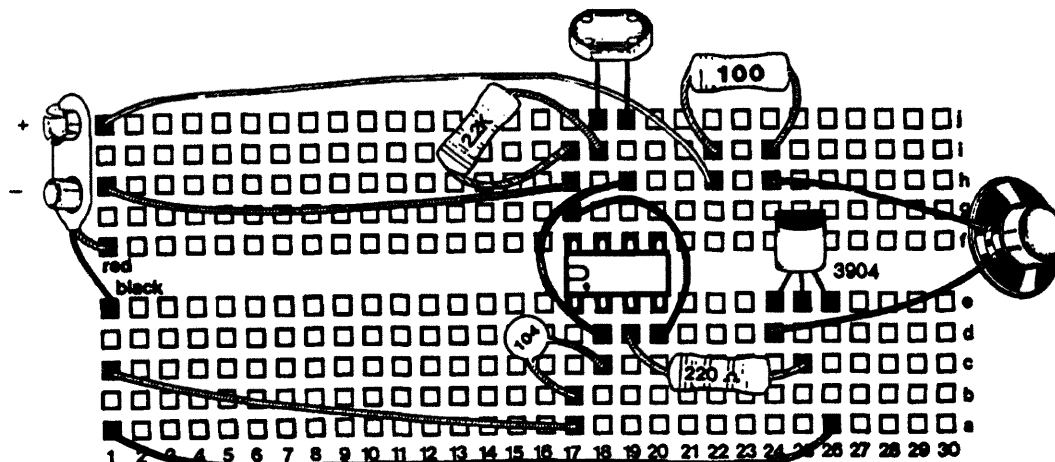

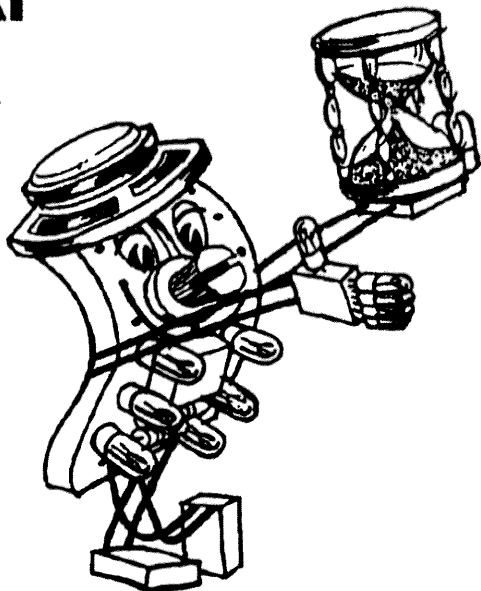

MicroCIRCUIT[®]

Solderless Electronic Kit

VARIABLE TIMER

LAB KIT A23

*** START HERE ***

(A) PURPOSE OF THIS PROJECT.

To build an useful variable timer circuit using the 555 IC Timer.

(B) CIRCUIT DESCRIPTION

A timer, as the term is used in digital electronics, is an electronic circuit that once triggered, produces an output pulse for a predetermined period and then shuts down.

A simple timer, for example, would involve momentarily pressing a button, to turn on a light, for a minute or so. After that time interval, the light is extinguished and the circuit is ready to be reactivated by a new press of the button. This is exactly what the variable timer does. With potentiometer R4 you can adjust the interval the LED remains ON.

To operate this project just connect the battery to the battery snap, adjust R4 to its middle position and press pushbutton S1 and observe the LED. Then, observe what happens when you readjust R4.

The circuit of the variable timer is made by a 555 working as a timer. The trigger of the timer occurs when a negative voltage is applied on pin 2 of the 555. The period of time the timer is ON, depends upon the values of R2, R4 and C1. To get longer periods of time, replace C1 with a 1000 μ F capacitor.

Now you are ready to assemble this project.

SCHMATIC DIAGRAM & PARTS LIST

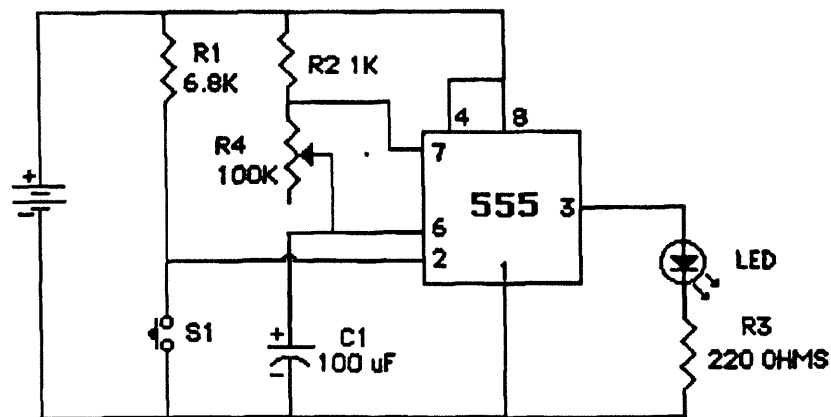

	Part #
- Battery Snap	SL35001
- R1: 6.8K ohm	SL01085
- R2: 1K ohm	SL01065
- R3: 220 ohm	SL01049
- R4: 100K ohm Pot.	SL33008
- S1: Pushbutton	SL25004
- C1: 100 μ F Cap.	SL05005
- 555 IC Timer	SL14004
- LED	SL06001



(C) Step By Step Assembly Instructions

VARIABLE TIMER / LAB KIT A23

GET THE SOLDERLESS CIRCUIT BOARD AND BUILD THE PROJECT ALWAYS COMPARING YOUR WORK TO THE ASSEMBLY DIAGRAM.

() STEP 1.

Find the Battery Snap. Insert the red wire into hole 1f, and the black wire into hole 1e.



() STEP 2.

Find the Integrated Circuit 555. Install it in the board with the notch, dot or band at one end in the right direction, as shown in the assembly diagram (holes: 20e, 21e, 22e, 23e, 20f, 21f, 22f, 23f).



() STEP 3.

Find and install the following resistors:
- 1K ohm (Brown, Black, Red, Gold) from hole 20h to hole 21i.
- 6.8K ohm (Blue, Gray, Red, Gold) from hole 11b to hole 21b.
- 220 ohms (Red, Red, Brown, Gold) from hole 22a to hole 29b.



() STEP 4.

Find the pushbutton switch. Insert one lead into hole 20c and the other into hole 21c.



() STEP 5.

Find the 100 μ F capacitor. Insert its positive lead (long lead) into hole 26f, and its negative lead (short lead) into hole 26e.

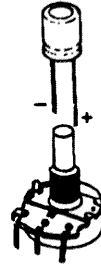

() STEP 6.

Find the potentiometer. Insert the center lead wire into hole 21h, and the left lead wire into hole 22i.

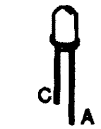

() STEP 7.

Find the red LED (light emitting diode). Insert its long lead into hole 29e, and its short lead into hole 30e.

() STEP 8.

Get six wires. Install them as follows: one from 1i to 20j, one from 1g to 11e, one from 1d to 20b, one from 1a to 26b, one from 20g to 23d, and one from 26a to 30b.



() STEP 9

STOP! Before you test your project verify it against the Assembly Diagram, to be sure that all the components are installed in the right place. Also be sure that there are no short circuits on the board (wires or leads touching each other).

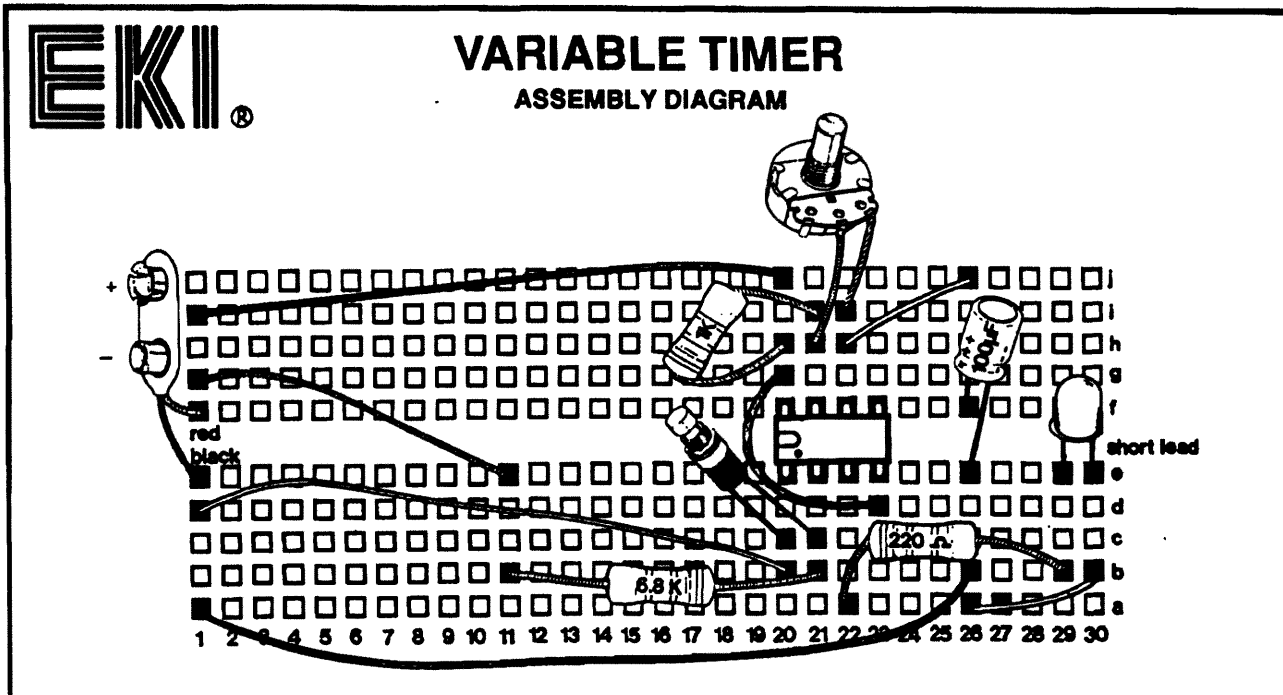
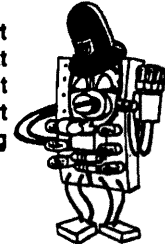

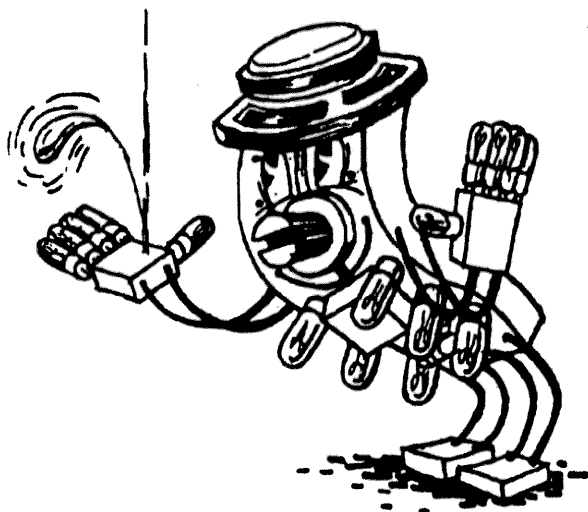

Mr. CIRCUIT[®]

Solderless Electronic Kit

MOISTURE DETECTOR

LAB KIT A24

*** START HERE ***

(A) PURPOSE OF THIS PROJECT.

To build an useful electronic project that detects the moisture in the earth.

(B) CIRCUIT DESCRIPTION

A moisture detector is a practical device that can be used to test the moisture in the earth around a plant, to be sure that it has the necessary water.

To operate it just connect a fresh 9-volt battery to the battery snap and then inject the probes (wires) into the earth around the plant. As you do that, the LED should start to blink at a rate proportional to the humidity of the soil. The more moisture, the faster the blinking, and viceversa. If there is no moisture at all,

the LED will not blink, remaining ON or OFF.

The circuit of the Moisture Detector is basically made of a 555 timer working as a clock, similar to the one explained in Mr. Circuit Lab Kit A11. The frequency of the pulses produced by the 555 is controlled by the resistance between the probes. The resistance between the probes depends upon the moisture that they detect. The more moisture, the lower the resistance, the faster the LED will blink.

Now you are ready to assemble this project.

SCHEMATIC DIAGRAM & PARTS LIST

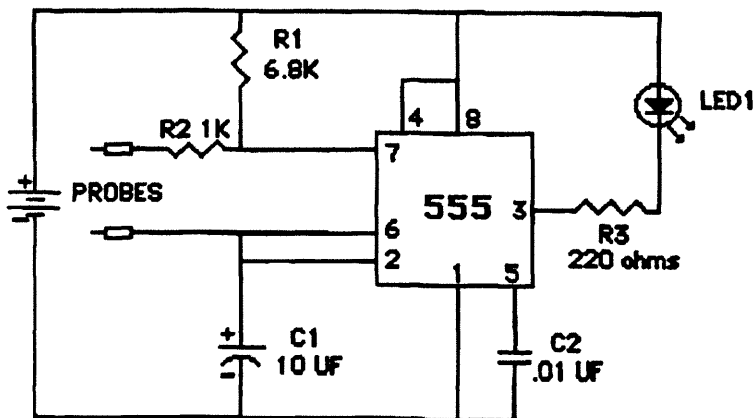

- | | |
|------------------|---------|
| - Battery Snap | Part # |
| - R1: 6.8K ohm | SL35001 |
| - R2: 1K ohm | SL01085 |
| - R3: 220 ohm. | SL01065 |
| - C1: 10 µF Cap. | SL01049 |
| - C2: .01 µF | SL05003 |
| - 555 IC Timer | SL02012 |
| - LED | SL14004 |
| | SL06001 |



(C) Step By Step Assembly Instructions

MOISTURE DETECTOR / LAB KIT A24

GET THE SOLDERLESS CIRCUIT BOARD AND BUILD THE PROJECT ALWAYS COMPARING YOUR WORK TO THE ASSEMBLY DIAGRAM.

() STEP 1.

Find the Battery Snap. Insert the red wire into hole 3f, and the black wire into hole 3e.



() STEP 2.

Find the Integrated Circuit 555. Install it in the board with the notch, dot or band at one end in the right direction, as shown in the assembly diagram (holes: 16e, 17e, 18e, 19e, 16f, 17f, 18f, 19f).



() STEP 3.

Find and install the following resistors:
- 1K ohm (Brown, Black, Red, Gold) from hole 8h to hole 17i.
- 6.8K ohm (Blue, Gray, Red, Gold) from hole 16j to hole 17j.
- 220 ohms (Red, Red, Brown, Gold) from hole 18d to hole 27c.



() STEP 4.

Find .01 μ F (103) capacitor. Insert one lead into hole 22f, and the other into hole 22e.



() STEP 5.

Find the red LED (light emitting diode). Insert its long lead into hole 27f, and its short lead into hole 27e.



() STEP 6.

Find the 10 μ F capacitor. Insert its positive lead (long lead) into hole 17b, and its short lead into hole 16c.



() STEP 7.

Get nine wires. Install seven wires as follows: one from 3j to 27h, one from 3i to 16i, one from 19h to 22h, one from 17d to 18h, one from 16g to 19d, one from 3c to 16b and one from 3b to 22a. Install one wire into hole 8j and another into hole 18j. Do not connect the other side of these wires. these two wires are the probes of the Moisture Detector.



() STEP 8.

STOP! Before you test your project verify it against the Assembly Diagram, to be sure that all the components are installed in the right place. Also be sure that there are no short circuits on the board (wires or leads touching each other).

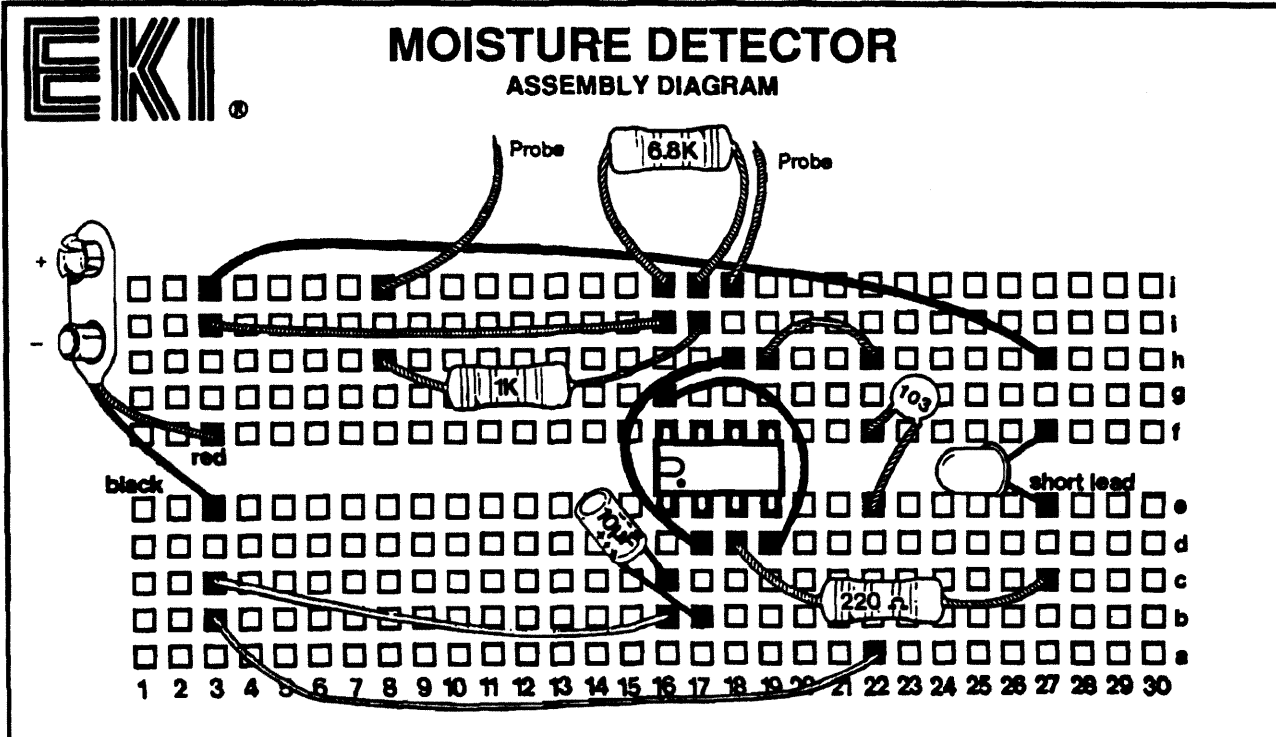

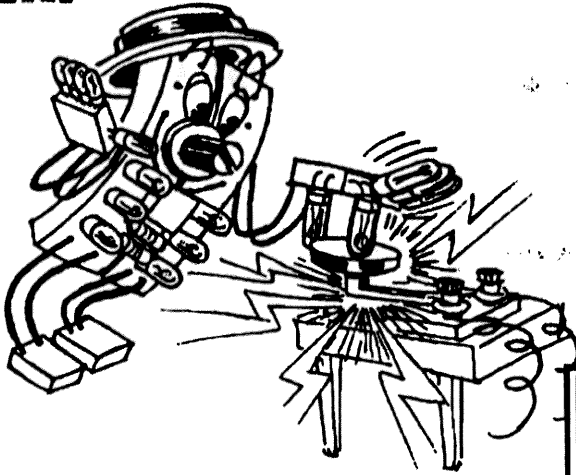

Mr. CIRCUIT[®]

Solderless Electronic Kit

CODE OSCILLATOR

*** START HERE ***

(A) PURPOSE OF THIS PROJECT.

LAB KIT A25

To build a useful Code Practice Oscillator.

(B) CIRCUIT DESCRIPTION

In this project you will build a Code Practice Oscillator that you can use to learn and practice the Morse Code. To operate this circuit, just connect a fresh 9-volt battery to the battery snap and use pushbutton S1 as the code key.

The circuit of the Code Oscillator is basically made by a 555 timer working as a clock, similar to the one explained in Mr. Circuit Lab Kit A11, which generates an audio signal each time pushbutton S1 is closed. Now you are ready to assemble this project.

A . - -	I . . .	Q - - -	Y - - - -	Z - - - .
B - - . .	J . - - -	R . - . .		
C - - . . .	K - - - .	S	NUMBERS	
D - - . .	L	T - - - .	1 . - - - -	6 - - . . .
E	M - - - .	U	2 . - - - -	7 - - . . .
F	N - - . .	V	3 . - - - -	8 - - . . .
G - - . . .	O - - - .	W	4 . - - - -	9 - - . . .
H	P - - . .	X - - . .	5 . - - - .	0 - - - - .

SCHEMATIC DIAGRAM & PARTS LIST

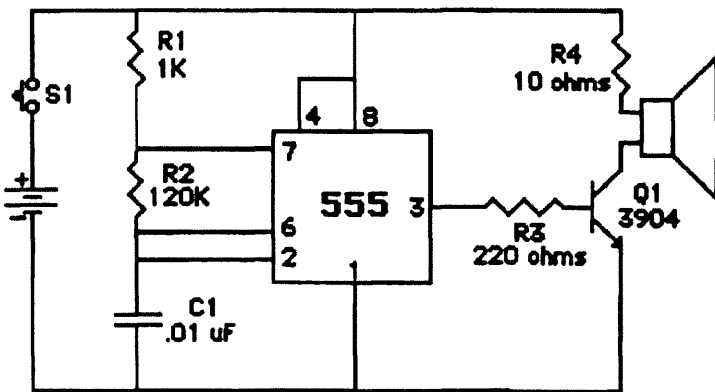

- | | |
|--------------------------|---------|
| - Battery Snap | Part # |
| - R1: 1K ohm | SL35001 |
| - R2: 120K ohm | SL01065 |
| - R3: 220 ohm | SL01115 |
| - R4: 10 ohm | SL01049 |
| - C1: .01µF Cap. | SL01017 |
| - 555 IC Timer | SL02012 |
| - Q1: 2N 3904 Transistor | SL14004 |
| - Speaker | SL18001 |
| | SL27001 |



Mr. Circuit Solderless Electronic Kit

(C) Step By Step Assembly Instructions

CODE OSCILLATOR / LAB KIT A25

GET THE SOLDERLESS CIRCUIT BOARD AND BUILD THE PROJECT ALWAYS COMPARING YOUR WORK TO THE ASSEMBLY DIAGRAM.

() STEP 1.

Find the Battery Snap. Insert the red wire into hole 4f, and the black wire into hole 2e.



() STEP 2.

Find the Integrated Circuit 555. Install it in the board with the notch, dot or band at one end in the right direction, as shown in the assembly diagram (holes: 16e, 17e, 18e, 19e, 16f, 17f, 18f, 19f).



() STEP 3.

Find and install the following resistors:
- 1Kohm (Brown, Black, Red, Gold) from hole 16i to hole 17i.
- 120K ohm (Brown, Red, Yellow, Gold) from hole 17j to hole 18j.
- 10 ohm (Brown, Black, Black, Gold) from hole 23j to hole 25i.
- 220 ohms (Red, Red, Brown, Gold) from hole 18c to hole 24c.



() STEP 4.

Find the pushbutton switch. Insert one lead into hole 2g and the other into hole 4g.



() STEP 5.

Find the .01µF (103) capacitor. Insert one lead into hole 18b and the other into hole 17c.



() STEP 6.

Find the speaker. Insert one of its leads into hole 25h and the other into hole 23d.



() STEP 7.

Find the 3904 transistor. Insert its leads into holes 23e, 24e and 25e. Be sure its flat side is pointing in the direction shown in the assembly diagram.

() STEP 8.

Get six wires. Install them as follows: one from 2j to 23i, one from 2i to 18j, one from 17d to 18h, one from 16g to 19d, one from 2b to 16a and one from 2a to 25a.



() STEP 9.

STOP! Before you test your project verify it against the Assembly Diagram, to be sure that all the components are installed in the right place. Also be sure that there are no short circuits on the board (wires or leads touching each other).



EKI

CODE OSCILLATOR

ASSEMBLY DIAGRAM

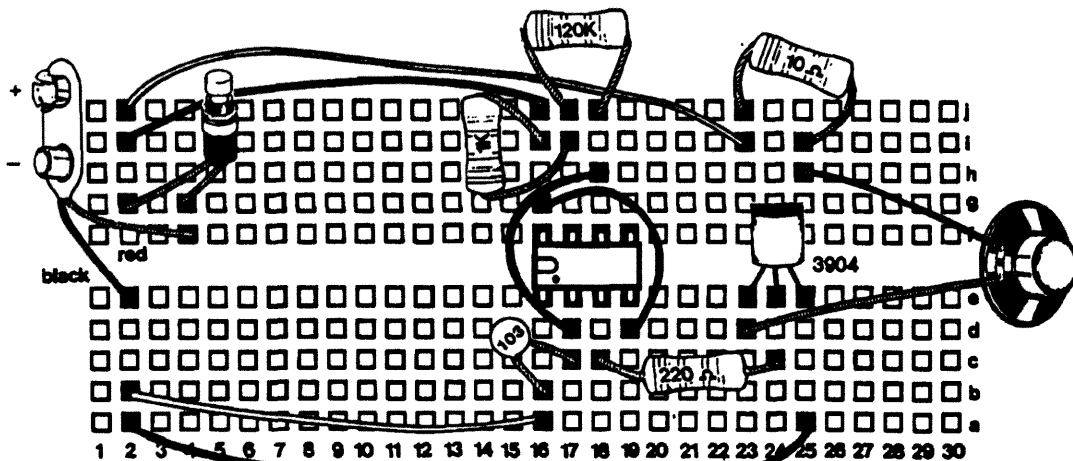

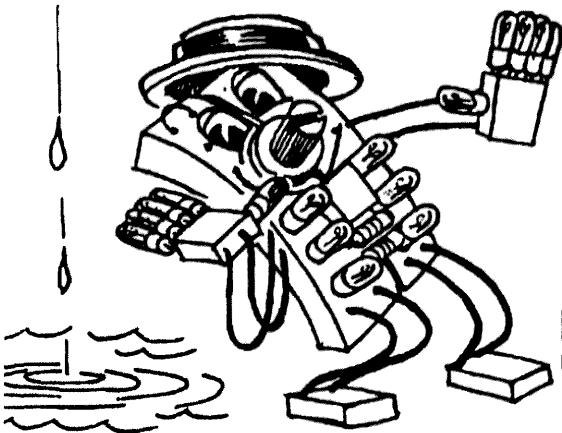

Mr. CIRCUIT[®]

Solderless Electronic Kit

AUDIBLE WATER DETECTOR

*** START HERE ***

(A) PURPOSE OF THIS PROJECT.

LAB KIT A26

To build a useful electronic project that can be used to monitor water levels.

(B) CIRCUIT DESCRIPTION

This useful project may be used to monitor water containers, such as bathtubs, sinks, swimming pools, etc., during filling to avoid overflow. When the water reaches the probes, this device will emit a loud sound. Signaling it is time to turn off the water.

To operate just connect a fresh 9-volt battery to the battery snap and install the probes in the water container. You can test your Audible Water Detector in a glass of water by touching the probes to the water. This should cause the speaker to sound.

The circuit of the Audible Water Detector is basically made of the 555 IC Timer working as a clock, similar to the one explained in Mr. Circuit Lab Kit A11.

When there is electrical continuity between the two probes (caused by the water). The 555 generates an audio signal which is amplified by transistor Q1 and then reproduced by the speaker.

Now you are ready to assemble this project.

SCHEMATIC DIAGRAM & PARTS LIST

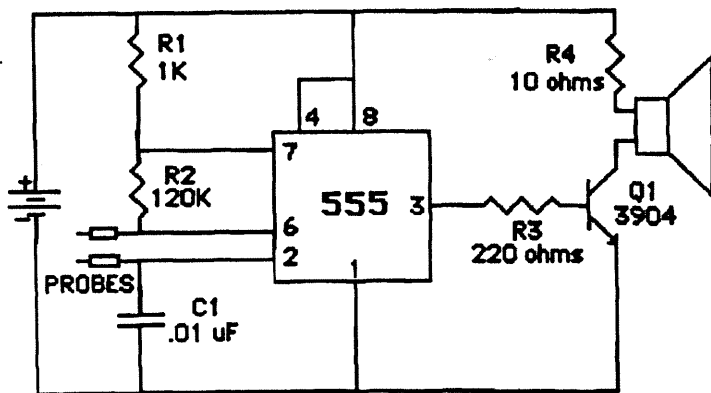

- | | Part # |
|--------------------------|---------|
| - Battery Snap | SL35001 |
| - R1: 1K ohm | SL01065 |
| - R2: 120K ohm | SL01115 |
| - R3: 220 ohm | SL01049 |
| - R4: 10 ohm | SL01017 |
| - C1: .01µF Cap. | SL02012 |
| - 555 IC Timer | SL14004 |
| - Q1: 2N 3904 Transistor | SL18001 |
| - Speaker | SL27001 |



Mr. Circuit Solderless Electronic Kit

(C) Step By Step Assembly Instructions

AUDIBLE WATER DETECTOR / LAB KIT A26

GET THE SOLDERLESS CIRCUIT BOARD AND BUILD THE PROJECT ALWAYS COMPARING YOUR WORK TO THE ASSEMBLY DIAGRAM.

() **STEP 1.**

Find the Battery Snap. Insert the red wire into hole 1f, and the black wire into hole 1e.



() **STEP 2.**

Find the Integrated Circuit 555. Install it in the board with the notch, dot or band at one end in the right direction, as shown in the assembly diagram (holes: 17e, 18e, 19e, 20e, 17f, 18f, 19f, 20f).



() **STEP 3.**

Find the 1K ohm resistor (Brown, Black, Red, Gold). Insert one lead into hole 17i, and the other into hole 18i.



() **STEP 4.**

Find the 120K ohm resistor (Brown, Red, Yellow, Gold). Insert one lead into hole 18j, and the other into hole 19j.



() **STEP 5.**

Find and install the following resistors:
- 10 ohm (Brown, Black, Black, Gold) from hole 22j to 24j.
- 220 ohms (Red, Red, Brown, Gold) from hole 19d to 25c.



() **STEP 6.**

Find the .01µF (103) capacitor. Insert one lead into hole 17d and the other into hole 18c.



() **STEP 7.**

Find the 3904 transistor. Insert its leads into holes 24e, 25e and 26e. Be sure its flat side is pointing in the direction shown in the assembly diagram.



() **STEP 8.**

Find the speaker. Insert one of its leads into hole 24i and the other into hole 24d.



() **STEP 9.**

Get seven wires. Install five wires as follows: one from 1h to 22i, one from 1g to 17h, one from 1c to 17b, one from 1a to 26a, and one from 17g to 20d.

Install one wire into hole 19h and another wire into hole 18d. Do not connect the other side of these wires. These two wires are the probes of the Water Detector.



() **STEP 10.**

STOP! Before you test your project verify it against the Assembly Diagram, to be sure that all the components are installed in the right place. Also be sure that there are no short circuits on the board (wires or leads touching each other).

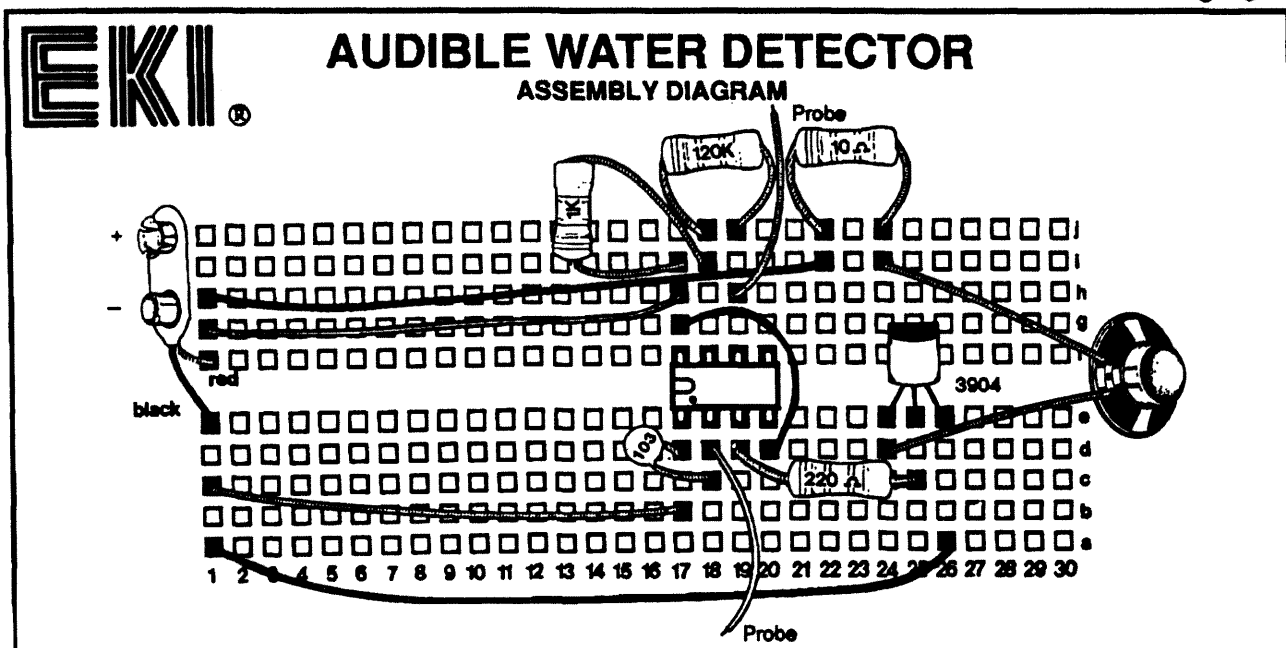

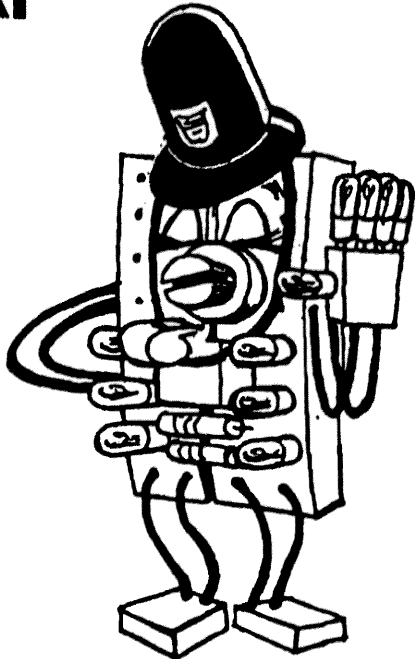

Mr. CIRCUIT[®]

Solderless Electronic Kit

ENGLISH POLICE SIREN

LAB KIT A27

*** START HERE ***

(A) PURPOSE OF THIS PROJECT.

To build a fun and useful electronic project that generates a two-tone siren.

(B) CIRCUIT DESCRIPTION

This amazing project will generate the typical sound of the two-tone siren used by the British Police. To operate it, just connect a fresh 9-volt battery to the battery snap and then alternately press and release pushbutton S1.

The circuit of the English Police Siren is basically made by a 555 IC working as a clock, as explained in Mr. Circuit Lab Kit A11.

When switch S1 is open, the frequency of the audio signal generated by the IC depends upon the values R1, R2 and C1. Under these circumstances a tone is generated. When the pushbutton S1 is pressed, R5 is set in parallel with R2. The parallel R2-R5 will have a different resistance value than the one of R2, and therefore, the frequency of the audio signal changes and the second tone is generated.

Now you are ready to assemble this project.

SCHEMATIC DIAGRAM & PARTS LIST

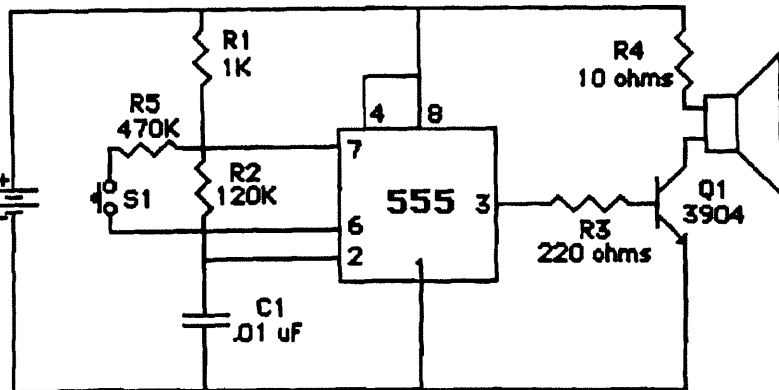

	Part #
- Battery Snap	SL35001
- R1: 1K ohm'	SL01065
- R2: 120K ohm	SL01115
- R3: 220 ohm	SL01049
- R4: 10 ohm	SL01017
- R5: 470K ohm	SL01129
- C1: .01µF Cap.	SL02012
- 555 IC Timer	SL14004
- Q1: 2N 3904 Transistor	SL18001
- Speaker	SL27001
- S1: Pushbutton	SL25004



Mr. Circuit Solderless Electronic Kit

(C) Step By Step Assembly Instructions

ENGLISH POLICE SIREN / LAB KIT A27

GET THE SOLDERLESS CIRCUIT BOARD AND BUILD THE PROJECT ALWAYS COMPARING YOUR WORK TO THE ASSEMBLY DIAGRAM.

() **STEP 1.**

Find the Battery Snap. Insert the red wire into hole 1f, and the black wire into hole 1e.



() **STEP 2.**

Find the Integrated Circuit 555. Install it in the board with the notch, dot or band at one end in the right direction, as shown in the assembly diagram (holes: 15e, 16e, 17e, 18e, 15f, 16f, 17f, 18f).



() **STEP 3.**

Find and install the following resistors:
- 1K ohm (Brown, Black, Red, Gold) from hole 15i to 16j.
- 470K ohm (Yellow, Violet, Yellow, Gold) from hole 8h to 16h.
- 120K ohm (Brown, Red, Yellow, Gold) from hole 16i to 17i.
- 220 ohms (Red, Red, Brown, Gold) from hole 17c to 26c.
- 10 ohms (Brown, Black, Black, Gold) from 24j to 26j.



() **STEP 4.**

Find the pushbutton switch. Insert one lead into hole 8f and the other into hole 8e.



() **STEP 5.**

Find the .01µF (103) capacitor. Insert one lead into hole 15b and the other into hole 16b.



() **STEP 6.**

Find the speaker. Insert one of its leads into hole 25d and the other into hole 26i.



() **STEP 7.**

Find the 3904 transistor. Insert its leads into holes 25e, 26e and 27e. Be sure its flat side is pointing in the direction shown in the assembly diagram.



() **STEP 8.**

Get seven wires. Install them as follows: one from 1j to 24h, one from 1h to 15h, one from 1b to 15a, one from 1a to 27a, one from 16d to 17h, one from 15g to 18d, and one from 8d to 16c.

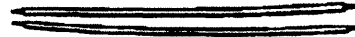

() **STEP 9**

STOP! Before you test your project verify it against the Assembly Diagram, to be sure that all the components are installed in the right place. Also be sure that there are no short circuits on the board (wires or leads touching each other).

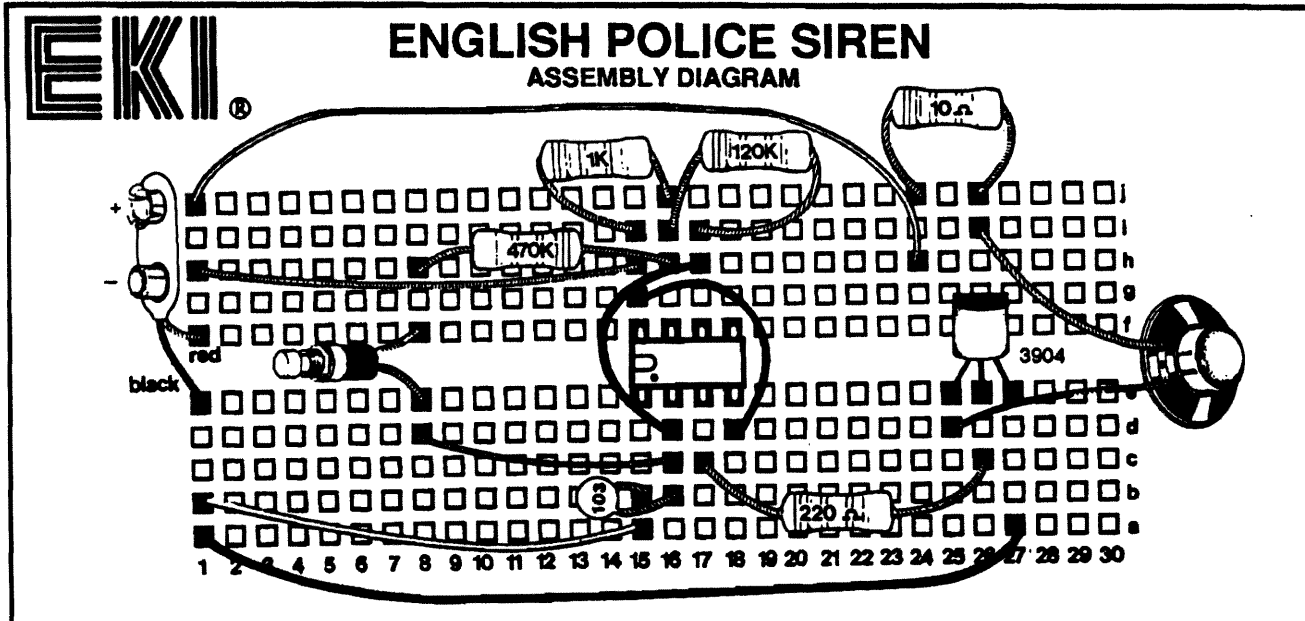

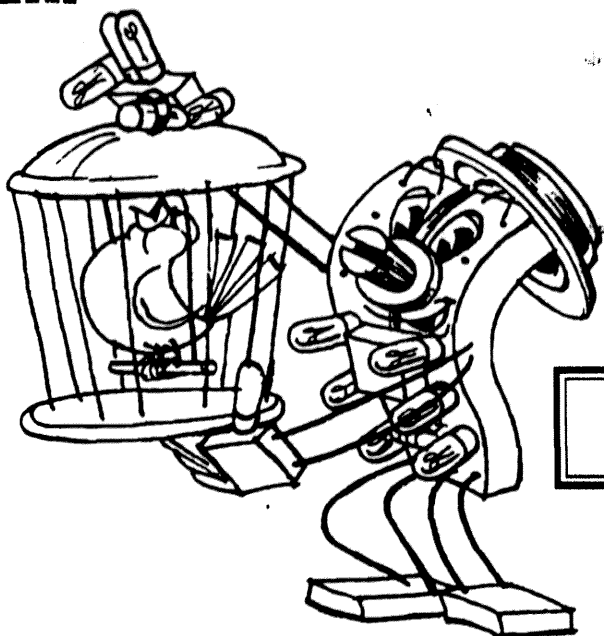

Mr. CIRCUIT[®]

Solderless Electronic Kit

ELECTRONIC CANARY

LAB KIT A28

*** START HERE ***

(A) PURPOSE OF THIS PROJECT.

To build a fun electronic project that generates a sound similar to the singing of a canary.

(B) CIRCUIT DESCRIPTION

Do you have a canary at home? If you don't, here is the solution. This amazing Electronic Canary does not consume any food, just a few electrons, and sings like a real canary.

To operate it, just connect a fresh 9-volt battery to the battery snap, press pushbutton S1, and adjust potentiometer R7 until you get the desired canary sound. To get more real bird sound effects, press and release S1 intermittently while adjusting R7.

The circuit of the Electronic Canary is made of two oscillators in series. The first is a two transistor audio oscillator consisting of Q1 and Q2, as the one explained in Mr. Circuit Lab Kit A10. The audio signal generated by the first oscillator is "injected" in pin 5 of the 555 IC, to control the frequency of its audio signal. The result of this process is an audio signal present on pin 3 of the 555 which is constantly changing its frequency. When this signal is reproduced by the speaker the result is a sound similar to a bird singing.

Now you are ready to assemble this project.

SCHMATIC DIAGRAM & PARTS LIST

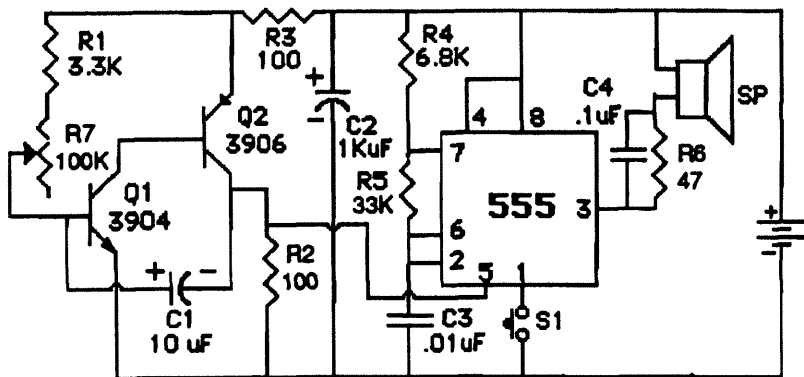

	Part #
- Battery Snap	SL35001
- R1: 3.3K ohm	SL01077
- R2: 100 ohm	SL01041
- R3: 100 ohm	SL01041
- R4: 6.8 K ohm	SL01085
- R5: 33K ohm	SL01101
- R6: 47 ohm	SL01033
- R7: 100K ohm Pot.	SL33008
- C1: 10 μ F Cap.	SL05003
- C2: 1000 μ F Cap.	SL05009
- C3: .01 μ F Cap.	SL02012
- C4: .1 μ F Cap.	SL02016
- Q1: 2N3904 Transistor	SL18001
- Q2: 2N3906 Transistor	SL18002
- 555 IC Timer	SL14004
- S1: N/O Pushbutton	SL25004
- Speaker	SL27001



Mr. Circuit Solderless Electronic Kit

(C) Step By Step Assembly Instructions

ELECTRONIC CANARY / LAB KIT A28

GET THE SOLDERLESS CIRCUIT BOARD AND BUILD THE PROJECT ALWAYS COMPARING YOUR WORK TO THE ASSEMBLY DIAGRAM.

() STEP 1.

Find the Battery Snap. Insert the red wire into hole 1d, and the black wire into hole 1f.



() STEP 2.

Find the Integrated Circuit 555. Install it in the board with the notch, dot or band at one end in the right direction, as shown in the assembly diagram (holes: 13e, 14e, 15e, 16e, 13f, 14f, 15f, 16f).



() STEP 3.

Find and install the following resistors:

- 100 ohm (Brown, Black, Brown, Gold) from hole 1a to hole 3a.
- 47 ohm (Yellow, Violet, Black, Gold) from hole 10h to hole 14h.
- 33K ohm (Orange, Orange, Orange, Gold) from hole 14b to hole 15b.
- 6.8K ohms (Blue, Gray, Red, Gold) from hole 15a to hole 16b.
- 100 ohm (Brown, Black, Brown, Gold) from 21c to hole 26c.
- 3.3K ohms (Orange, Orange, Red, Gold) from 24b to hole 29b.



() STEP 4.

Find the pushbutton switch. Insert one lead into hole 16j and the other into hole 19j.



() STEP 5.

Find the potentiometer. Insert the center lead wire into hole 29c, and the right lead wire into hole 28g.



() STEP 6.

Find the .01µF (103) and the .1 µF (104) capacitors. Insert 103 into holes 15h and 19h, and 104 into holes 10i and 14i.



() STEP 7.

Find the 1000 µF and 10 µF capacitors. Install them as follows:

- 1000 µF: long lead (+) to 1c, short lead (-) to 1i.
- 10µF: long lead (+) to 26f, short lead (-) to 28e



() STEP 8.

Find the speaker. Insert one of its leads into hole 1e and the other into hole 10g.



() STEP 9.

Find the 3904 and the 3906 transistors. Insert the 3904 into holes 25h, 26h and 27h, and the 3906 into 24d, 25d and 26d. Be sure the flat side of the transistors is pointing in the direction shown in the assembly diagram.



() STEP 10.

Get nine wires. Install them as follows: one from 1j to 27j, one from 13g to 16d, one from 14d to 15g, one from 19f to 21e, one from 21d to 27i, one from 25f to 25e, one from 13d to 26a, one from 3b to 24a, and one from 1b to 16a.



() STEP 11

STOP! Before you test your project verify it against the Assembly Diagram, to be sure that all the components are installed in the right place. Also be sure that there are no short circuits on the board (wires or leads touching each other).

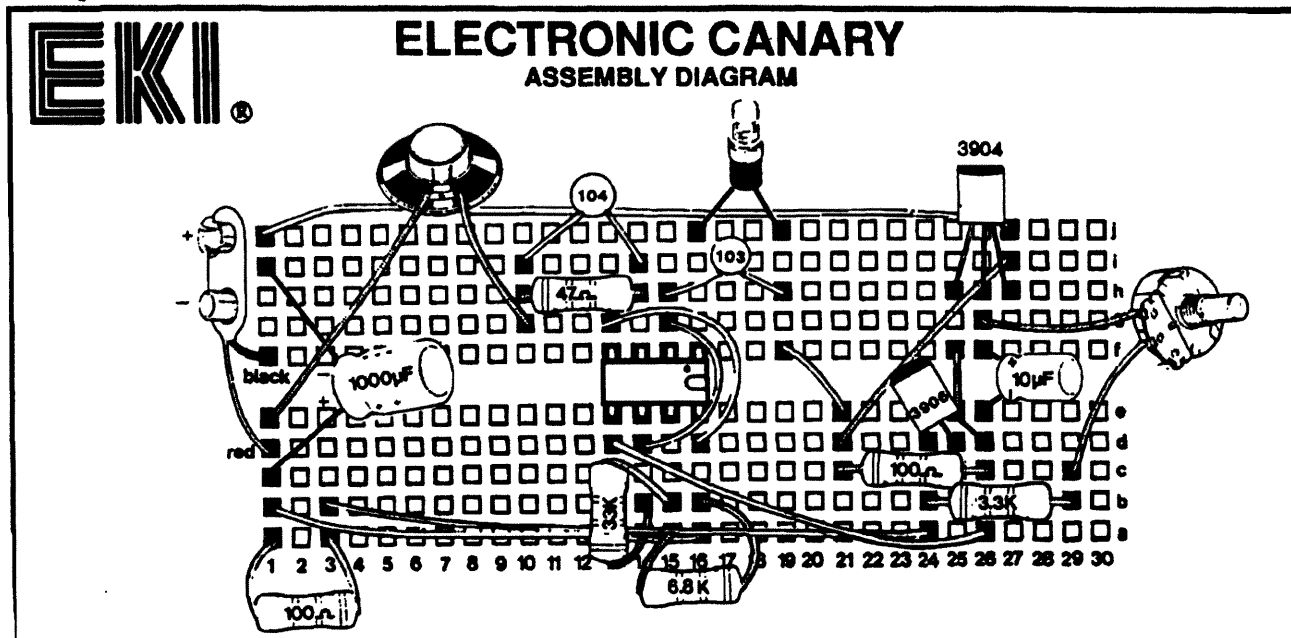

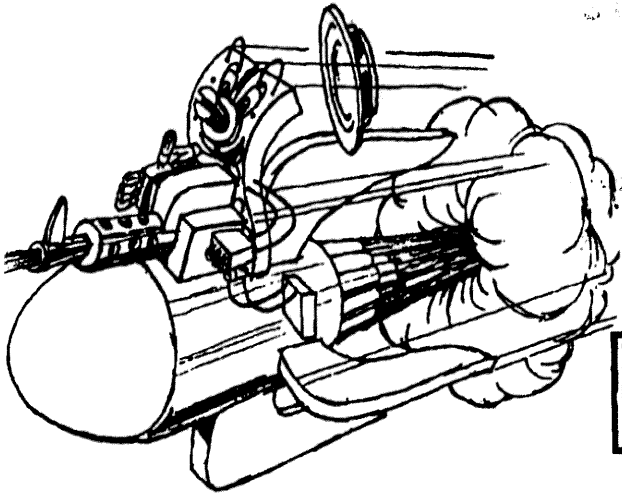

Mr. CIRCUIT[®]

Solderless Electronic Kit

SPACE MACHINE GUN

LAB KIT A29

*** START HERE ***

(A) PURPOSE OF THIS PROJECT.

To build a fun electronic project that generates a sound similar to a space machine gun.

(B) CIRCUIT DESCRIPTION

The Space Machine Gun is a fun project that generates the sound of a Phaser Gun like those produced in Space Arcade Games. It also produces a light effect which follows the firing. The firing rate of the "machine gun" can be adjusted with potentiometer R7.

To operate it, just connect a fresh 9-volt battery to the

battery snap and press the "gun trigger", which is pushbutton S1.

Adjust R7 to control the firing rate.

The circuit of the Space Machine Gun has two oscillators, one controlling the frequency of the other, like that as explained in Mr. Circuit Lab Kit A29.

Now you are ready to assemble this project.

SCHEMATIC DIAGRAM & PARTS LIST

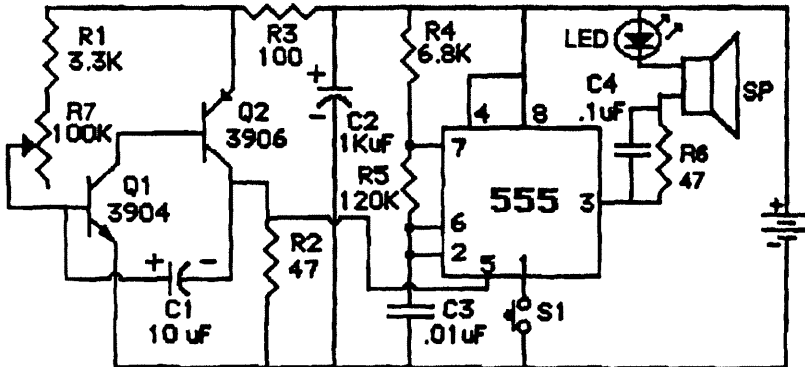

- | | |
|-------------------------|-------------------|
| - Battery Snap | Part #
SL35001 |
| - R1: 3.3K ohm | SL01077 |
| - R2: 47 ohm | SL01033 |
| - R3: 100 ohm | SL01041 |
| - R4: 6.8 K ohm | SL01085 |
| - R5: 120K ohm | SL01115 |
| - R6: 47 ohm | SL01033 |
| - R7: 100K ohm Pot. | SL33008 |
| - C1: 10 μ F Cap. | SL05003 |
| - C2: 1000 μ F Cap. | SL05009 |
| - C3: .01 μ F Cap. | SL02012 |
| - C4: .1 μ F Cap. | SL02016 |
| - Q1: 2N3904 Transistor | SL18001 |
| - Q2: 2N3906 Transistor | SL18002 |
| - 555 IC Timer | SL14004 |
| - LED | SL08001 |
| - Speaker | SL27001 |



(C) Step-By-Step Assembly Instructions

SPACE MACHINE GUN / LAB KIT A29

GET THE SOLDERLESS CIRCUIT BOARD AND BUILD THE PROJECT ALWAYS COMPARING YOUR WORK TO THE ASSEMBLY DIAGRAM.

() **STEP 1.**

Find the Battery Snap. Insert the red wire into hole 1e, and the black wire into hole 1f.



() **STEP 2.**

Find the Integrated Circuit 555. Install it in the board with the notch, dot or band at one end in the right direction, as shown in the assembly diagram (holes: 13e, 14e, 15e, 16e, 13f, 14f, 15f, 16f).



() **STEP 3.**

Find and install the following resistors:

- 100 ohm (Brown, Black, Brown, Gold) from hole 1a to hole 3a.
- 47 ohm (Yellow, Violet, Black, Gold) from hole 9i to hole 14i.
- 120K ohm (Brown, Red, Yellow, Gold) from hole 14b to hole 15b.
- 6.8K ohms (Blue, Gray, Red, Gold) from hole 15a to hole 16b.
- 47 ohm (Yellow, Violet, Black, Gold) from 21c to hole 26c.
- 3.3K ohms (Orange, Orange, Red, Gold) from 24b to hole 29b.



() **STEP 4.**

Find the pushbutton switch. Insert one lead into hole 16i and the other into hole 19i.



() **STEP 5.**

Find the potentiometer. Insert the center lead wire into hole 26g, and the right lead wire into hole 29c.



() **STEP 6.**

Find the .01µF (103) and the .1 µF (104) capacitors. Insert 103 into holes 15h and 19h, and 104 into holes 9h and 14h.



() **STEP 7.**

Find the 1000 µF and 10 µF capacitors. Install them as follows:

- 1000 µF: long lead (+) to 1b, short lead (-) to 1i.
- 10µF: long lead (+) to 26f, short lead (-) to 26e



() **STEP 8.**

Find the speaker. Insert one of its leads into hole 1d and the other into hole 8f.



() **STEP 9.**

Find the 3904 and the 3906 transistors. Insert the 3904 into holes 25h, 28h and 27h, and the 3906 into 24d, 25d and 26d. Be sure the flat side of the transistors is pointing in the direction shown in the assembly diagram.



() **STEP 10.**

Find the red LED (light emitting diode). Insert its long lead into hole 8g, and its short lead into hole 9g.



() **STEP 11.**

Get nine wires. Install them as follows: one from 1j to 27j, one from 13g to 16d, one from 14d to 15g, one from 19j to 21e, one from 21d to 27i, one from 25g to 25e, one from 13c to 28a, one from 3b to 24a, and one from 1c to 18a.

() **STEP 12**

STOP! Before you test your project verify it against the Assembly Diagram, to be sure that all the components are installed in the right place. Also be sure that there are no short circuits on the board (wires or leads touching each other).

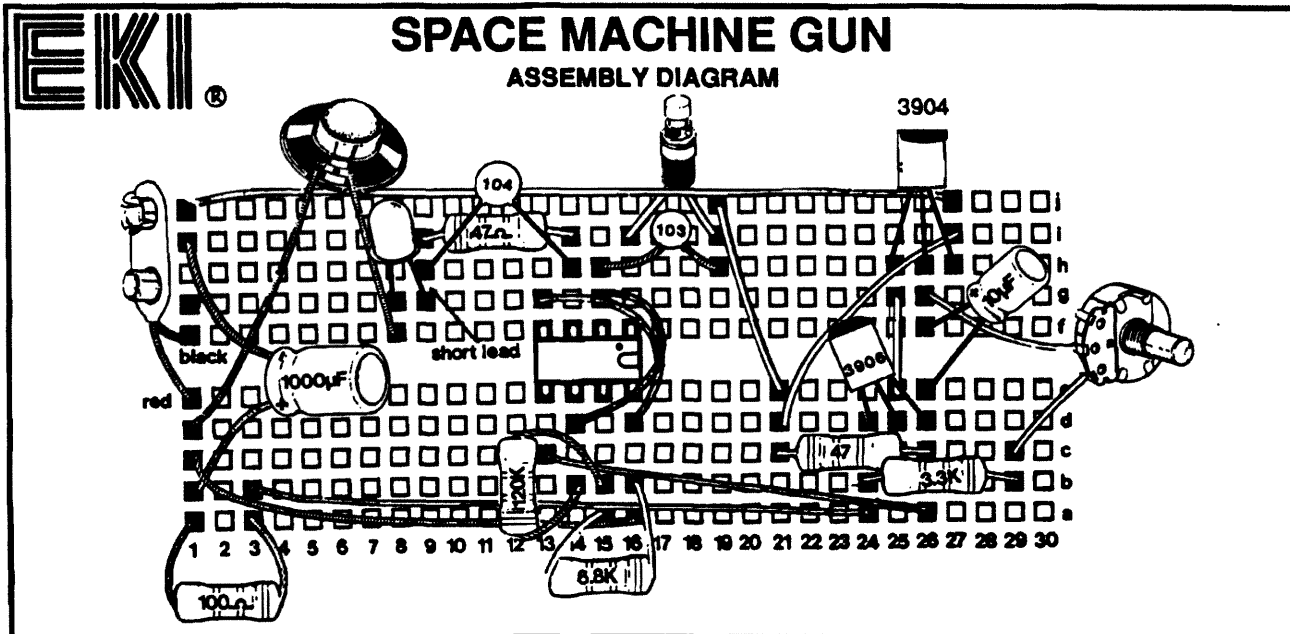



Mr. CIRCUIT[®]

Solderless Electronic Kit

ULTRASONIC PEST REPELLER

LAB KIT A30

*** START HERE ***

(A) PURPOSE OF THIS PROJECT.

To build a fun and useful electronic project that generates ultrasonic sound.

(B) CIRCUIT DESCRIPTION

Do you have pests in your home? ... like roaches, crickets, etc. If you do, try this Ultrasonic Pest Repeller.

It has been proven that certain frequencies of ultrasonic sounds (sounds not perceived by humans) irritate certain kinds of bugs like roaches, crickets, etc., causing them to flee.

This project constantly generates a series of ultrasonic sounds from 13.5 KHz to 80 KHz. Because of this, it has a wide spectrum of action which may cause pests to flee away.

To operate this project, just connect a fresh 9-volt battery to the battery snap and you are in business. Now you are ready to assemble this project.

SCHEMATIC DIAGRAM & PARTS LIST

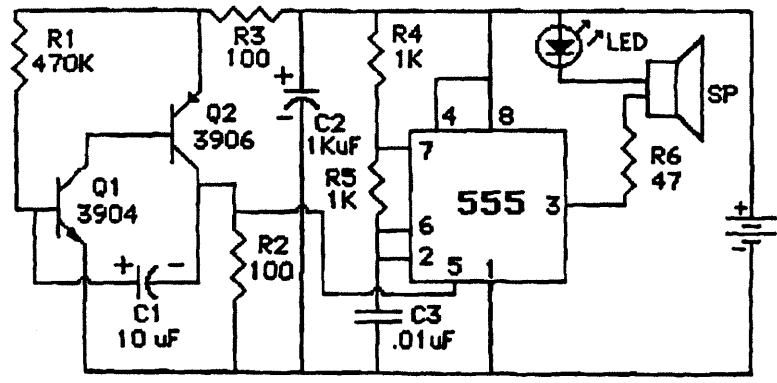

- | | |
|-------------------------|---------|
| - Battery Snap | SL35001 |
| - R1: 470K ohm | SL01129 |
| - R2: 100 ohm | SL01041 |
| - R3: 100 ohm | SL01041 |
| - R4: 1 K ohm | SL01085 |
| - R5: 1K ohm | SL01085 |
| - R6: 47 ohm | SL01033 |
| - C1: 10 μ F Cap. | SL05003 |
| - C2: 1000 μ F Cap. | SL05009 |
| - C3: .01 μ F Cap. | SL02012 |
| - Q1: 2N3904 Transistor | SL18001 |
| - Q2: 2N3906 Transistor | SL18002 |
| - 555 IC Timer | SL14004 |
| - LED | SL06001 |
| - Speaker | SL27001 |



Mr. Circuit Solderless Electronic Kit

(C) Step-By-Step Assembly Instructions

ULTRASONIC PEST REPELLER / LAB KIT A30

GET THE SOLDERLESS CIRCUIT BOARD AND BUILD THE PROJECT ALWAYS COMPARING YOUR WORK TO THE ASSEMBLY DIAGRAM.

() STEP 1.

Find the Battery Snap. Insert the red wire into hole 1e, and the black wire into hole 1f.



() STEP 2.

Find the Integrated Circuit 555. Install it in the board with the notch, dot or band at one end in the right direction, as shown in the assembly diagram (holes: 14e, 15e, 16e, 17e, 14f, 15f, 16f, 17f).



() STEP 3.

Find and install the following resistors:

- 100 ohm (Brown, Black, Brown, Gold) from hole 1a to hole 3a.
- 47 ohm (Yellow, Violet, Black, Gold) from hole 10h to hole 15h.
- 1K ohm (Brown, Black, Red, Gold) from hole 15b to hole 16b.
- 1Kohms (Brown, Black, Red, Gold) from hole 16a to hole 17b.
- 100 ohm (Brown, Black, Brown, Gold) from hole 21c to hole 26c.
- 470K ohms (Yellow, Violet, Yellow, Gold) from hole 24b to hole 29b.



() STEP 4.

Find the .01µF (103) capacitor. Insert one lead into hole 16i, and the other into hole 17i.



() STEP 5.

Find the 1000 µF and 10 µF capacitors. Install them as follows:

- 1000 µF: long lead (+) to 1c, short lead (-) to 1i.
- 10µF: long lead (+) to 29c, short lead (-) to 28e



() STEP 6.

Find the speaker. Insert one of its leads into hole 9e and the other into hole 10i.



() STEP 7.

Find the 3904 and the 3906 transistors. Insert the 3904 into holes 25h, 26h and 27h, and the 3906 into 24d, 25d and 26d. Be sure the flat side of the transistors are pointing in the direction shown in the assembly diagram.



() STEP 8.

Find the red LED (light emitting diode). Insert its long lead into hole 8b, and its short lead into hole 9b.



() STEP 9.

Get eleven wires. Install them as follows: one from 1j to 27j, one from 17j to 21d, one from 21e to 27i, one from 25f to 25e, one from 26f to 29d, one from 14c to 26a, one from 1d to 8c, one from 1b to 17a, one from 3b to 24a, one from 14g to 17d, and one from 15d to 16g.



() STEP 10

STOP! Before you test your project verify it against the Assembly Diagram, to be sure that all the components are installed in the right place. Also be sure that there are no short circuits on the board (wires or leads touching each other).



ULTRASONIC PEST REPELLER

ASSEMBLY DIAGRAM

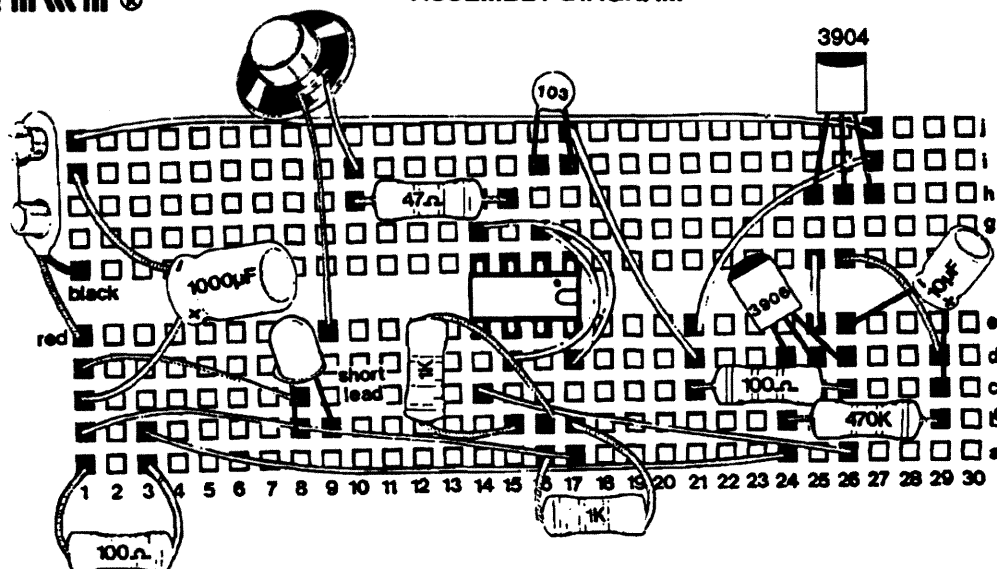

REPLACEMENT PARTS / ORDER FORM

Oct.1993

EKI SCIENCE ELECTRONIC LAB

QTY.	DESCRIPTION	PART #	PRICE	TOTAL
	SPEAKER	SL27001	1.49	
	10 Ω Resistor	SL01017	0.10	
	47 Ω Resistor	SL01033	0.10	
	100 Ω Resistor	SL01041	0.10	
	220 Ω Resistor	SL01049	0.10	
	1 KΩ Resistor	SL01065	0.10	
	2.2 KΩ Resistor	SL01073	0.10	
	3.3 KΩ Resistor	SL01077	0.10	
	6.8 KΩ Resistor	SL01085	0.10	
	16 KΩ Resistor	SL01094	0.10	
	33 KΩ Resistor	SL01101	0.10	
	120 KΩ Resistor	SL01115	0.10	
	470 KΩ Resistor	SL01129	0.10	
	1000 μF Capacitor	SL05009	0.55	
	100 μF Capacitor	SL05005	0.35	
	10 μF Capacitor	SL05003	0.25	
	.1 μF Capacitor	SL02016	0.25	
	.01 μF Capacitor	SL02012	0.15	
	100KΩ Potentiometer	SL33008	1.25	
	SCR	SL13001	1.00	
	Power Diode	SL30001	0.15	
	LED	SL06001	0.20	
	Photocell	SL45028	1.25	
	Battery Snap	SL35001	0.25	
	4 Inch Wire	SL45011	0.05	
	IC 555	SL14004	0.95	
	N/O Pushbutton	SL25004	0.85	
	Transistor NPN	SL18001	0.39	
	Transistor PNP	SL18002	0.39	
	Complete Set (all above)	SL 1102	8.95	
	Experiment Manual	SL 1181	11.95	
	Solderless C.B.	SL16002	6.95	
	Complete Lab	1101	21.90	

Date of Order: _____	Ship to: _____	TOTAL ORDER	
School: _____	Address: _____	Shipping 5%	
City: _____	State: _____ Zip: _____	CA Tax 7.75%	
Telephone: _____		TOTAL	
Purchase Order #: _____	Purchaser: _____		
Method of Payment: <input type="checkbox"/> Check, <input type="checkbox"/> Money Order, <input type="checkbox"/> VISA, <input type="checkbox"/> MC.			
Charge Number: _____ Exp. Date: _____			

EKI 16631 Noyes Ave., Irvine CA 92714 / 1-800-453-1708 or (714) 833-8711

MC. RPOF/10/93