44 in 1 Communications Exploration Kit

Copyright ©1997-2009
Chaney Electronics Inc.
Scottsdale, Arizona

Table of Contents
Communications and Opto-Electronics Lab

44 in 1 Communications Exploration Kit

Copyright ©1997-2009

Chaney Electronics Inc.
Scottsdale, Arizona

Table of Contents

Communications and Opto-Electronics Lab

<i>Introduction</i>	5
<i>Parts Inventory</i>	6-9
<i>Preactivity</i>	10-13
<i>Lesson 1: Electronic Communication</i>	14,15
Experiment 1: Morse Code Generator	16,17
Experiment 2: 1-wire Telegraph System.....	18,19
Experiment 3: 2-wires PA System	20, 21
Experiment 4: Coaxial Cable PA System.....	22, 23
<i>Lesson 2: Alternating Current (AC) Characteristics</i>	24-26
<i>Lesson 3: Radio Communication & Electromagnetic Waves</i>	27, 28
<i>Lesson 4: Frequency Spectrum</i>	29
<i>Lesson 5: Wireless Lightwave Communication</i>	30, 31
Experiment 5: Opto Receiver.....	32, 33
Experiment 6: Opto Transmitter	34, 35
Experiment 7: Infrared Opto Transmitter	36, 37
Experiment 8: Opto Voice Transmitter	38, 39
Experiment 9: Infrared Opto Voice Transmitter	40, 41
Experiment 10: Opto Music Transmitter	42, 43
Experiment 11: Infrared Opto Music Transmitter.....	44, 45
<i>Lesson 6: Fiber Optics Communication</i>	46
Experiment 12: Introduction to Fiber Optics	47
Experiment 13: Fiber Optics - Dual Color Transmission	48
Experiment 14: Fiber Optics - Multiple Fiber Transmission	49
Experiment 15: Fiber Optic Audio Link	50, 51
Experiment 16: Infrared Fiber Optic Audio Link	52, 53
Experiment 17: Infrared Remote Control Receiver	54
Experiment 18: Infrared Remote Control Transmitter.....	55
Experiment 19: Audible Infrared Remote Control Receiver	56
Experiment 20: Infrared Proximity Detector	57
Experiment 21: Audible Infrared Proximity Detector	58, 59
Experiment 22: Infrared On/Off Remote Control Switch.....	60, 61
Experiment 23: Simple Infrared Transmitter	62
<i>Lesson 7: Radio Communication</i>	63-66
Experiment 24: Crystal Radio Receiver	67
Experiment 25: Basic AM Receiver	68, 69
Experiment 26: AM Radio Receiver with Speaker.....	70, 71
Experiment 27: AM Radio Receiver with Speaker and Volume Control	72, 73
Experiment 28: AM Tone Transmitter	74, 75
Experiment 29: AM Code Transmitter.....	76, 77
Experiment 30: AM Broadcast Station	78, 79
Experiment 31: AM Microphone Transmitter.....	80, 81
Experiment 32: FM Tone Transmitter.....	82, 83
Experiment 33: FM Code Transmitter	84, 85
Experiment 34: FM Microphone Transmitter	86, 87
Replacement Parts Order Form.....	88

Communication & Opto Electronics Deluxe Exploration Kit

Introduction

Objective:

The objective of this lab is to introduce students to electronic communication and opto electronics in a meaningful and exciting way. This lab was created with the student in mind. Throughout this lab we have used the proven method of "learning by doing". This lab will keep the hands and minds of the students busy, building amazing communication experiments by using wire, fiber optics, radio waves, light and infrared links. The students will learn communication and opto electronics by building real working circuits and experimenting with them.

Prerequisites:

Even though no previous electronic experience is necessary to complete this lab, a basic knowledge of electronics and circuit assembly is strongly recommended (such as acquired after the completion of the Chaney "33 in 1 Deluxe Electronic Exploration Kit").

Completion Of This Lab:

We strongly recommend the student follow the order of the activities (parts inventory, pre-activity, lessons, and experiments) as they appear in this manual. In the parts inventory the student will become acquainted with the electronic components used in this lab. In the pre-activity the student will solder pins to some components and assemble the tuner board. The pre-activity will need to be done only once in the life of the lab. It will be helpful to have somebody with previous experience in electronic soldering completing this assembly. No soldering is necessary to complete any of the experiments, as the students will use and reuse the tuner board and components prepared in the pre-activity.

The team of engineers, artists, editors, and employees at Chaney Electronics Inc. have put forth the maximum effort to make this lab a meaningful and exciting experience for the students. We hope we have accomplished our objective. We welcome your comments.

















Parts Inventory

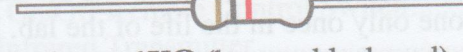

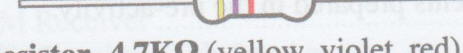
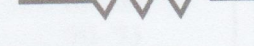
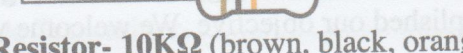

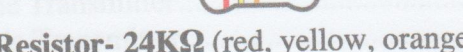

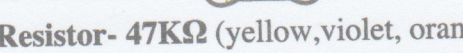
This activity will help you to get acquainted with the electronic components used in this lab and will verify that you have everything you need to complete the experiments.



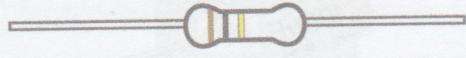





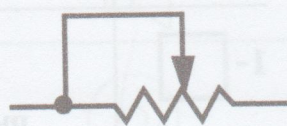
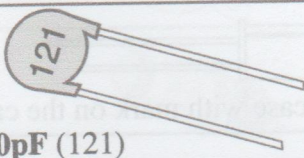
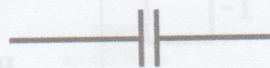
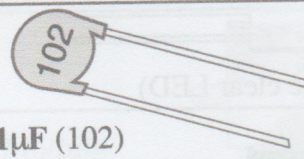
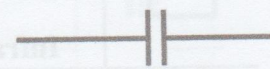
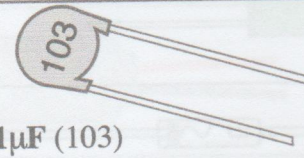
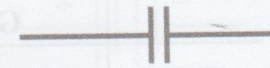
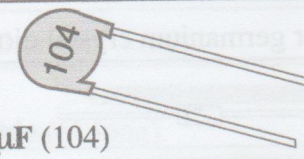
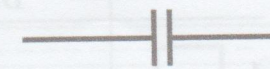
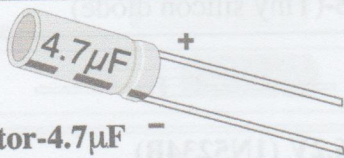
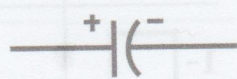
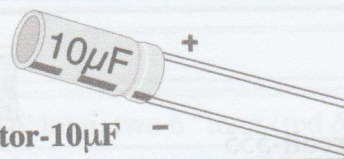
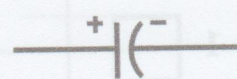
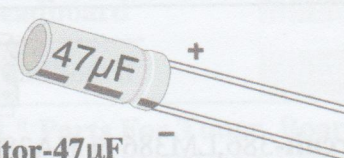
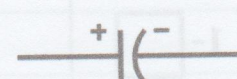

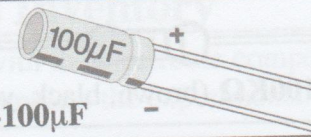
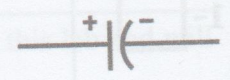
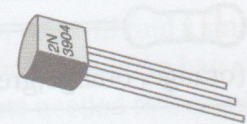
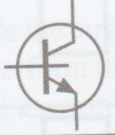
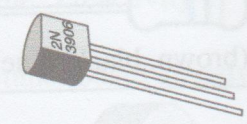

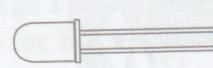
If you are the first person working on this lab, you will find a small plastic bag with parts inside the large plastic bag. Make an inventory of the large bag. The large bag contains the parts needed to perform the experiments. The small bag contains the parts needed to assemble the tuner board. You will assemble the tuner board after the parts inventory in the "Preactivity".

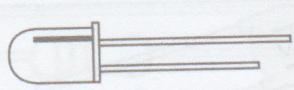
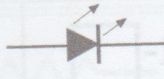
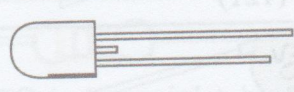
If you are reusing the lab, you will find the tuner board already assembled.

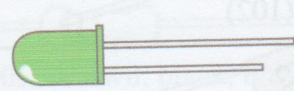
Large Plastic Bag (Parts for Experiments)

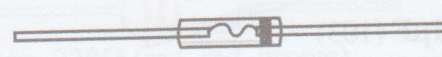
Qty.	Item	Schematic Symbol
1- <input type="checkbox"/>	 Resistor- 10Ω (brown, black, black)	
1- <input type="checkbox"/>	 Resistor- 47Ω (yellow, violet, black)	
2- <input type="checkbox"/>	 Resistor- 100Ω (brown, black, brown)	
1- <input type="checkbox"/>	 Resistor- 220Ω (red, red, brown)	
1- <input type="checkbox"/>	 Resistor- 1KΩ (brown, black, red)	
2- <input type="checkbox"/>	 Resistor- 4.7KΩ (yellow, violet, red)	
2- <input type="checkbox"/>	 Resistor- 10KΩ (brown, black, orange)	
2- <input type="checkbox"/>	 Resistor- 24KΩ (red, yellow, orange)	
1- <input type="checkbox"/>	 Resistor- 47KΩ (yellow, violet, orange)	

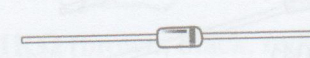
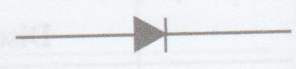
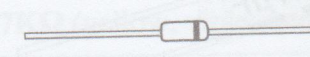
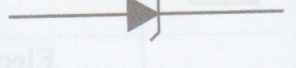
Qty.	Item	Schematic Symbol
1- <input type="checkbox"/>	 <p>Resistor- 100KΩ (brown, black, yellow)</p>	
1- <input type="checkbox"/>	 <p>Resistor- 3.3MΩ (orange, orange, green)</p>	
1- <input type="checkbox"/>	 <p>Resistor- 10MΩ (brown, black, blue)</p>	
1- <input type="checkbox"/>	 <p>Potentiometer- 50KΩ</p>	
1- <input type="checkbox"/>	 <p>Disc Capacitor-120pF (121)</p>	
1- <input type="checkbox"/>	 <p>Disc Capacitor-.001μF (102)</p>	
2- <input type="checkbox"/>	 <p>Disc Capacitor-.01μF (103)</p>	
2- <input type="checkbox"/>	 <p>Disc Capacitor-.1μF (104)</p>	
1- <input type="checkbox"/>	 <p>Electrolytic Capacitor-4.7μF</p>	
2- <input type="checkbox"/>	 <p>Electrolytic Capacitor-10μF</p>	
1- <input type="checkbox"/>	 <p>Electrolytic Capacitor-47μF</p>	

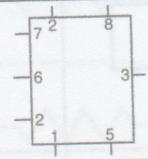
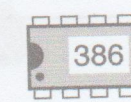
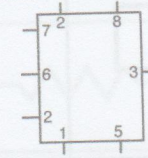
Qty.	Item	Schematic Symbol
1- <input type="checkbox"/>	 <p>Electrolytic Capacitor-100µF</p>	
2- <input type="checkbox"/>	 <p>Transistor-2N3904</p>	
1- <input type="checkbox"/>	 <p>Transistor-2N3906</p>	
1- <input type="checkbox"/>	 <p>Phototransistor-(small clear LED type)</p>	
1- <input type="checkbox"/>	 <p>RED LED-(clear case with mark on the case)</p>	
1- <input type="checkbox"/>	 <p>Infrared LED-(smoke clear LED)</p>	
1- <input type="checkbox"/>	 <p>Green LED</p>	
1- <input type="checkbox"/>	 <p>Diode 1N60-(larger germanium crystal diode)</p>	
1- <input type="checkbox"/>	 <p>Diode 1N4148-(Tiny silicon diode)</p>	
1- <input type="checkbox"/>	 <p>Zener Diode 6.2V (1N5234B)</p>	
1- <input type="checkbox"/>	 <p>Integrated Circuit-555</p>	
1- <input type="checkbox"/>	 <p>Integrated Circuit-386,LM386 or KA386</p>	

Pre-activity

Objective: In this preactivity you will assemble the tuner board that you will use in the radio communication experiments, and you will add solid terminals to some components of this lab. Once these tasks are completed, the lab will be ready for use and no more soldering will be required. If you lack experience soldering and assembling electronic kits, have somebody with experience do this job. It will take just a few minutes and we have provided complete step-by-step instructions.

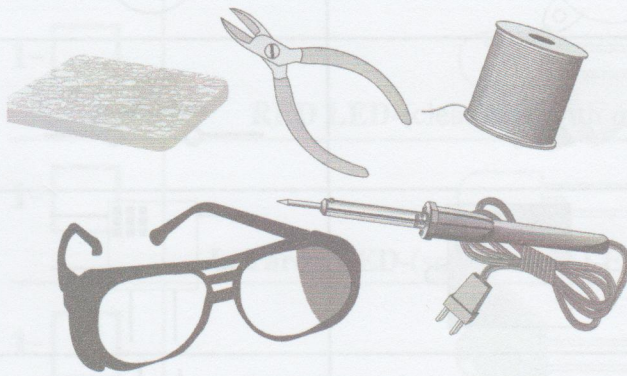

Figure 1 - Tools needed for assembling the tuner board

Tools Needed:

- Small Pencil type soldering iron (40 watts rating or less)
- Pair of wire cutters
- Pair of safety goggles or safety eyeglasses
- Fresh Rosin Core 63/37 Tin/Lead solder
(*Note: do not use acid core solder or acid flux as it will destroy the board and it will not be able to be repaired.*)
- Damp sponge.

Section 1: Assembling The Tuner Board

Open the plastic bag containing the parts to assemble the tuning board. Make an inventory according to the following parts list and parts layout (Figure 2).

R1	Resistor- 220 Ω (red, red, brown)
R2	Resistor- 4.7K Ω (yellow, violet, red)
R3	Resistor- 10K Ω (brown, black, orange)
C1	AM Tuning Capacitor
C2	Disc Capacitor- 5pF
C3	Disc Capacitor- .001uF (102)
C4	Electrolytic Capacitor- 10uF
C5	FM Tuning Capacitor
Q1	Transistor- 2N3904
L1-L2	Antenna Coil
L3-L4	FM Coils
Antenna	Piece of Wire 10" long
Misc.	Circuit Board, Solid Wire 4" long: 8 pieces, Tuning Capacitor, Plastic Knob, double sided tape, 2 screws.

Parts Layout, Parts List & Schematic

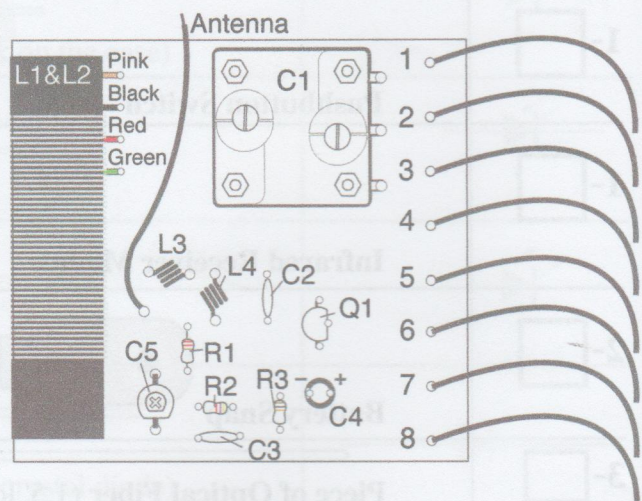

Figure 2 - Parts Layout

Assembly Instructions:

1. Assemble per parts layout (Figure 2), parts list and schematic (Figure 3) using 60/40 rosin core solder only. Acid core solder or acid fluxes will ruin the kit.
2. Install resistors R1, R2 and R3 per parts list and parts layout. Use the Parts inventory (pages 6-9) if you need help identifying components.
3. Install disc capacitors C2 and C3 as shown. No polarity needs to be observed.
4. Install electrolytic capacitor C4, with the correct polarity, as shown in the parts layout.

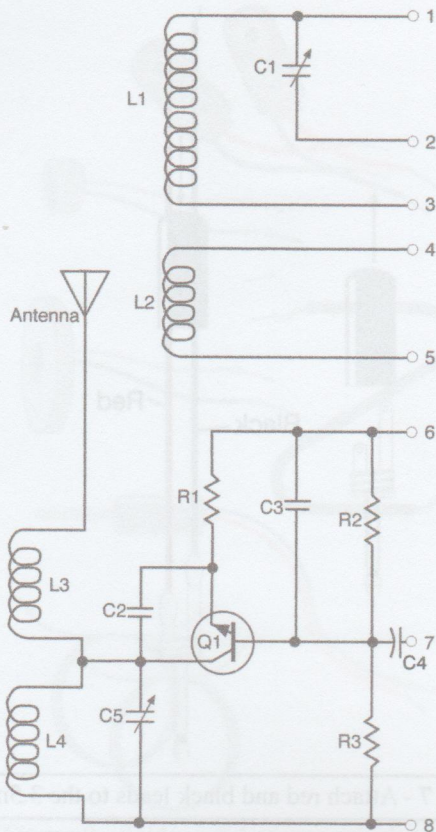

Figure 3 - Schematic Diagram

5. Install transistor Q1 with the flat side in the direction shown.
6. Install FM coils L3 and L4 as shown. Be sure the leads are properly soldered to the board.
7. Install FM Tuning Capacitor C5.
8. Install AM Tuning Capacitor C1. Secure it by using the two provided screws.
9. Solder eight solid wires to holes 1 to 8. The number of each hole is printed on the soldering side.
10. Install the Antenna wire (approx. 10" long).
11. Assemble antenna coil (L1&L2) by inserting the coil into ferrite core (you may need to partially flatten the coil to insert the bar). Cut the supplied piece of double sided tape in two. Attach the antenna coil to the board in the position shown in figure 2 using the two pieces of double sided tape. Solder the four colored wires to the board in the correct places, as shown in the parts layout.

12. Screw the knob and shaft into the threaded hole in capacitor C1 from the soldering side of the board, as shown in figure 4. Adjust the screws on the knob to ensure it is secured to the shaft. Be sure the knob can rotate freely without touching the solder on the board.

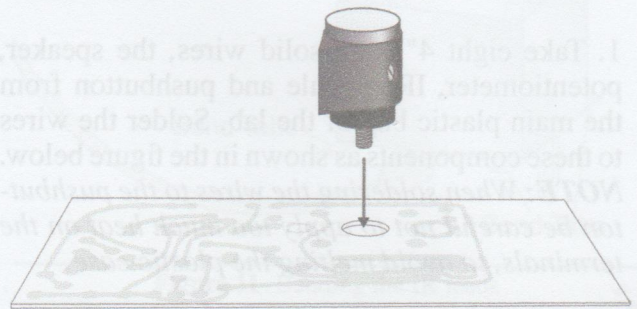

Figure 4 - Installing the tuning knob

13. Adjust the two trimmer capacitors in the back of C1 so that the two "D" shaped plates on each trimmer do not overlap each other, as shown in figure 5.

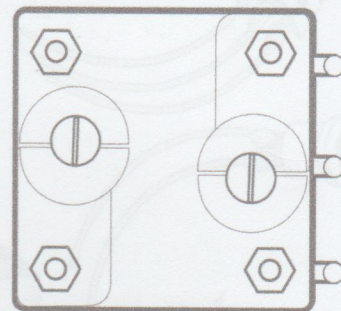

Figure 5 - Setting the "D" Plates

14. After assembly be sure that all the components were installed in the correct place and with the correct polarity. Carefully compare your assembled kit to the parts layout and parts list. You will not test the tuner board until you use it in the experiments. For this reason, you need to be sure that it was properly assembled per parts layout (Figure 2) and parts list. It is highly recommended to have somebody else inspect your board and soldering connections for proper assembly.

Section 2: Adding Solid Terminals To The Components

In this section of the preactivity you will add solid wires to some components and solid terminals to the leads of other components to make it possible to connect these components to the solderless breadboard.

1. Take eight 4" long solid wires, the speaker, potentiometer, IR module and pushbutton from the main plastic bag of the lab. Solder the wires to these components as shown in the figure below. **NOTE:** When soldering the wires to the pushbutton be careful not to apply too much heat on the terminals, to avoid melting the plastic case.

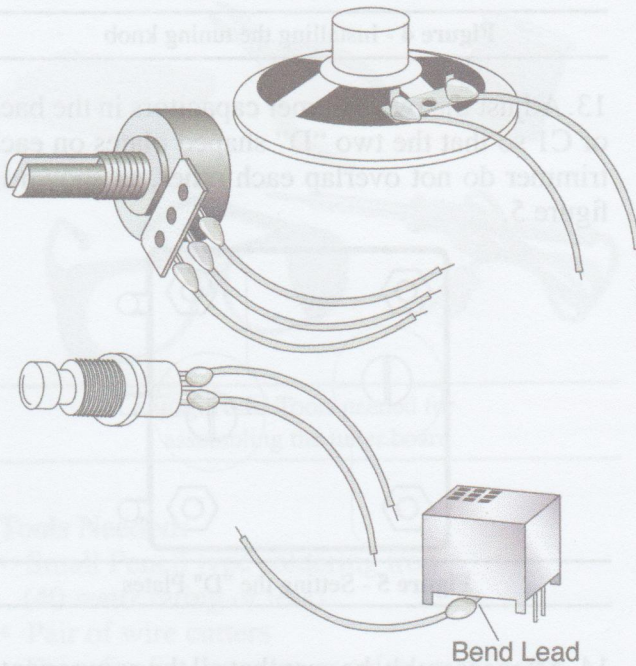

Figure 6 - Attach leads to the above components

2. Get the two pieces of stranded wire (red and black 5" long) and the 3.5 mm plug connector. Remove the cover from the connector and solder the red and black wire as shown. The red wire is connected to the center of the plug; the black wire is connected to ground of the plug. After soldering reinstall the plug cover by sliding it over the wires.

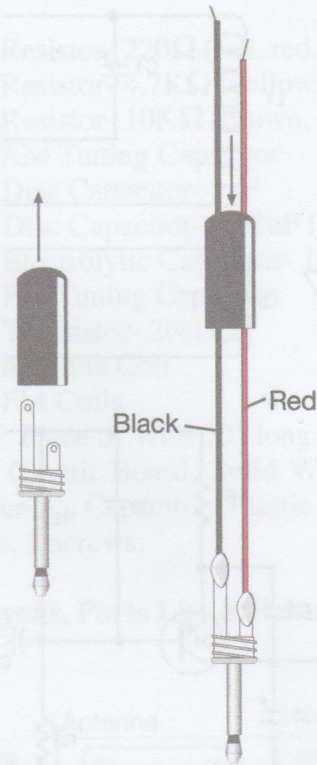

Figure 7 - Attach red and black leads to the 3.5mm plug

3. Take three 4" solid wires. Remove the plastic insulation off each of them to leave the naked wire. Cut 14 pieces of wire about 1/2" long. You will use these pieces to add to the terminals of some components.

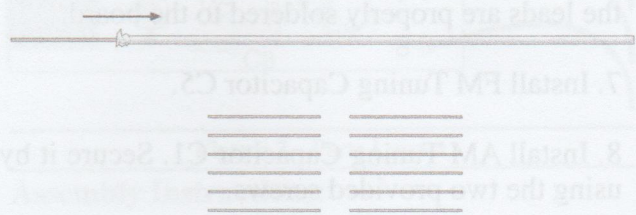

Figure 8 - Use solid wire to make 1/2" terminals

4. Solder the 1/2" long pieces of solid wire that you just cut to the wires of the electret microphone, piezo speaker, battery snaps, 3.5mm plug, both sides of the 5' wire and both sides of the coaxial cable, as shown in figure 9.

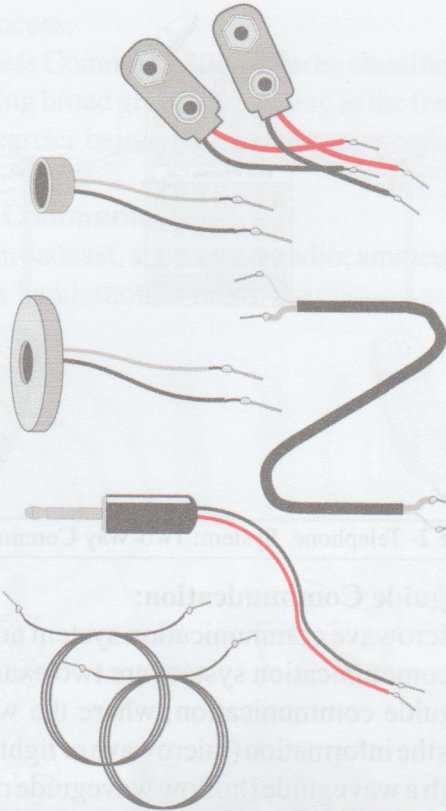

Figure 9 - Solder solid wire terminals to the above components

5. When working on the experiments of this lab it is useful to use a pair of long nose pliers to insert the leads of components into the breadboard, especially those components that have the solid wire terminals added to them, as shown below.

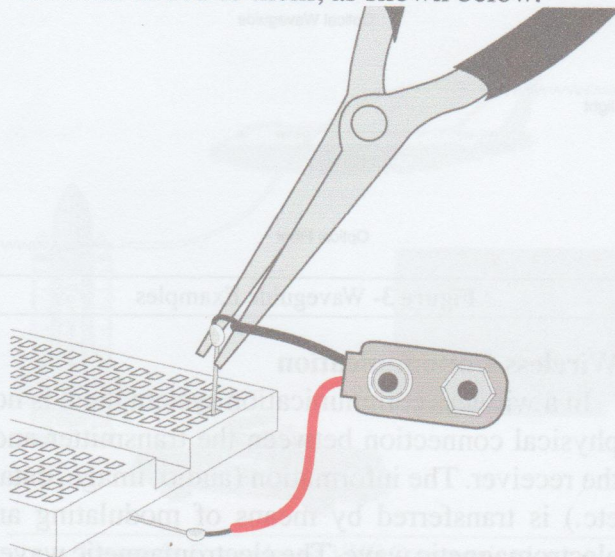

Figure 10 - Use long nosed pliers to insert the lead into the breadboard

6. Now trim the leads of the electrolytic capacitors so that they are the same length. This makes their installation onto the breadboard much easier.

7. Fold all the tabs of the IR module out as shown in Figure 11.

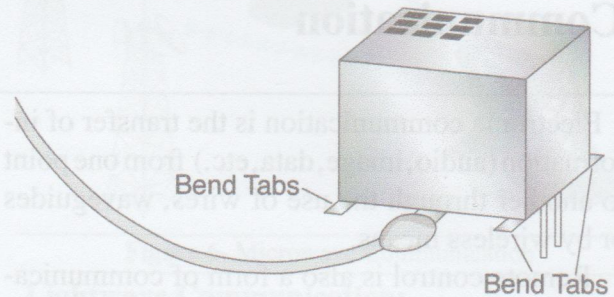

Figure 11- Bending the IR leads

Note About Breadboards: In this lab we supply two different sized breadboards. In the experiments the "Large Breadboard" is the one with **more rows**, and not necessarily the physically larger breadboard.

This concludes the preactivity. Now you can move on to Lesson 1.

Lesson 1-

Electronic Communication

Electronic communication is the transfer of information (audio, image, data, etc.) from one point to another through the use of wires, waveguides or by wireless means.

Remote control is also a form of communication in which a transmitter sends information to a receiver to control a remote device, such as the tuner of a TV or VCR, a garage door opener, a model car or plane, etc.

Wired Communication:

A public address system (PA system) made up of a microphone, amplifier and speakers is an example of a one-way wired communication system. In this system, the transfer of information flows through wires in one direction only, from the microphone to the speakers.

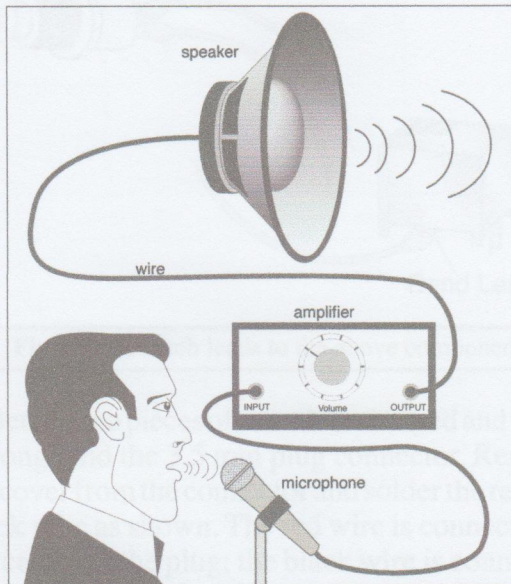

Figure 1- PA System; One-Way Communication

A telephone systems is an example of a two-way wired communication system, where the transfer of information can go through the wires in both directions.

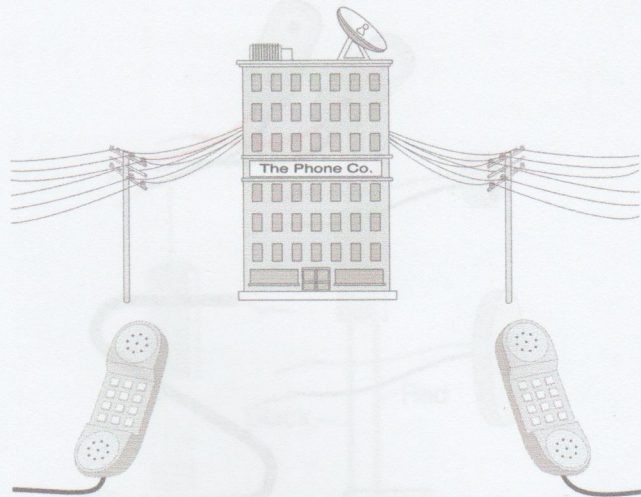

Figure 2- Telephone System; Two-Way Communication

Waveguide Communication:

A microwave communication system and a fiber optic communication system are two examples of waveguide communication, where the wave that carries the information (microwave or light), travels through a waveguide (hollow waveguide or optical fiber) from the transmitter to the receiver. Fiber optics communication is becoming very popular. Many wired telephone links are being replaced by fiber optic links, which offer noise-free, crystal clear sound.

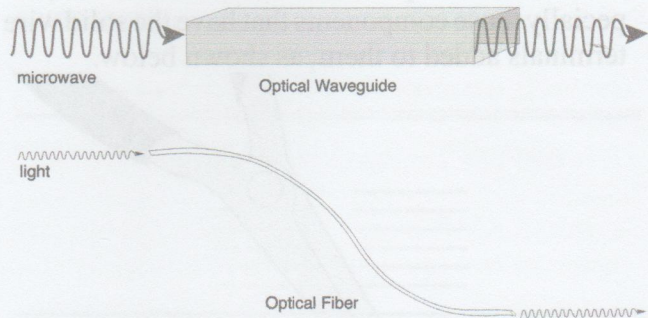

Figure 3- Waveguide Examples

Wireless Communication

In a wireless communication system there is no physical connection between the transmitter and the receiver. The information (audio, image, data, etc.) is transferred by means of modulating an electromagnetic wave. The electromagnetic wave, which has the ability to travel through space, acts as the "carrier" of the information. In Lessons 2, 3, and 4 you will learn more about electromagnetic waves, wireless communication and the modula-

tion process.
 Wireless Communications can be classified in the following broad groups according to the frequency of the carrier being use of electromagnetic wave:

Radio Communication:

AM broadcast, short-wave radio, amateur radio, citizens band, mobile radio, etc.

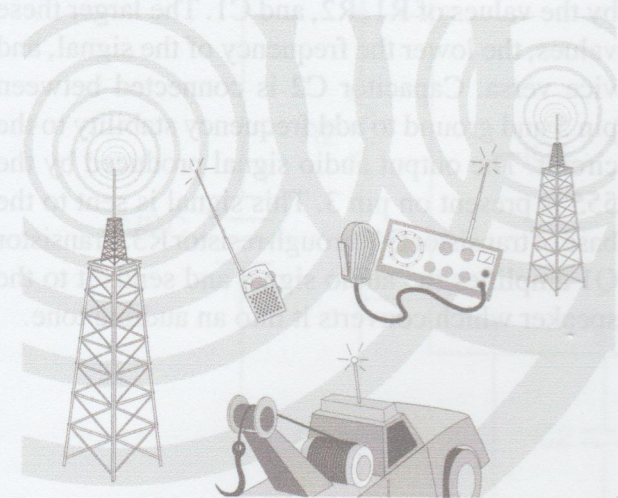

Figure 4- Common Uses of Radio Communication

VHF (Very High Frequencies) & UHF (Ultra High Frequencies):

FM radio, TV, amateur radio, aircraft, police, space (NASA), etc.

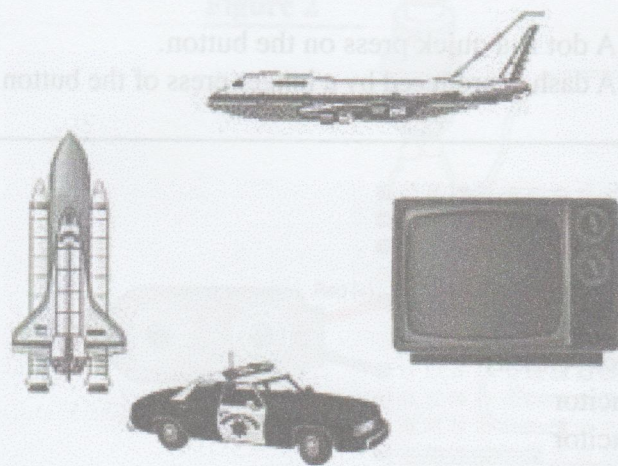

Figure 5- Examples of VHF Communication

Microwave Communication:

Long distance telephone, communication satellite, corporate communication systems, etc.

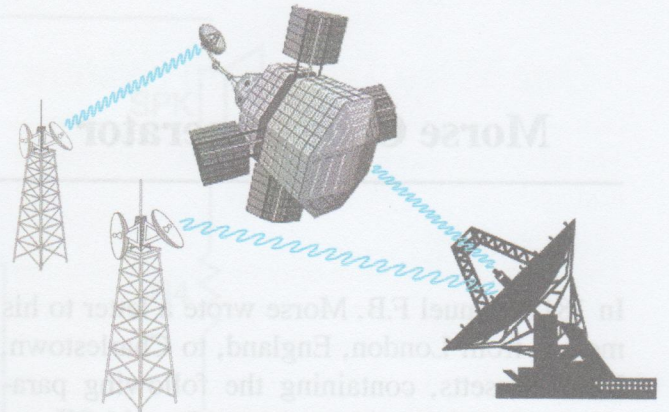

Figure 6- Microwave Communication

Lightwave Communication:

Laser communication systems, infrared (IR) remote control and data transmission, line-of-site light data links, etc.

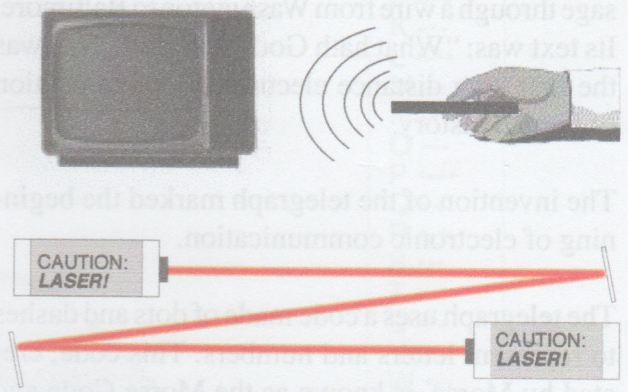

Figure 7- Lightwave Communication

In this Chaney Lab you will experiment with several types of the communication systems mentioned above. You will start building wired communication systems and then move on to wireless lightwave links, waveguide communication (fiber optics), IR remote control and proximity detection. Finally you will study wireless radio communication where you will build receivers and transmitters. We have left the radio communication experiments to the end as they are a little more complicated to build and make them work.

Experiment 1-

Morse Code Generator

In 1811 Samuel F.B. Morse wrote a letter to his mother from London, England, to Charlestown, Massachusetts, containing the following paragraph: "I wish that in one instant I could tell you of my safe arrival, but we are 3,000 miles apart and must wait four long weeks to hear from each other." After many years of study and hard work, the wish of this American artist and inventor became a reality, when in 1837 he applied for a patent for "The American Electromagnetic Telegraph." In May of 1844, Morse transmitted the first telegraphic message through a wire from Washington to Baltimore. Its text was: "What hath God wrought?" This was the first long distance electronic communication of human history.

The invention of the telegraph marked the beginning of electronic communication.

The telegraph uses a code made of dots and dashes to represent letters and numbers. This code, created by Morse, is known as the Morse Code and it is still in use today.

In this experiment, you will build a tone generator that can be used to generate the dots and dashes of the Morse Code. In Experiment 2 you will build a "One Wire Telegraph System".

The schematic diagram of this experiment is shown in Figure 1. In this circuit we use the 555 IC timer working as a clock to generate an audio signal. The frequency of this signal is controlled by the values of R1, R2, and C1. The larger these values, the lower the frequency of the signal, and vice versa. Capacitor C2 is connected between pin 5 and ground to add frequency stability to the circuit. The output audio signal produced by the 555 is present on pin 3. This signal is sent to the base of transistor Q1 through resistor R3. Transistor Q1 amplifies the audio signal and sends it to the speaker which converts it into an audible tone.

Procedure:

Assemble the circuit shown on figures 1 and 2 on the breadboard. Be sure to install the IC and the transistor in the correct direction. Connect a fresh 9 volt battery and press and release pushbutton S1 to produce the dashes and dots of the Morse Code.

A dot is a quick press on the button.

A dash is produced by a longer press of the button.

Parts List:

R1: 100K Ω Resistor (Brown, Black, Yellow)

R2: 47K Ω Resistor (Yellow, Violet, Orange)

R3: 4.7K Ω Resistor (Yellow, Violet, Red)

R4: 10 Ω Resistor (Brown, Black, Black)

C1: .01 μ F (103) Ceramic Capacitor

C2: .01 μ F (103) Ceramic Capacitor

IC1: 555 Integrated Circuit

Q1: 2N3904 NPN Transistor

S1: Pushbutton Switch

SPK: Speaker

Misc.: Battery snap, breadboard, and wires.

Figure 1

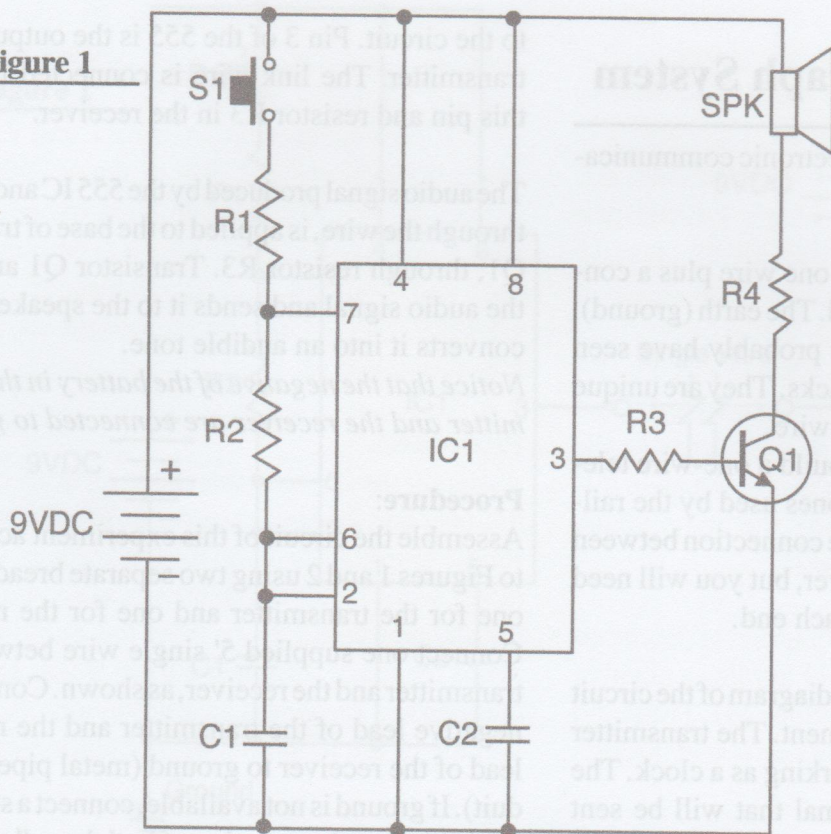

A	·-·-
B	····
C	···-
D	···-
E	·
F	···-
G	··-
H	····
I	··
J	··-·
K	··-·
L	···-
M	··-
N	··-
O	····
P	···-
Q	··-
R	···
S	···
T	-·
U	···
V	····
W	··-
Y	···-
Z	····
1	····
2	····
3	····
4	····
5	····
6	····
7	····
8	····
9	····
0	····

Figure 2

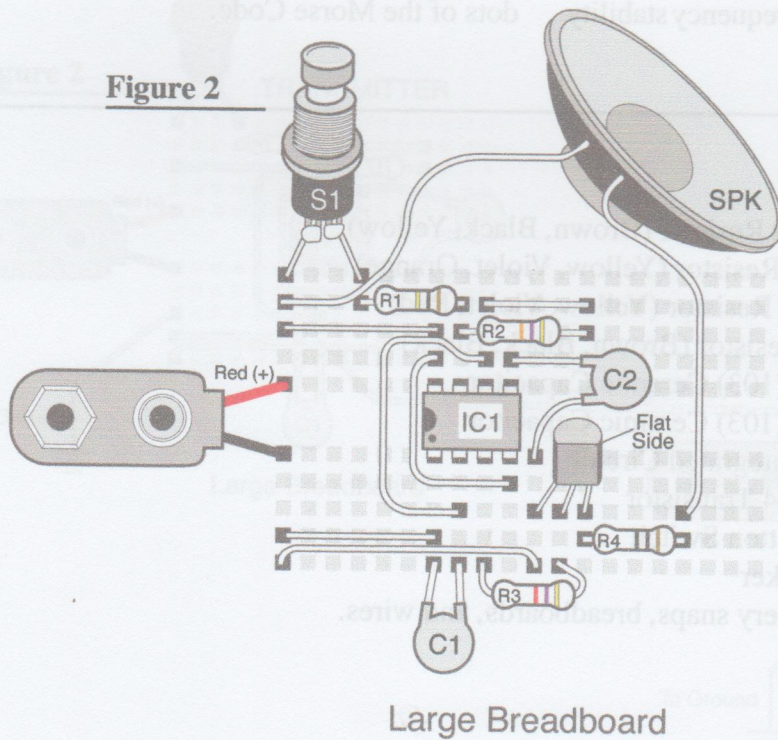

Experiment 2-

One Wire Telegraph System

The telegraph was the first electronic communication system.

The telegraph links use only one wire plus a connection to ground on each end. The earth (ground), acts as the second wire. You probably have seen telegraph poles by railroad tracks. They are unique because they carry only one wire.

In this experiment you will build a one-wire telegraph system similar to the ones used by the railroad. There is only a one-wire connection between the transmitter and the receiver, but you will need a connection to ground on each end.

Figure 1 shows the schematic diagram of the circuit you will build in this experiment. The transmitter is made up from a 555 IC working as a clock. The 555 generates the audio signal that will be sent through the wire to the receiver. The frequency of the audio signal is controlled by the values of R1, R2, and C1. The larger these values, the lower the frequency of the signal. Capacitor C2 is connected between pin 5 and ground to add frequency stability

to the circuit. Pin 3 of the 555 is the output of the transmitter. The link wire is connected between this pin and resistor R3 in the receiver.

The audio signal produced by the 555 IC and carried through the wire, is applied to the base of transistor Q1, through resistor R3. Transistor Q1 amplifies the audio signal and sends it to the speaker which converts it into an audible tone.

Notice that the negative of the battery in the transmitter and the receiver are connected to ground.

Procedure:

Assemble the circuit of this experiment according to Figures 1 and 2 using two separate breadboards, one for the transmitter and one for the receiver. Connect one supplied 5' single wire between the transmitter and the receiver, as shown. Connect the negative lead of the transmitter and the negative lead of the receiver to ground (metal pipe or conduit). If ground is not available, connect a second 5' wire between the negative of both breadboards, to simulate the connection through ground. Connect a fresh 9-volt battery to each breadboard and use pushbutton switch S1 to produce the dashes and dots of the Morse Code.

Parts List:

R1: 100K Ω Resistor (Brown, Black, Yellow)

R2: 47K Ω Resistor (Yellow, Violet, Orange)

R3: 4.7K Ω Resistor (Yellow, Violet, Red)

R4: 10 Ω Resistor (Brown, Black, Black)

C1: .01 μ F (103) Ceramic Capacitor

C2: .01 μ F (103) Ceramic Capacitor

IC1: 555 Integrated Circuit

Q1: 2N3904 Transistor

S1: Pushbutton Switch

SPK: Speaker

Misc.: Battery snaps, breadboards, and wires.

Figure 1

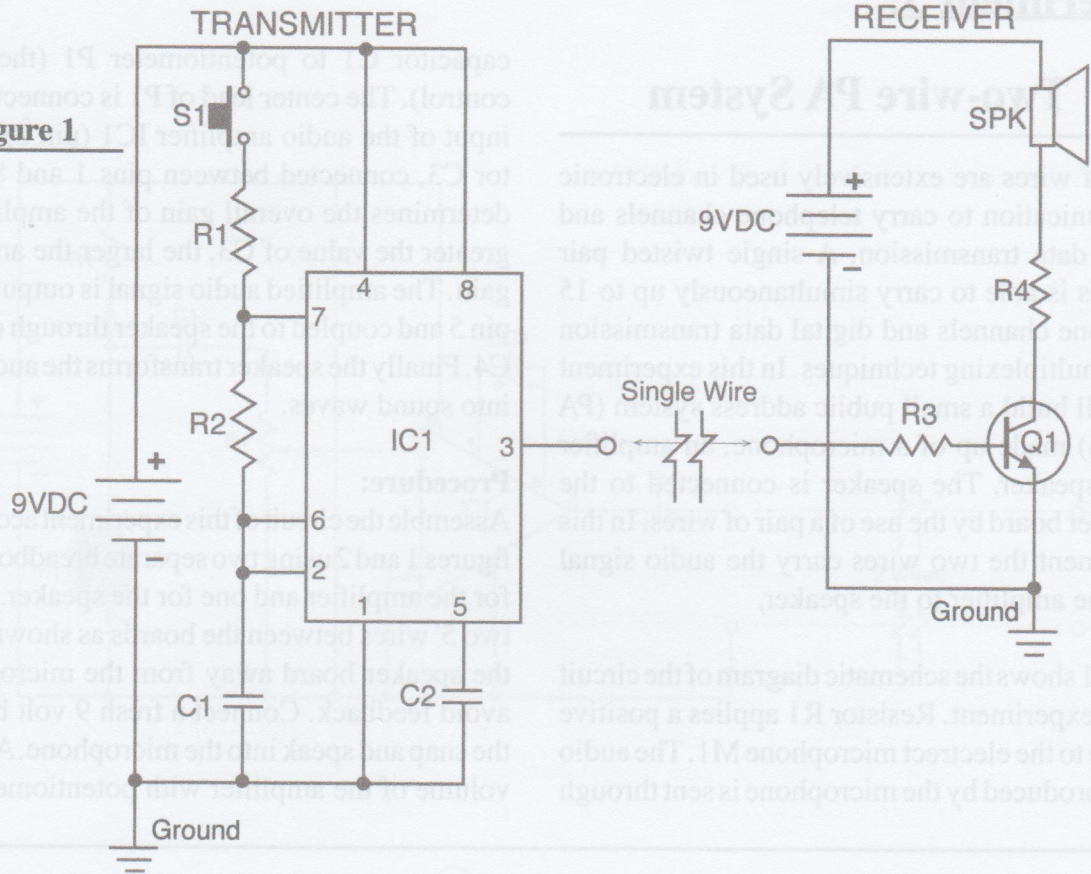
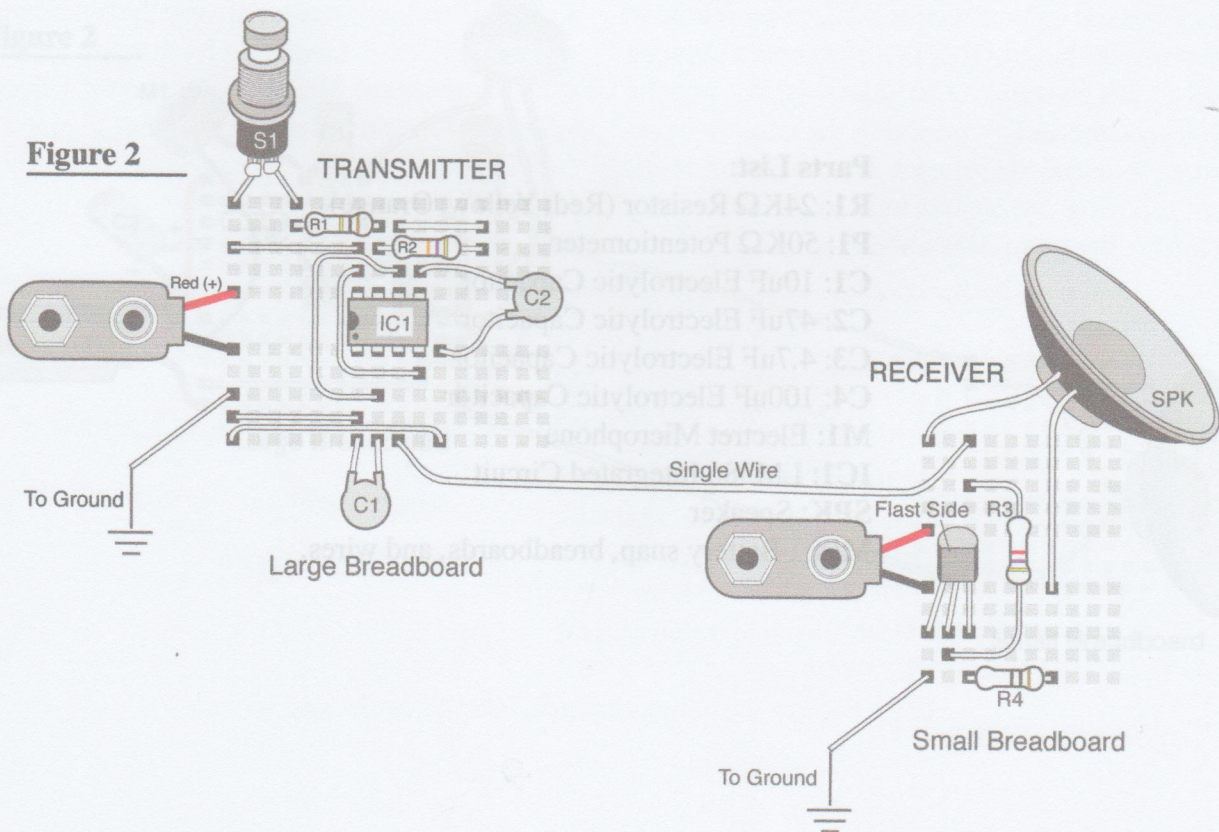

Figure 2



Experiment 3:

Two-wire PA System

Pairs of wires are extensively used in electronic communication to carry telephone channels and digital data transmission. A single twisted pair of wires is able to carry simultaneously up to 15 telephone channels and digital data transmission using multiplexing techniques. In this experiment you will build a small public address system (PA System) made up of a microphone, an amplifier and a speaker. The speaker is connected to the amplifier board by the use of a pair of wires. In this experiment the two wires carry the audio signal from the amplifier to the speaker.

Figure 1 shows the schematic diagram of the circuit of this experiment. Resistor R1 applies a positive voltage to the electret microphone M1. The audio signal produced by the microphone is sent through

capacitor C1 to potentiometer P1 (the volume control). The center lead of P1 is connected to the input of the audio amplifier IC1 (pin 3). Capacitor C3, connected between pins 1 and 8 of IC1, determines the overall gain of the amplifier. The greater the value of C3, the larger the amplifier's gain. The amplified audio signal is output through pin 5 and coupled to the speaker through capacitor C4. Finally the speaker transforms the audio signal into sound waves.

Procedure:

Assemble the circuit of this experiment according to figures 1 and 2 using two separate breadboards, one for the amplifier and one for the speaker. Connect two 5' wires between the boards as shown. Locate the speaker board away from the microphone to avoid feedback. Connect a fresh 9 volt battery to the snap and speak into the microphone. Adjust the volume of the amplifier with potentiometer P1.

Parts List:

R1: 24K Ω Resistor (Red, Yellow, Orange)

P1: 50K Ω Potentiometer

C1: 10uF Electrolytic Capacitor

C2: 47uF Electrolytic Capacitor

C3: 4.7uF Electrolytic Capacitor

C4: 100uF Electrolytic Capacitor

M1: Electret Microphone

IC1: LM386 Integrated Circuit

SPK: Speaker

Misc.: Battery snap, breadboards, and wires.

Figure 1

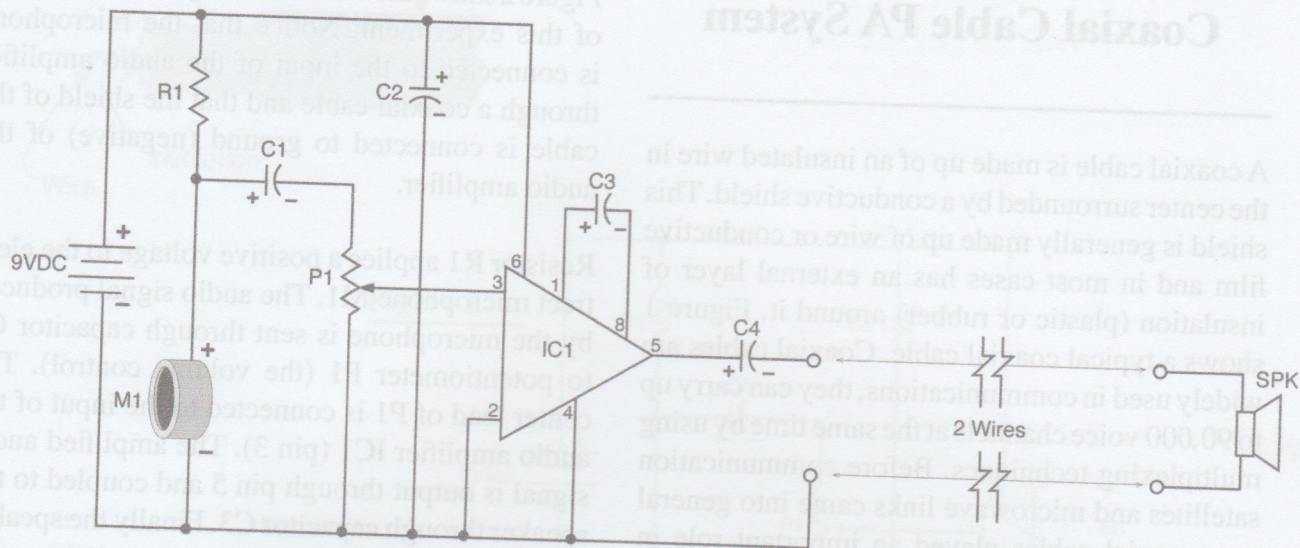
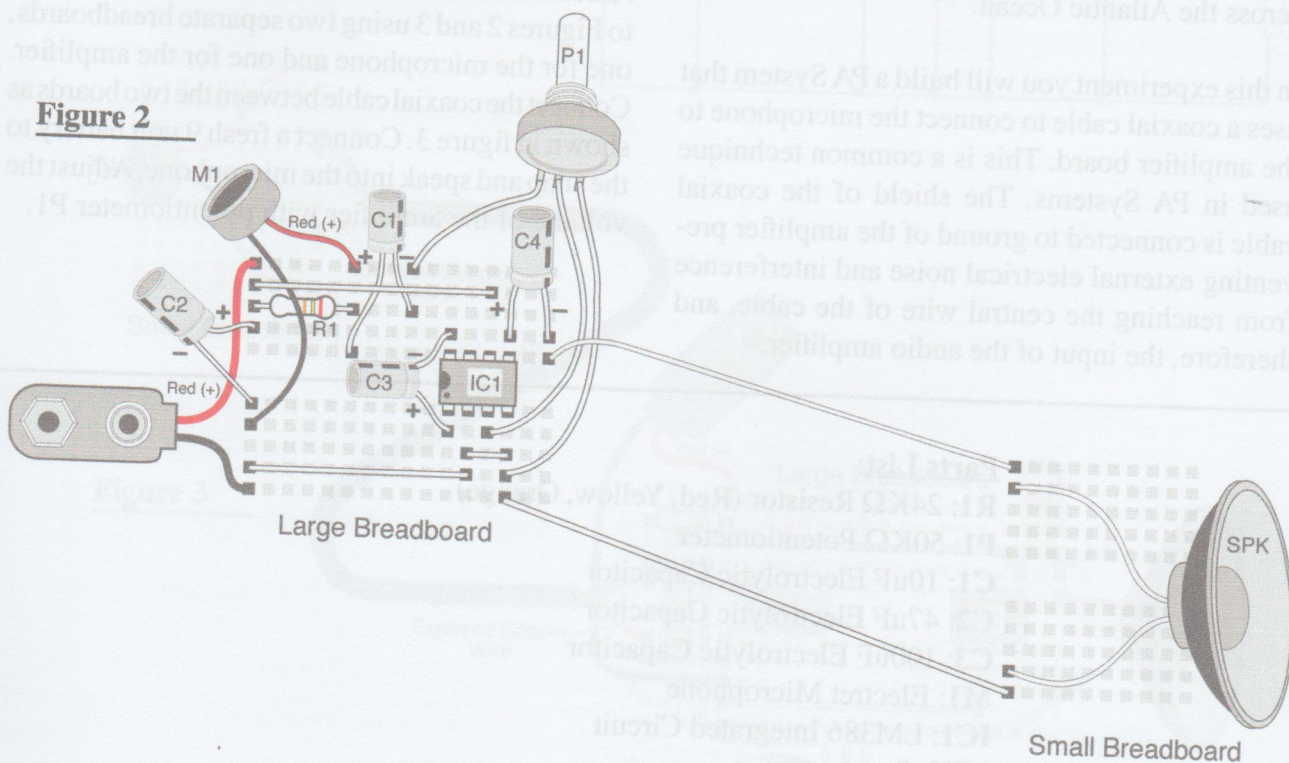

Figure 2



Experiment 4-

Two-wire PA System

Coaxial Cable PA System

A coaxial cable is made up of an insulated wire in the center surrounded by a conductive shield. This shield is generally made up of wire or conductive film and in most cases has an external layer of insulation (plastic or rubber) around it. Figure 1 shows a typical coaxial cable. Coaxial cables are widely used in communications, they can carry up to 90,000 voice channels at the same time by using multiplexing techniques. Before communication satellites and microwave links came into general use, coaxial cables played an important role in long distance communications. For example, the communication between America and Europe was totally done through coaxial cables laid down across the Atlantic Ocean.

In this experiment you will build a PA System that uses a coaxial cable to connect the microphone to the amplifier board. This is a common technique used in PA Systems. The shield of the coaxial cable is connected to ground of the amplifier preventing external electrical noise and interference from reaching the central wire of the cable, and therefore, the input of the audio amplifier.

Figure 2 shows the schematic diagram of the circuit of this experiment. Notice that the microphone is connected to the input of the audio amplifier through a coaxial cable and that the shield of the cable is connected to ground (negative) of the audio amplifier.

Resistor R1 applies a positive voltage to the electret microphone M1. The audio signal produced by the microphone is sent through capacitor C1 to potentiometer P1 (the volume control). The center lead of P1 is connected to the input of the audio amplifier IC1 (pin 3). The amplified audio signal is output through pin 5 and coupled to the speaker through capacitor C3. Finally the speaker transforms the audio signal into sound waves.

Procedure:

Assemble the circuit of this experiment according to Figures 2 and 3 using two separate breadboards, one for the microphone and one for the amplifier. Connect the coaxial cable between the two boards as shown in figure 3. Connect a fresh 9 volt battery to the snap and speak into the microphone. Adjust the volume of the amplifier with potentiometer P1.

Parts List:

R1: 24K Ω Resistor (Red, Yellow, Orange)

P1: 50K Ω Potentiometer

C1: 10 μ F Electrolytic Capacitor

C2: 47 μ F Electrolytic Capacitor

C3: 100 μ F Electrolytic Capacitor

M1: Electret Microphone

IC1: LM386 Integrated Circuit

SPK: Speaker

Misc.: Battery snap, breadboards, coaxial cable, and wires.

Figure 1

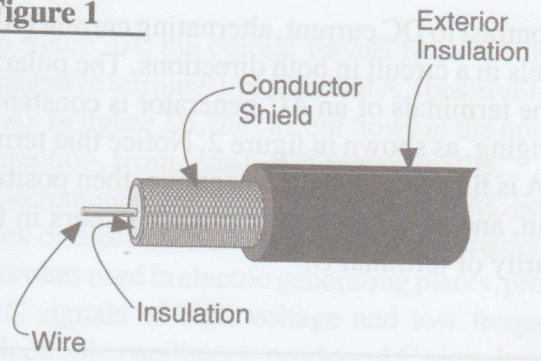

Figure 2

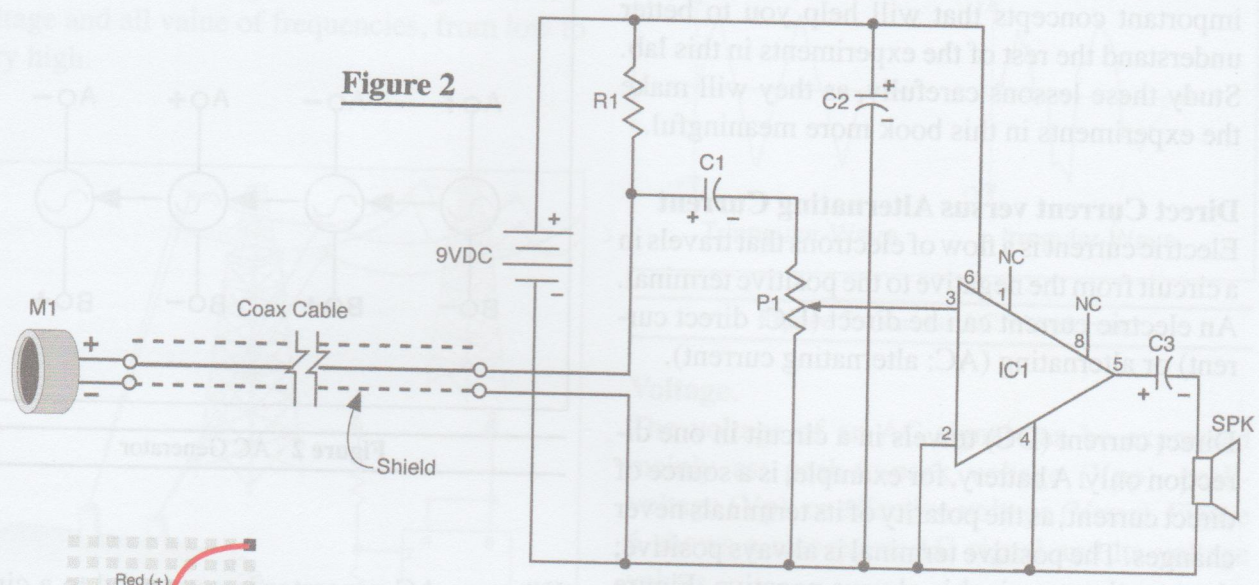
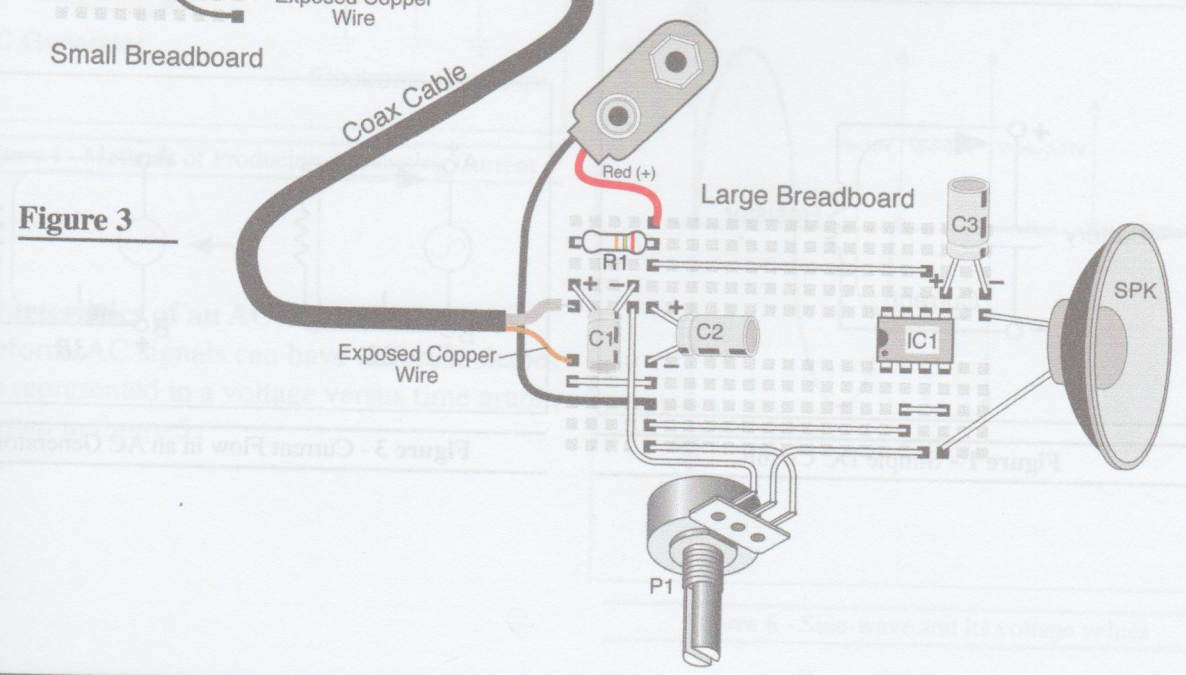

Figure 3



Lesson 2-

Alternating Current (AC) Characteristics

Note: In the next three lessons, we will introduce important concepts that will help you to better understand the rest of the experiments in this lab. Study these lessons carefully, as they will make the experiments in this book more meaningful.

Direct Current versus Alternating Current

Electric current is a flow of electrons that travels in a circuit from the negative to the positive terminal. An electric current can be direct (DC: direct current) or alternating (AC: alternating current).

Direct current (DC) travels in a circuit in one direction only. A battery, for example, is a source of direct current, as the polarity of its terminals never changes. The positive terminal is always positive; the negative terminal is always negative. Figure 1 shows a DC circuit made up of a battery and a resistor. In this circuit, the current always travels in the direction shown in the figure.

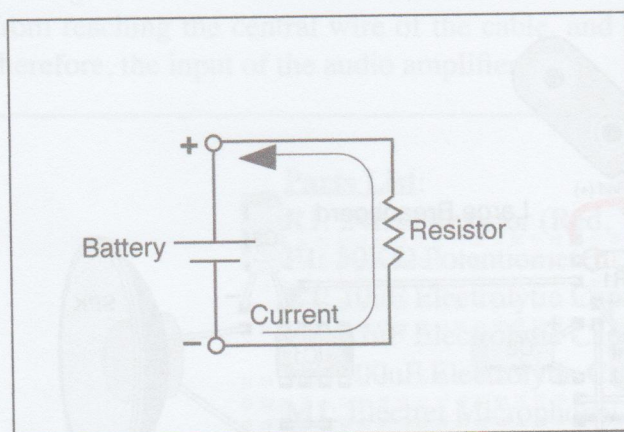

Figure 1 - Simple DC Circuit

In contrast to DC current, alternating current (AC) travels in a circuit in both directions. The polarity of the terminals of an AC generator is constantly changing, as shown in figure 2. Notice that terminal A is first positive, then negative, then positive again, and so on: A similar change occurs in the polarity of terminal B.

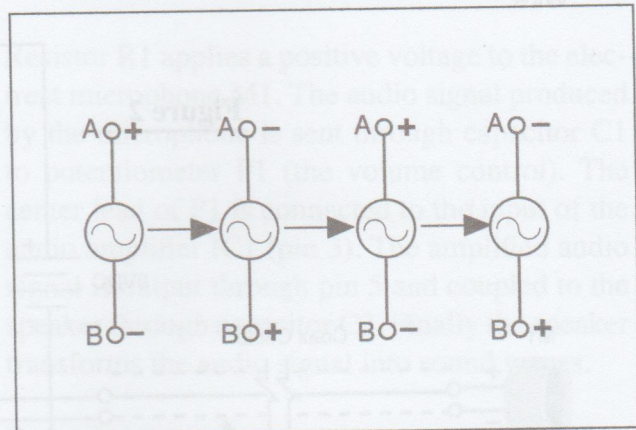

Figure 2 - AC Generator

When an AC generator is connected to a circuit, the current in the circuit is constantly changing directions, following the changes in the polarity of the generator, as shown in figures 3A and 3B.

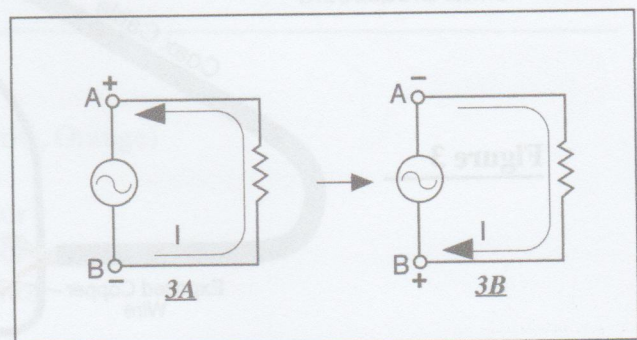

Figure 3 - Current Flow in an AC Generator

In figure 3A, the current travels from terminal B (negative terminal), to terminal A, (positive terminal). In figure 3B, the current flows in the opposite direction, from terminal A to terminal B.

Alternating current can be produced by AC generators or electronic oscillators. AC generators, like the ones used in electric generating plants, produce AC signals of high voltage and low frequency. Electronic oscillators, produce AC signals of low voltage and all value of frequencies, from low to very high.

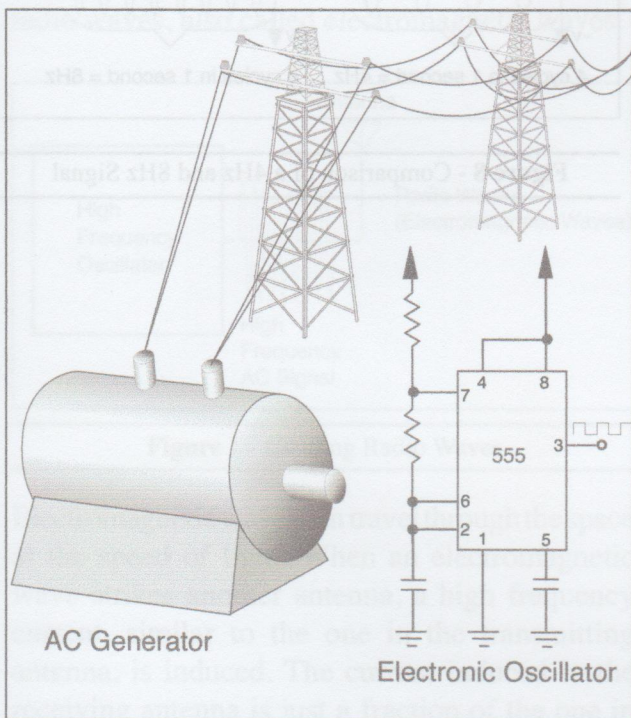

Figure 4 - Methods of Producing Alternating Current

Characteristics of an AC Signal

Waveform. AC signals can have different shapes when represented in a voltage versus time graph, as shown in figure 5.

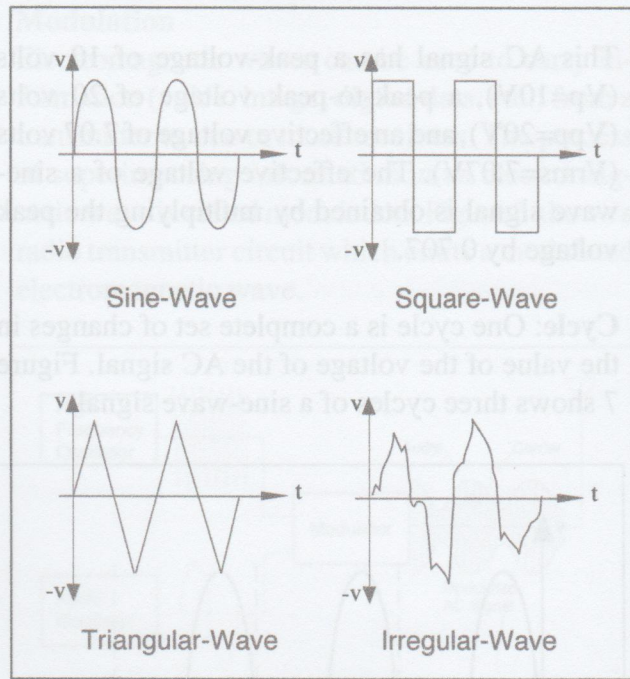

Figure 5 - Various AC Waveforms

Voltage.

The voltage of an AC signal can be expressed mainly as: peak-to-peak voltage (V_{pp}), peak-voltage (V_p), or effective voltage (V_{rms}). Figure 6 shows a sine-wave AC signal and its voltage values.

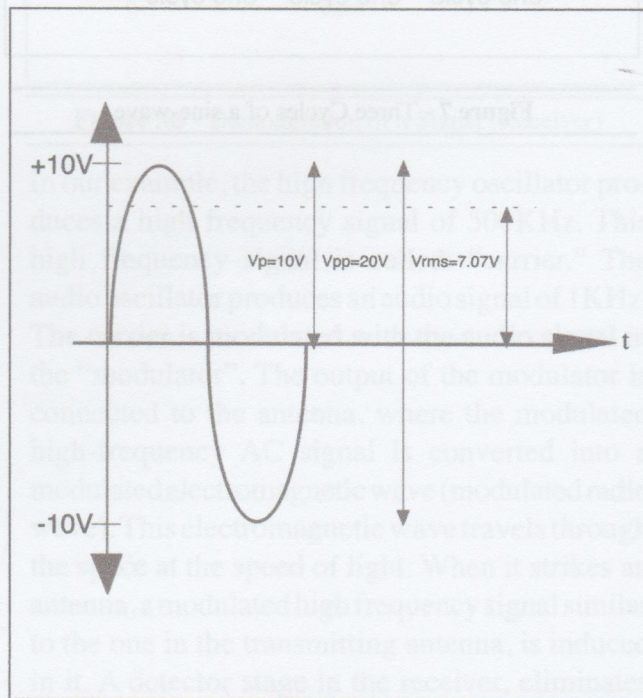

Figure 6 - Sine-wave and its voltage values

This AC signal has a peak-voltage of 10 volts ($V_p=10V$), a peak-to-peak voltage of 20 volts ($V_{pp}=20V$), and an effective voltage of 7.07 volts ($V_{rms}=7.07V$). The effective voltage of a sine-wave signal is obtained by multiplying the peak voltage by 0.707.

Cycle: One cycle is a complete set of changes in the value of the voltage of the AC signal. Figure 7 shows three cycles of a sine-wave signal.

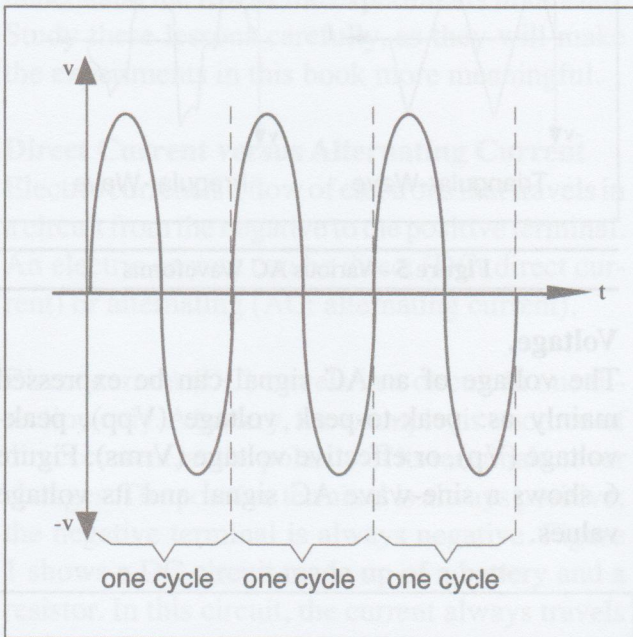

Figure 7 - Three Cycles of a sine-wave

Frequency:

The frequency of an AC signal indicates how many cycles occur in a second. Frequency is measured in Hertz. One Hertz represents one cycle per second. Figure 8 shows two AC signals, one of 4Hz and another of 8Hz. Radio communication signals have frequencies of millions of Hertz.

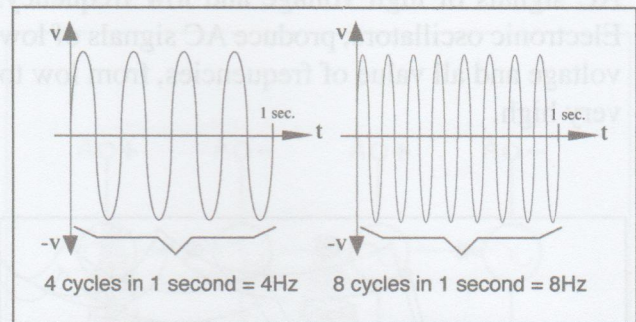

Figure 8 - Comparison of a 4Hz and 8Hz Signal

Lesson 3-

Radio Communication & Electromagnetic Waves

Radio Waves

AC signals of high frequency can be used to produce radio waves. By connecting the output of a high frequency oscillator (100KHz or more) to an antenna, radio waves can be emitted. The antenna converts high frequency alternating current into radio waves, also called electromagnetic waves.

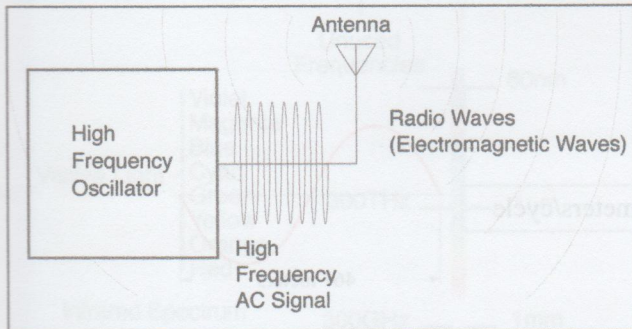

Figure 1 - Creating Radio Waves

Electromagnetic waves can travel through the space at the speed of light. When an electromagnetic wave strikes another antenna, a high frequency current, similar to the one in the transmitting antenna, is induced. The current induced in the receiving antenna is just a fraction of the one in the transmitting antenna; but it has all the same characteristic of the original signal: waveform, frequency, etc.

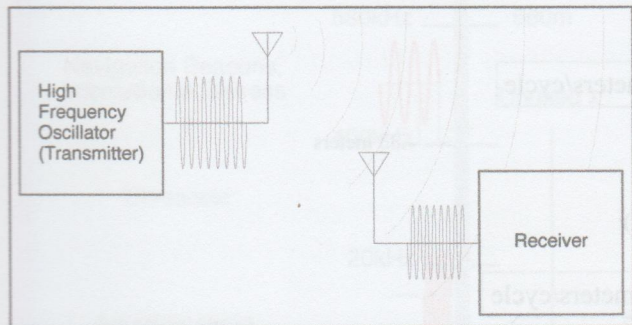

Figure 2 - Transmission of Radio Waves

Modulation

Electromagnetic waves can be used to carry information (voice, image, digital data, etc.) from a transmitter to one or more receivers. The process of superimposing information in an electromagnetic wave is called modulation. Figure 3 shows a radio transmitter circuit which emits a modulated electromagnetic wave.

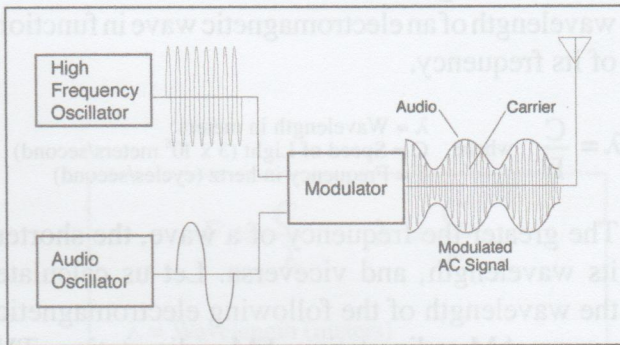

Figure 3A - Modulation of a Signal (Transmitter)

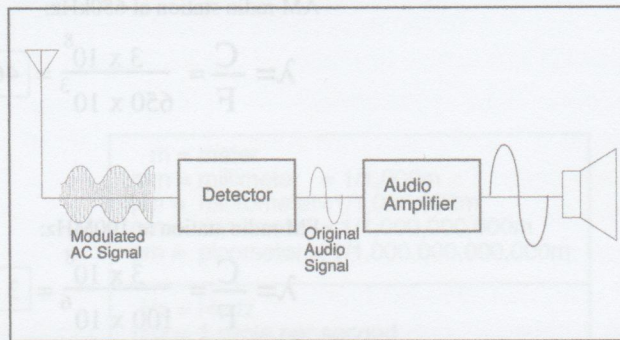

Figure 3B - Demodulation of a Signal (Receiver)

In our example, the high frequency oscillator produces a high frequency signal of 500KHz. This high frequency signal is called: "carrier." The audio oscillator produces an audio signal of 1KHz. The carrier is modulated with the audio signal in the "modulator". The output of the modulator is connected to the antenna, where the modulated high-frequency AC signal is converted into a modulated electromagnetic wave (modulated radio wave). This electromagnetic wave travels through the space at the speed of light. When it strikes an antenna, a modulated high frequency signal similar to the one in the transmitting antenna, is induced in it. A detector stage in the receiver, eliminates the carrier as it is not needed anymore, leaving only the audio signal. An audio amplifier in the

receiver, amplifies the audio signal and sends it to the speaker which converts the audio signal into sound waves.

Wavelength of an Electromagnetic Wave

Electromagnetic waves have a certain length that is measured in meters or its fractions. The Greek letter "lambda" (λ) is used to represent wavelength. The following formula can be used to calculate the wavelength of an electromagnetic wave in function of its frequency.

$$\lambda = \frac{C}{F} \quad \text{where} \quad \begin{array}{l} \lambda = \text{Wavelength in meters} \\ C = \text{Speed of Light } (3 \times 10^8 \text{ meters/second}) \\ F = \text{Frequency in hertz (cycles/second)} \end{array}$$

The greater the frequency of a wave, the shorter its wavelength, and viceversa. Let us calculate the wavelength of the following electromagnetic waves: AM radio station, FM radio station, TV station channel 13, TV station channel 83, and a microwave.

- AM radio station at 650kHz:

$$\lambda = \frac{C}{F} = \frac{3 \times 10^8}{650 \times 10^3} = 461 \text{ meters/cycle}$$

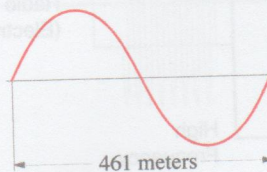

- FM radio station at 100MHz:

$$\lambda = \frac{C}{F} = \frac{3 \times 10^8}{100 \times 10^6} = 3 \text{ meters/cycle}$$

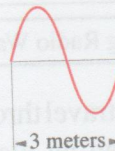

- TV station channel 13 at 216MHz:

$$\lambda = \frac{C}{F} = \frac{3 \times 10^8}{216 \times 10^6} = 1.3 \text{ meters/cycle}$$

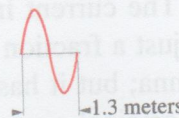

- TV station channel 83 at 890MHz:

$$\lambda = \frac{C}{F} = \frac{3 \times 10^8}{890 \times 10^6} = .33 \text{ meters/cycle}$$

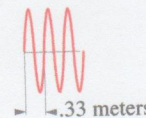

- Microwave at 300GHz (300,000MHz):

$$\lambda = \frac{C}{F} = \frac{3 \times 10^8}{300 \times 10^9} = .001 \text{ meters/cycle}$$

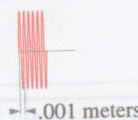

Light: a High Frequency Electromagnetic Wave

Light is nothing more than electromagnetic waves of very high frequency. The frequency of light waves is so high that it is not practical to talk in terms of frequency (Hertz) but rather in terms of wave length. The wave length of the visible spectrum (red to violet) ranges from 0.7 to 0.4 microns. One micron is one millionth of a meter.

Lesson 4-

The frequency spectrum shows in a vertical line, the different types of acoustical and electromagnetic waves, organized by frequency and wavelength. Take time to analyze and understand it, as it relates to the experiments of this lab.

Frequency Spectrum

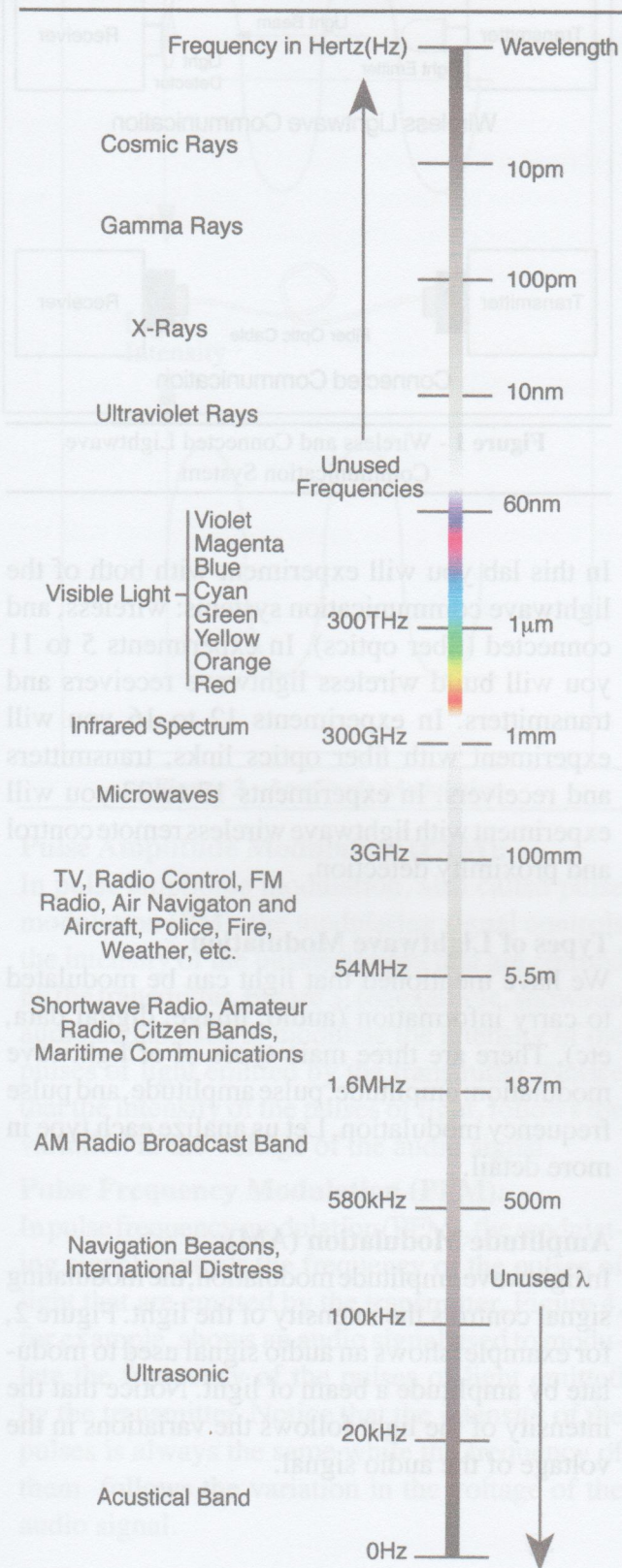

$$F = \frac{C}{\lambda} \quad \lambda = \frac{C}{F}$$

λ = Wavelength (meters)
 C = Speed of light (3×10^8 meters/second)
 F = Frequency (Hertz)

m = meter
 mm = millimeter = $1/1,000m$
 μm = micrometer = $1/1,000,000m$
 nm = nanometer = $1/1,000,000,000m$
 pm = picometer = $1/1,000,000,000,000m$

Hz = Hertz
 $1Hz$ = 1 cycle per second
 kHz = kilohertz = $1,000 Hz$
 MHz = Megahertz = $1,000,000Hz$
 GHz = Gigahertz = $1,000,000,000Hz$
 THz = Terahertz = $1,000,000,000,000Hz$

Lesson 5-

Wireless Lightwave Communication

Introduction.

In Lessons 3 and 4 you learned that light is an electromagnetic radiation of very high frequency. The only difference between light waves and radio communication waves is in the frequency. Electromagnetic waves used in radio communication, have frequencies ranging between 100KHz and 300GHz. Visible light waves have frequencies ranging between 400THz and 750THz. (1GHz =1,000 MHz and 1THz=1,000,000MHz). Because of the high frequency of the light waves, they are no longer referred to in terms of frequencies (Hz: Hertz) but rather in terms of wave lengths. The visible light spectrum has wave lengths ranging from 0.7 to 0.4 microns (one micron equals to a millionth of a meter).

You have learned that radio waves can be modulated to carry information: audio, image, digital data, etc. Light, can also be modulated with information. A lightwave communication link will include a transmitter and a receiver. The transmitter emits a modulated light beam; the receiver detects the light beam then extracts and processes the information modulated in the light. Lightwave communication links can be wireless or connected. In a wireless system, there is no physical link or connection between the transmitter and the receiver. The transmitter emits a modulated light beam that travels through the space and reaches the receiver. Connected lightwave communication systems, have a fiber optic cable connecting the transmitter to the receiver. This fiber optic cable acts as a waveguide for the light. The modulated light beam is emitted by the transmitter, travels through the optical fiber and reaches the receiver where it is detected and processed. Figure 1 shows the block diagram of a wireless and a connected lightwave communication system.

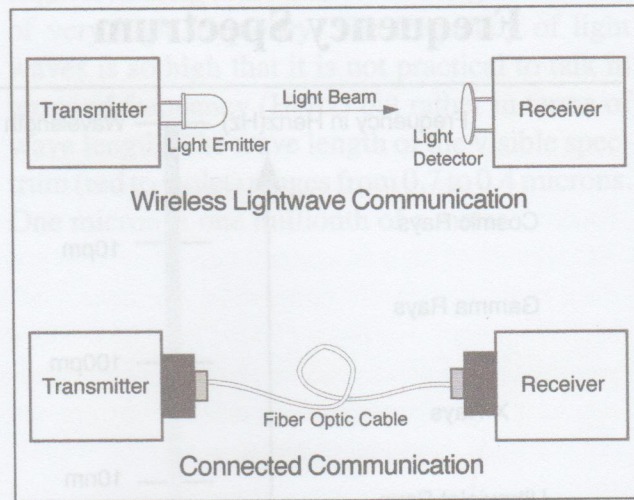

Figure 1 - Wireless and Connected Lightwave Communication System

In this lab you will experiment with both of the lightwave communication systems: wireless, and connected (fiber optics). In experiments 5 to 11 you will build wireless lightwave receivers and transmitters. In experiments 12 to 16 you will experiment with fiber optics links, transmitters and receivers. In experiments 17 to 23 you will experiment with lightwave wireless remote control and proximity detection.

Types of Lightwave Modulation

We have mentioned that light can be modulated to carry information (audio, image, digital data, etc). There are three main types of lightwave modulation: amplitude, pulse amplitude, and pulse frequency modulation. Let us analyze each type in more detail.

Amplitude Modulation (AM):

In lightwave amplitude modulation, the modulating signal controls the intensity of the light. Figure 2, for example, shows an audio signal used to modulate by amplitude a beam of light. Notice that the intensity of the light follows the variations in the voltage of the audio signal.

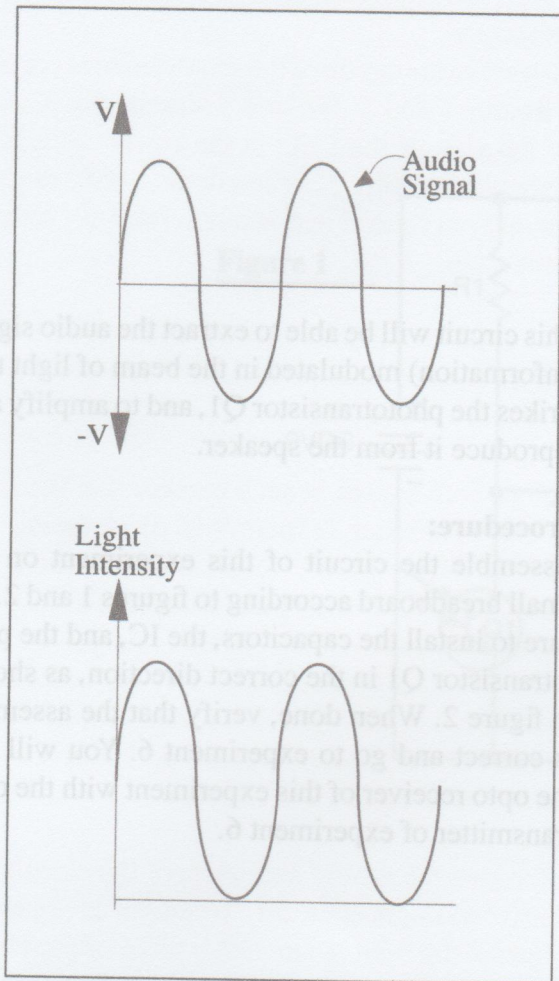

Figure 2 - Amplitude Modulation

Pulse Amplitude Modulation (PAM):

In pulse amplitude modulation, also called pulse modulation (PM), the modulating signal controls the intensity of the pulses of light that are emitted by the transmitter. Figure 3, for example, shows an audio signal used to modulate the intensity of the pulses of light emitted by the transmitter. Notice that the intensity of the pulses of light, follows the variation in the voltage of the audio signal.

Pulse Frequency Modulation (PFM):

In pulse frequency modulation (PFM), the modulating signal controls the frequency of the pulses of light that are emitted by the transmitter. Figure 4, for example, shows an audio signal used to modulate the frequency of the pulses of light emitted by the transmitter. Notice that the intensity of the pulses is always the same while the frequency of them follows the variation in the voltage of the audio signal.

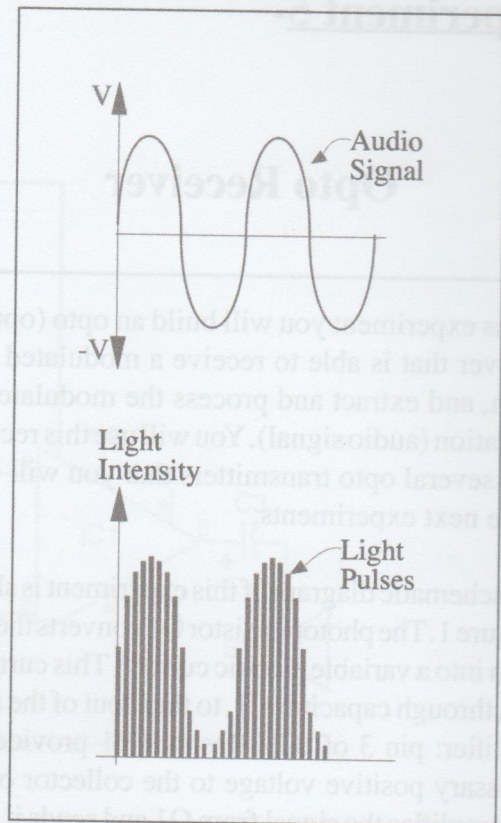

Figure 3 - Pulse Amplitude Modulation

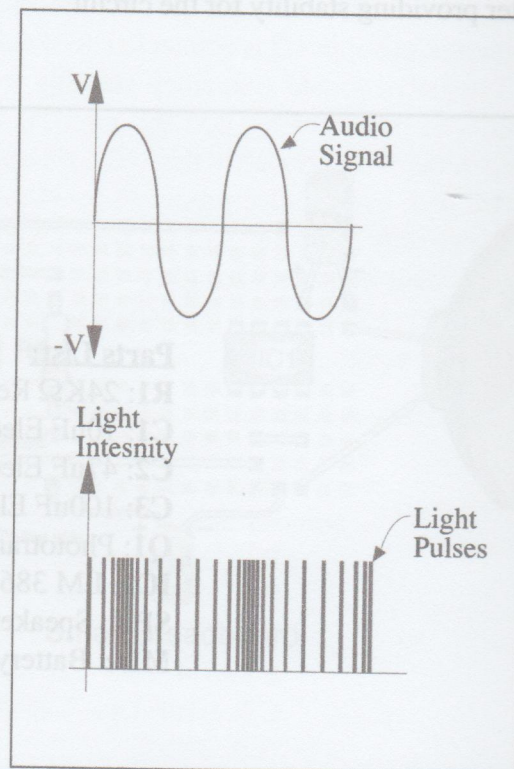

Figure 4 - Pulse Frequency Modulation

In this lab you will experiment modulating light by amplitude and pulse amplitude.

Experiment 5-

Opto Receiver

In this experiment you will build an opto (optical) receiver that is able to receive a modulated light beam, and extract and process the modulated information (audio signal). You will use this receiver with several opto transmitters that you will build in the next experiments.

The schematic diagram of this experiment is shown in figure 1. The phototransistor Q1 converts the light beam into a variable electric current. This current is sent, through capacitor C1, to the input of the audio amplifier: pin 3 of IC1. Resistor R1 provides the necessary positive voltage to the collector of Q1. IC1 amplifies the signal from Q1 and sends it to the speaker through capacitor C3. Capacitor C2 acts as a filter providing stability for the circuit.

This circuit will be able to extract the audio signal (information) modulated in the beam of light that strikes the phototransistor Q1, and to amplify and reproduce it from the speaker.

Procedure:

Assemble the circuit of this experiment on the small breadboard according to figures 1 and 2. Be sure to install the capacitors, the IC, and the phototransistor Q1 in the correct direction, as shown in figure 2. When done, verify that the assembly is correct and go to experiment 6. You will test the opto receiver of this experiment with the opto transmitter of experiment 6.

Parts List:

R1: 24K Ω Resistor (Red, Yellow, Orange)

C1: 10uF Electrolytic Capacitor

C2: 47uF Electrolytic Capacitor

C3: 100uF Electrolytic Capacitor

Q1: Phototransistor (small, clear LED type)

IC1: LM 386 Integrated Circuit

SPK: Speaker

Misc: Battery snap, breadboard, wires.

Figure 1

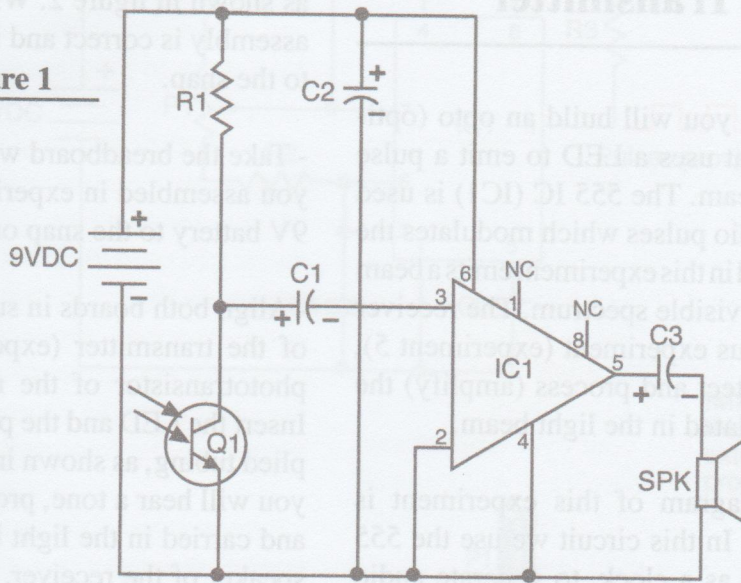
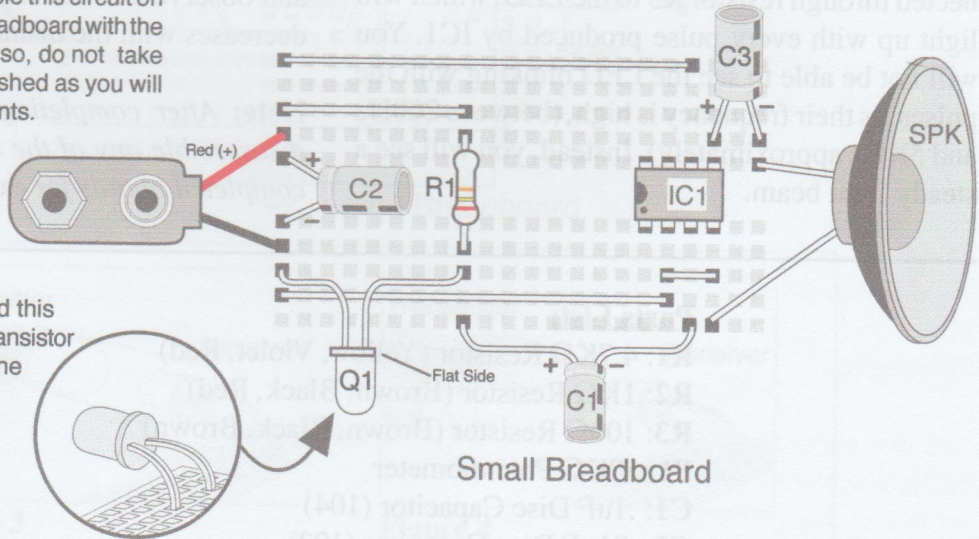

Figure 2

NOTE: Be sure to assemble this circuit on the small bread board (breadboard with the least amount of rows). Also, do not take this circuit apart when finished as you will use it with later experiments.



IMPORTANT NOTE: Build this project so that the photo transistor extends over the side of the protoboard as shown.

Experiment 6-

Opto Transmitter

In this experiment you will build an opto (optical) transmitter that uses a LED to emit a pulse modulated light beam. The 555 IC (IC1) is used to generate the audio pulses which modulates the light. The LED used in this experiment emits a beam of light within the visible spectrum. The receiver built in the previous experiment (experiment 5), will be used to detect and process (amplify) the information modulated in the light beam.

The schematic diagram of this experiment is shown in figure 1. In this circuit we use the 555 IC timer, working as a clock, to generate audio pulses. The frequency of the pulses is controlled by the values of R1, P1, R2, and C1, and it can be adjusted with potentiometer P1. The larger these values, the lower the frequency of the pulses, and viceversa. Capacitor C2 is connected between pin 5 and negative to add frequency stability to the circuit. The output of the 555 IC, pin 3, is connected through resistor R3 to the LED, which will light up with every pulse produced by IC1. You will not be able to see the LED blinking with the pulses, as their frequency is high, (between 200Hz and 5KHz approximately). Instead, you will see a steady light beam.

Procedure:

- Assemble the circuit of this experiment according to figures 1 and 2. Be sure to install the IC, and the flat side of the LED in the correct direction, as shown in figure 2. When done, verify that the assembly is correct and install a fresh 9V battery to the snap.

- Take the breadboard with the opto receiver that you assembled in experiment 5. Connect a fresh 9V battery to the snap on it.

- Align both boards in such manner that the LED of the transmitter (experiment 6) is facing the phototransistor of the receiver (experiment 5). Insert the LED and the phototransistor in the supplied tubing, as shown in figure 3. As you do this, you will hear a tone, produced by the transmitter and carried in the light beam, reproduced by the speaker of the receiver. Adjust potentiometer P1 to vary the frequency of the tone.

- Remove the tubing and observe the circuit operation through open air, as shown in figure 4. Interrupt the light beam with a piece of paper and observe how the transmission stops. Remove the paper and separate the transmitter and receiver and observe how the intensity of the audio signal decreases with the distance.

Note: After completing this experiment do not disassemble any of the boards as you need both completed boards for experiment 7.

Parts List:

R1: 4.7K Ω Resistor (Yellow, Violet, Red)

R2: 1K Ω Resistor (Brown, Black, Red)

R3: 100 Ω Resistor (Brown, Black, Brown)

P1: 50K Ω Potentiometer

C1: .1uF Disc Capacitor (104)

C2: .01uF Disc Capacitor (103)

IC1: 555 IC

L1: Clear LED with mark on the case

Misc: Battery snap, breadboard, wires, piece of plastic tube, and assembled experiment 5.

Figure 1

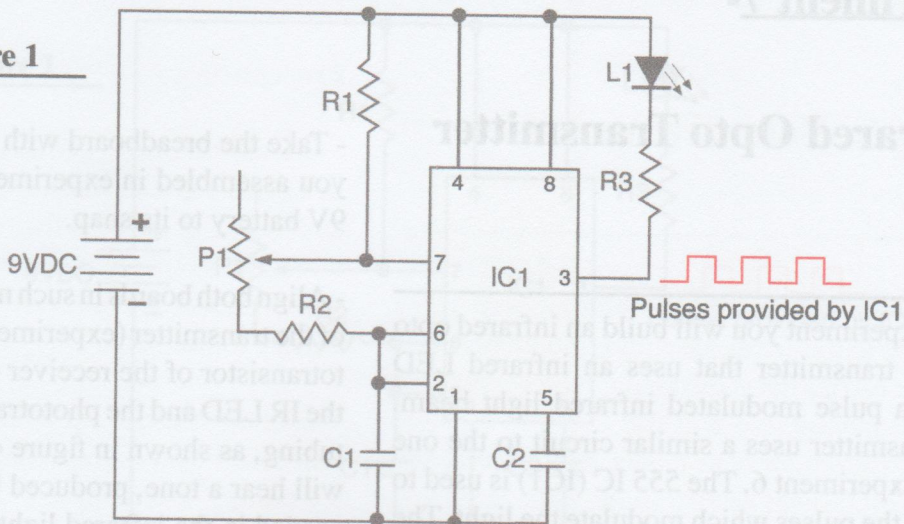

IMPORTANT NOTE: Build this project so that the LED extends over the end of the protoboard as shown below.

Figure 2

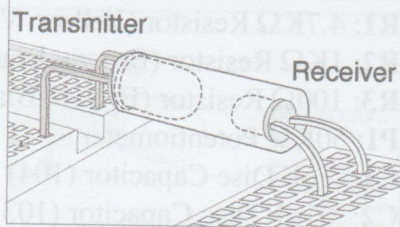
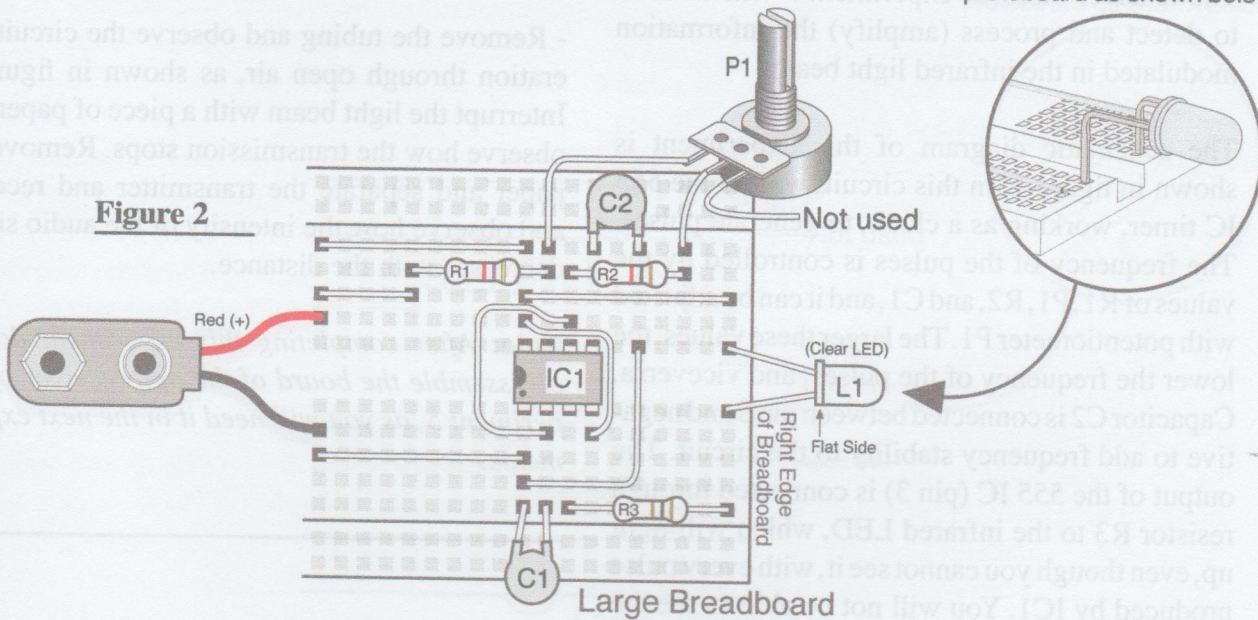

Figure 3

Use the supplied tubing to align the transmitter (Exp. 6) and receiver (Exp. 5) circuits.

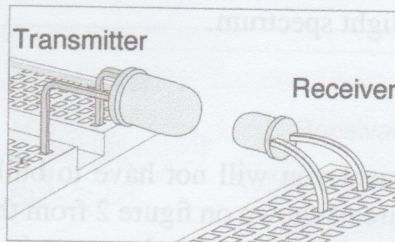

Figure 4

Remove tubing and observe circuit operation through open air.

Experiment 7-

Infrared Opto Transmitter

In this experiment you will build an infrared opto (optical) transmitter that uses an infrared LED to emit a pulse modulated infrared light beam. This transmitter uses a similar circuit to the one used in experiment 6. The 555 IC (IC1) is used to generate the pulses which modulate the light. The infrared LED used in this experiment, emits an infrared beam of light that your eyes can not see. The receiver built for experiment 5 will be used to detect and process (amplify) the information modulated in the infrared light beam.

The schematic diagram of this experiment is shown in figure 1. In this circuit, we use the 555 IC timer, working as a clock, to generate pulses. The frequency of the pulses is controlled by the values of R1, P1, R2, and C1, and it can be adjusted with potentiometer P1. The larger these values, the lower the frequency of the pulses, and viceversa. Capacitor C2 is connected between pin 5 and negative to add frequency stability to the circuit. The output of the 555 IC (pin 3) is connected through resistor R3 to the infrared LED, which will light up, even though you cannot see it, with every pulse produced by IC1. You will not be able to see the light emitted by the LED as human eyes can not see the infrared light spectrum.

Procedure:

- In this experiment you will not have to build the transmitter circuit shown on figure 2 from the beginning. Instead, you can modify the transmitter you built in experiment 6 by replacing the clear LED with the infrared LED. Notice the location of the marked side of the IR LED shown in figure 2. When done, connect a fresh 9V battery to the transmitter. You will not be able to see the light from the LED, as it is in the infrared spectrum.

- Take the breadboard with the opto receiver that you assembled in experiment 5. Connect a fresh 9V battery to its snap.

- Align both boards in such manner that the IR LED of the transmitter (experiment 7) is facing the phototransistor of the receiver (experiment 5). Insert the IR LED and the phototransistor in the supplied tubing, as shown in figure 4. As you do this, you will hear a tone, produced by the transmitter and carried in the infrared light beam, reproduced by the speaker of the receiver. Adjust potentiometer P1 to vary the frequency of the tone.

- Remove the tubing and observe the circuit operation through open air, as shown in figure 5. Interrupt the light beam with a piece of paper and observe how the transmission stops. Remove the paper and separate the transmitter and receiver and observe how the intensity of the audio signal decreases with the distance.

Note: After completing this experiment do not disassemble the board of the optoreceiver of experiment 5, as you will need it in the next experiments.

Parts List:

- R1:** 4.7K Ω Resistor (Yellow, Violet, Red)
- R2:** 1K Ω Resistor (Brown, Black, Red)
- R3:** 100 Ω Resistor (Brown, Black, Brown)
- P1:** 50K Ω Potentiometer
- C1:** .1 μ F Disc Capacitor (104)
- C2:** .01 μ F Disc Capacitor (103)
- IC1:** 555 IC
- L1:** Infrared LED (smoked LED)
- Misc:** Battery snap, breadboard, wires, piece of plastic tube, and assembled experiment 5.

Figure 1

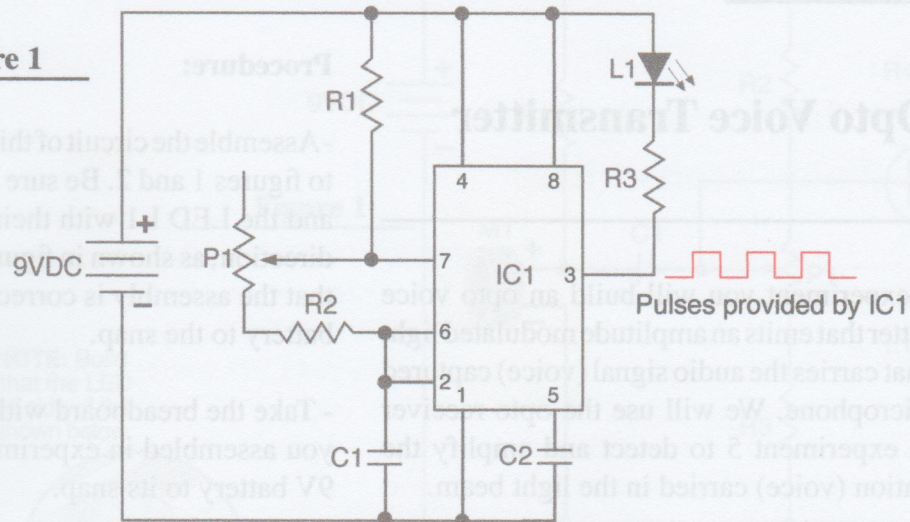

IMPORTANT NOTE: Build this project so that the LED extends over the end of the protoboard as shown below.

Figure 2

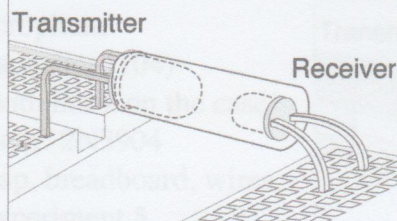
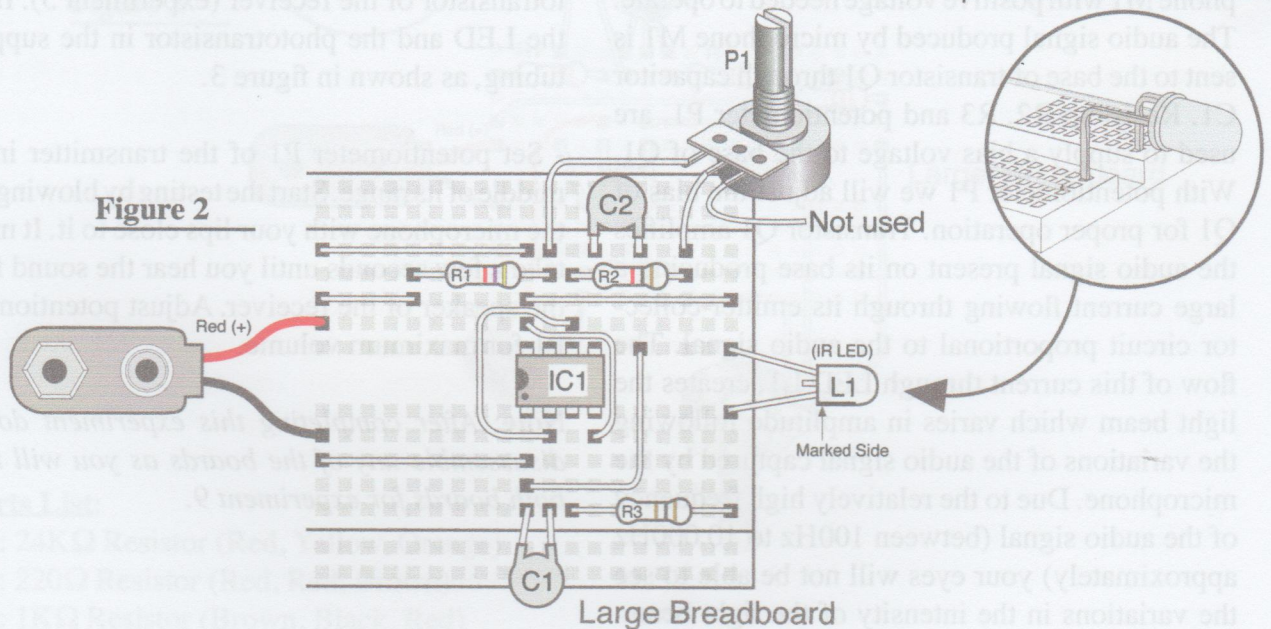

Figure 3

Use the supplied tubing to align the transmitter (Exp. 7) and receiver (Exp. 5) circuits.

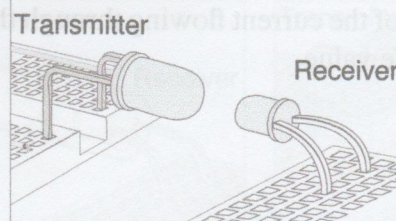

Figure 4

Remove tubing and observe circuit operation through open air.

Experiment 8-

Opto Voice Transmitter

In this experiment you will build an opto voice transmitter that emits an amplitude modulated light beam that carries the audio signal (voice) captured by a microphone. We will use the opto receiver built in experiment 5 to detect and amplify the information (voice) carried in the light beam.

The schematic diagram of this experiment is shown in figure 1. Resistor R1 supplies the electret microphone M1 with positive voltage needed to operate. The audio signal produced by microphone M1 is sent to the base of transistor Q1 through capacitor C1. Resistors R2, R3 and potentiometer P1, are used to supply a bias voltage to the base of Q1. With potentiometer P1 we will adjust the bias of Q1 for proper operation. Transistor Q1 amplifies the audio signal present on its base producing a large current flowing through its emitter-collector circuit proportional to the audio signal. The flow of this current through LED L1, creates the light beam which varies in amplitude following the variations of the audio signal captured by the microphone. Due to the relatively high frequency of the audio signal (between 100Hz to 10,000Hz approximately) your eyes will not be able to see the variations in the intensity of the light beam. All you will see is a steady light beam going from the transmitter to the receiver. Finally, resistor R4 limits the value of the current flowing through the LED L1 to a safe value.

Procedure:

- Assemble the circuit of this experiment according to figures 1 and 2. Be sure to install transistor Q1 and the LED L1 with their flat side in the proper direction, as shown in figure 2. When done, verify that the assembly is correct and install a fresh 9V battery to the snap.
- Take the breadboard with the opto receiver that you assembled in experiment 5. Connect a fresh 9V battery to its snap.
- Align both boards in such manner that the LED of the transmitter (experiment 8) is facing the phototransistor of the receiver (experiment 5). Insert the LED and the phototransistor in the supplied tubing, as shown in figure 3.
- Set potentiometer P1 of the transmitter in the middle of its range. Start the testing by blowing into the microphone with your lips close to it. It might take a few seconds until you hear the sound from the speaker of the receiver. Adjust potentiometer P1 for maximum volume.

Note: After completing this experiment do not disassemble any of the boards as you will need both boards for experiment 9.

Figure 1

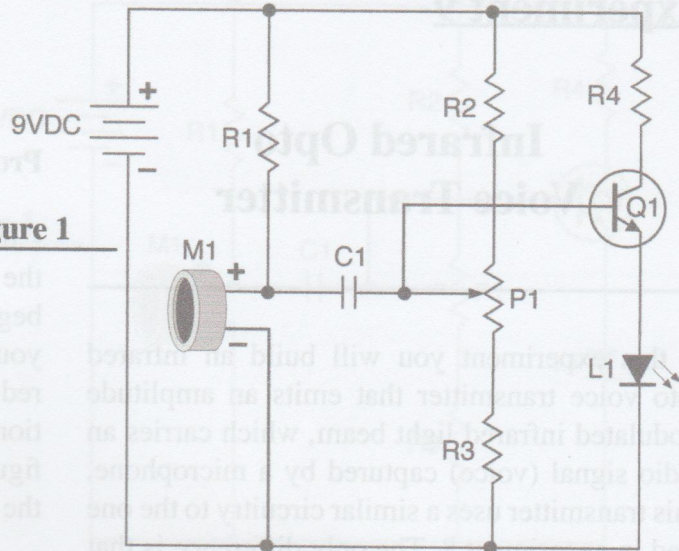

IMPORTANT NOTE: Build this project so that the LED extends over the side of the protoboard as shown below.

Figure 2

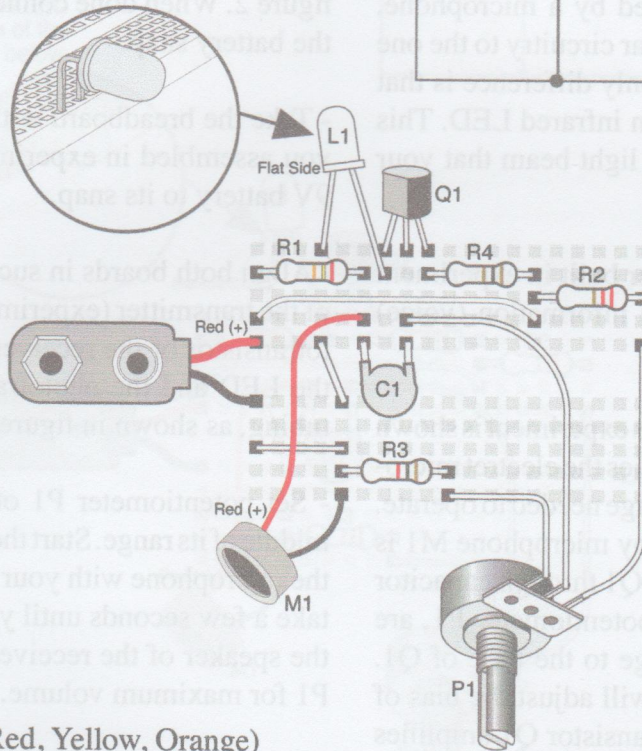

Parts List:

- R1:** 24KΩ Resistor (Red, Yellow, Orange)
- R2:** 220Ω Resistor (Red, Red, Brown)
- R3:** 1KΩ Resistor (Brown, Black, Red)
- R4:** 100Ω Resistor (Brown, Black, Brown)
- P1:** 50KΩ Potentiometer
- M1:** Electret Microphone
- C1:** .1uF Disc Capacitor (104)
- L1:** Clear LED with mark on the case
- Q1:** NPN Transistor: 2N3904
- Misc:** Battery snap, breadboard, wires, and assembled experiment 5.

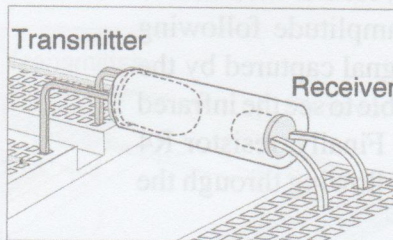

Figure 3

Use the supplied tubing to align the transmitter (Exp. 8) and receiver (Exp. 5) circuits.

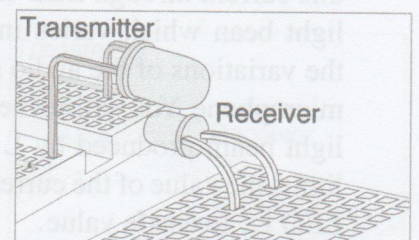

Figure 4

NOTE: You may have to place the LEDs on top of each other like this.

Experiment 9-

Infrared Opto Voice Transmitter

In this experiment you will build an infrared opto voice transmitter that emits an amplitude modulated infrared light beam, which carries an audio signal (voice) captured by a microphone. This transmitter uses a similar circuitry to the one used in experiment 8. The only difference is that in this experiment we use an infrared LED. This LED produces an infrared light beam that your eyes will not be able to see.

We will use the opto receiver built in experiment 5 to detect and amplify the information (voice) carried in the light beam.

The schematic diagram of this experiment is shown in figure 1. Resistor R1 supplies the electret microphone M1 with positive voltage needed to operate. The audio signal produced by microphone M1 is sent to the base of transistor Q1 through capacitor C1. Resistors R2, R3 and potentiometer P1, are used to supply a bias voltage to the base of Q1. With potentiometer P1 we will adjust the bias of Q1 for proper operation. Transistor Q1 amplifies the audio signal present on its base producing a large current flowing through its emitter-collector circuit proportional to the audio signal. The flow of this current through LED L1, creates the infrared light beam which varies in amplitude following the variations of the audio signal captured by the microphone. You will not be able to see the infrared light beam produced by L1. Finally, resistor R4 limits the value of the current flowing through the LED L1 to a safe value.

Procedure:

- In this experiment you will not have to build the transmitter circuit shown in figure 2 from the beginning. Instead, you can modify the transmitter you built in experiment 8 by replacing the clear red LED with the infrared LED. Notice the location of the marked side of the IR LED shown in figure 2. When done connect a fresh 9V battery to the battery snap.

- Take the breadboard with the opto receiver that you assembled in experiment 5. Connect a fresh 9V battery to its snap.

- Align both boards in such manner that the LED of the transmitter (experiment 9) is facing the phototransistor of the receiver (experiment 5). Insert the LED and the phototransistor in the supplied tubing, as shown in figure 3.

- Set potentiometer P1 of the transmitter in the middle of its range. Start the testing by blowing into the microphone with your lips close to it. It might take a few seconds until you hear the sound from the speaker of the receiver. Adjust potentiometer P1 for maximum volume.

Note: After completing this experiment do not disassemble the board of the optoreceiver of experiment 5, as you will need it in the next experiments.

Figure 1

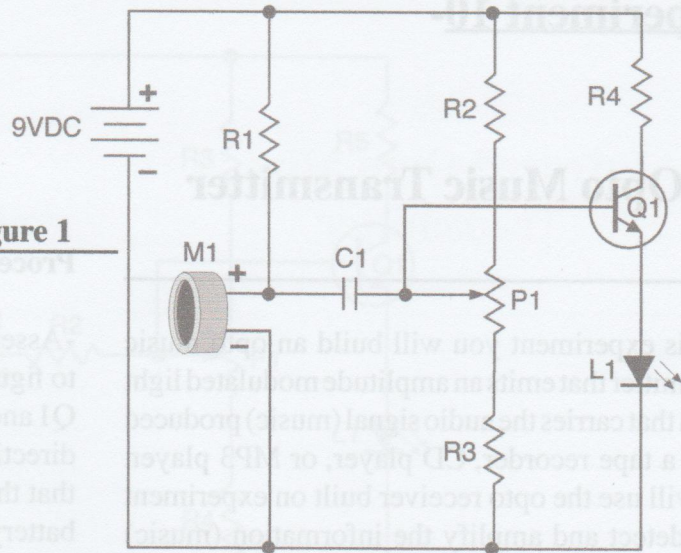

IMPORTANT NOTE: Build this project so that the LED extends over the side of the protoboard as shown below.

Figure 2

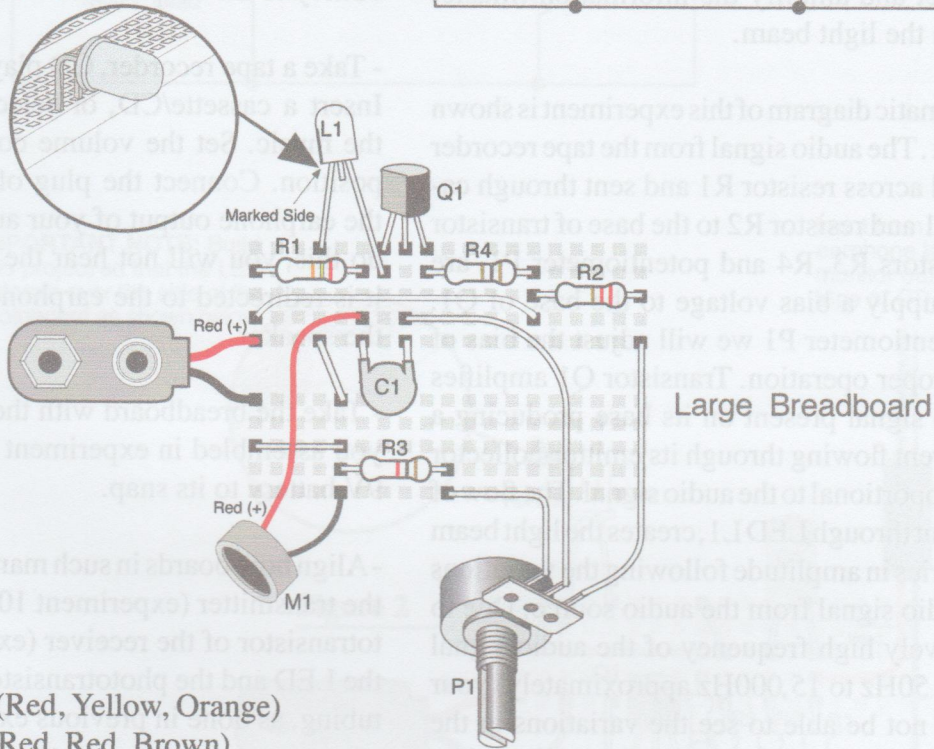

Parts List:

- R1:** 24KΩ Resistor (Red, Yellow, Orange)
- R2:** 220Ω Resistor (Red, Red, Brown)
- R3:** 1KΩ Resistor (Brown, Black, Red)
- R4:** 100Ω Resistor (Brown, Black, Brown)
- P1:** 50KΩ Potentiometer
- M1:** Electret Microphone
- C1:** .1uF Disc Capacitor (104)
- L1:** Infrared LED (smoked LED)
- Q1:** NPN Transistor: 2N3904
- Misc:** Battery snap, breadboard, wires, and assembled experiment 5.

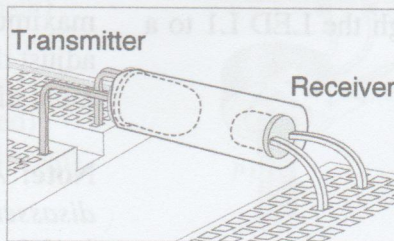

Figure 3

Use the supplied tubing to align the transmitter (Exp. 9) and receiver (Exp. 5) circuits.

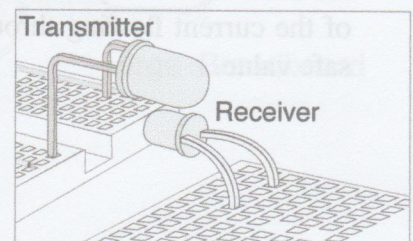

Figure 4

NOTE: You may have to place the LEDs on top of each other like this.

Experiment 10-

Opto Music Transmitter

In this experiment you will build an opto music transmitter that emits an amplitude modulated light beam that carries the audio signal (music) produced from a tape recorder, CD player, or MP3 player. We will use the opto receiver built on experiment 5 to detect and amplify the information (music) carried in the light beam.

The schematic diagram of this experiment is shown in figure 1. The audio signal from the tape recorder is applied across resistor R1 and sent through capacitor C1 and resistor R2 to the base of transistor Q1. Resistors R3, R4 and potentiometer P1, are used to supply a bias voltage to the base of Q1. With potentiometer P1 we will adjust the bias of Q1 for proper operation. Transistor Q1 amplifies the audio signal present on its base producing a large current flowing through its emitter-collector circuit proportional to the audio signal. The flow of this current through LED L1, creates the light beam which varies in amplitude following the variations of the audio signal from the audio source. Due to the relatively high frequency of the audio signal (between 50Hz to 15,000Hz approximately) your eyes will not be able to see the variations in the intensity of the light beam. All you will see is a steady light beam going from the transmitter to the receiver. Finally, resistor R5 limits the value of the current flowing through the LED L1 to a safe value.

Procedure:

- Assemble the circuit of this experiment according to figures 1 and 2. Be sure to install the transistor Q1 and the LED L1 with their flat side in the proper direction, as shown in figure 2. When done, verify that the assembly is correct and install a fresh 9V battery to the snap.

- Take a tape recorder, CD player, or MP3 player. Insert a cassette/CD, or select a song and play the music. Set the volume control to its middle position. Connect the plug of the transmitter to the earphone output of your audio source, as you do this, you will not hear the music anymore as it is redirected to the earphone output instead of the speaker.

- Take the breadboard with the opto receiver that you assembled in experiment 5. Connect a fresh 9V battery to its snap.

- Align both boards in such manner that the LED of the transmitter (experiment 10) is facing the phototransistor of the receiver (experiment 5). Insert the LED and the phototransistor into the supplied tubing, as done in previous experiments.

- Set potentiometer P1 of the transmitter in the middle of its range. Adjust potentiometer P1 for maximum volume and minimum distortion. Also adjust the volume control on the player for minimum distortion.

Note: After completing this experiment do not disassemble any of the boards as you will need both boards for experiment 11.

Figure 1

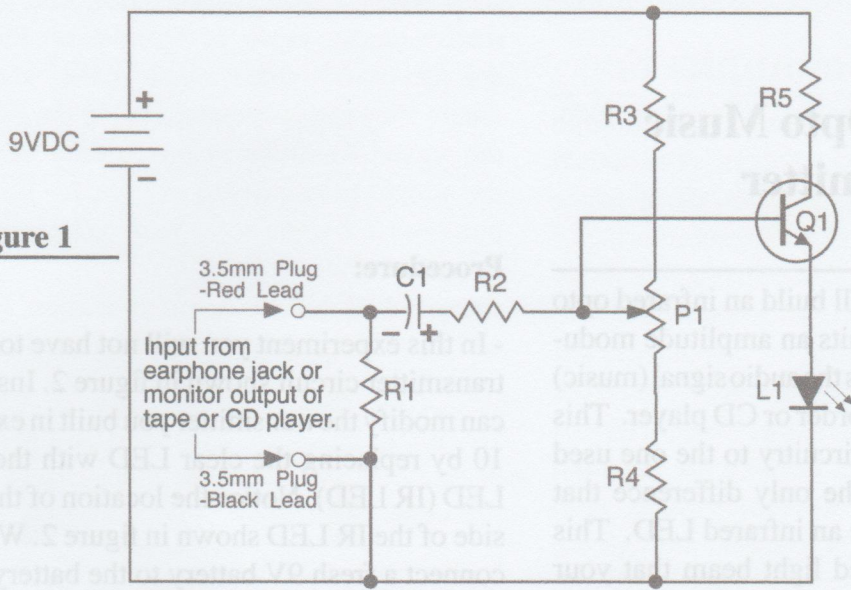

IMPORTANT NOTE: Build this project so that the LED extends over the side of the protoboard as shown below.

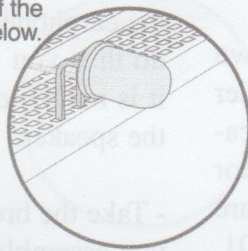
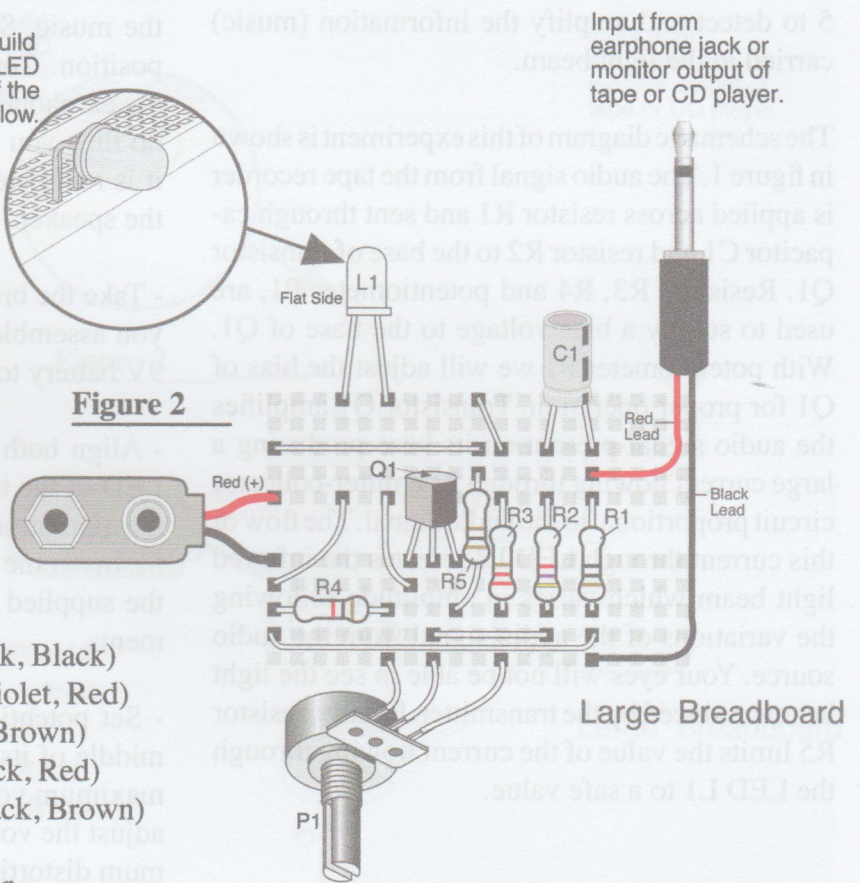

Figure 2



Parts List:

- R1:** 10Ω Resistor (Brown, Black, Black)
- R2:** 4.7KΩ Resistor (Yellow, Violet, Red)
- R3:** 220Ω Resistor (Red, Red, Brown)
- R4:** 1KΩ Resistor (Brown, Black, Red)
- R5:** 100Ω Resistor (Brown, Black, Brown)
- P1:** 50KΩ Potentiometer
- C1:** 4.7uF Electrolytic Capacitor
- L1:** Clear LED with mark on the case
- Q1:** NPN Transistor: 2N3904
- Misc.:** Battery snap, earphone plug, breadboard, wires, and assembled experiment 5.

Experiment 11-

Infrared Opto Music Transmitter

In this experiment you will build an infrared opto music transmitter that emits an amplitude modulated light beam that carries the audio signal (music) produced from a tape recorder or CD player. This transmitter uses similar circuitry to the one used in experiment 10, with the only difference that in this experiment we use an infrared LED. This LED produces an infrared light beam that your eyes will not be able to see.

We will use the opto receiver built on experiment 5 to detect and amplify the information (music) carried in the light beam.

The schematic diagram of this experiment is shown in figure 1. The audio signal from the tape recorder is applied across resistor R1 and sent through capacitor C1 and resistor R2 to the base of transistor Q1. Resistors R3, R4 and potentiometer P1, are used to supply a bias voltage to the base of Q1. With potentiometer P1 we will adjust the bias of Q1 for proper operation. Transistor Q1 amplifies the audio signal present on its base producing a large current flowing through its emitter-collector circuit proportional to the audio signal. The flow of this current through LED L1, creates the infrared light beam which varies in amplitude following the variations of the audio signal from the audio source. Your eyes will not be able to see the light beam produced by the transmitter. Finally, resistor R5 limits the value of the current flowing through the LED L1 to a safe value.

Procedure:

- In this experiment you will not have to build the transmitter circuit shown in figure 2. Instead, you can modify the transmitter you built in experiment 10 by replacing the clear LED with the infrared LED (IR LED). Notice the location of the marked side of the IR LED shown in figure 2. When done connect a fresh 9V battery to the battery snap.

- Take a tape recorder, CD player, or MP3 player. Insert a cassette/CD, or select a song and play the music. Set the volume control to its middle position. Connect the plug of the transmitter to the earphone output of your audio source, as you do this, you will not hear the music anymore as it is redirected to the earphone output instead of the speaker.

- Take the breadboard with the opto receiver that you assembled in experiment 5. Connect a fresh 9V battery to the snap.

- Align both boards in such manner that the IR LED of the transmitter (experiment 11) is facing the phototransistor of the receiver (experiment 5). Insert the IR LED and the phototransistor into the supplied tubing, as done in previous experiments.

- Set potentiometer P1 of the transmitter in the middle of its range. Adjust potentiometer P1 for maximum volume and minimum distortion. Also adjust the volume control on the player for minimum distortion.

Note: After completing this experiment do not disassemble the receiver of experiment 5 as you will need it in future experiments.

Figure 1

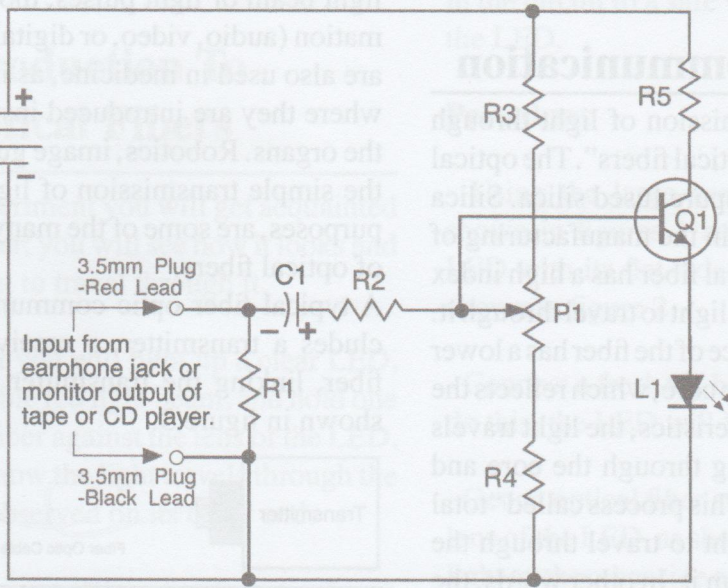

IMPORTANT NOTE: Build this project so that the LED extends over the side of the protoboard as shown below.

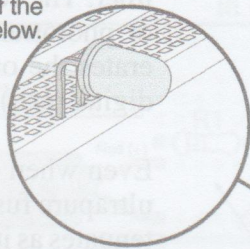

Input from earphone jack or monitor output of tape or CD player.

Figure 2

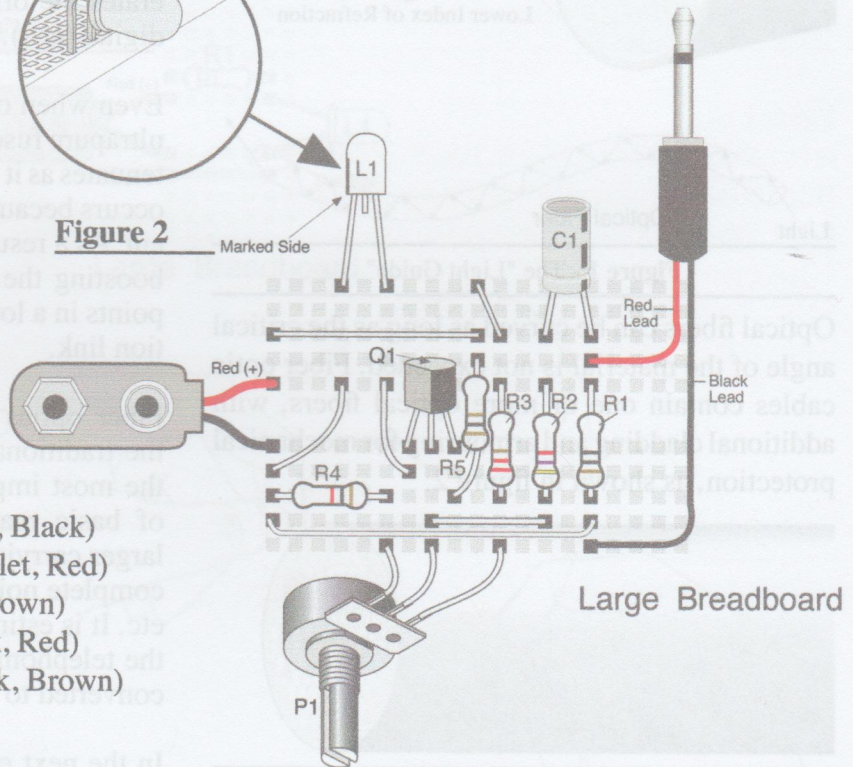

Parts List:

- R1:** 10Ω Resistor (Brown, Black, Black)
- R2:** 4.7KΩ Resistor (Yellow, Violet, Red)
- R3:** 220Ω Resistor (Red, Red, Brown)
- R4:** 1KΩ Resistor (Brown, Black, Red)
- R5:** 100Ω Resistor (Brown, Black, Brown)
- P1:** 50KΩ Potentiometer
- C1:** 4.7uF Electrolytic Capacitor
- L1:** Infrared LED (smoked LED)
- Q1:** NPN Transistor: 2N3904
- Misc.:** Battery snap, earphone plug, breadboard, wires, and assembled experiment 5.

Lesson 6-

Fiber Optics Communication

Fiber optics is the transmission of light through thin glass fibers called "optical fibers". The optical fibers are made from ultrapure fused silica. Silica is the main material used in the manufacturing of glass. The core of an optical fiber has a high index of refraction, allowing the light to travel through it. The surroundings or surface of the fiber has a lower index of refraction than the core, which reflects the light. Due to these characteristics, the light travels through the fiber by going through the core and bouncing on the surface. This process called "total reflection", allows the light to travel through the fiber without escaping from it. In other words, the optical fiber acts as a "guide" or "channel" for the light to travel through it. See figure 1.

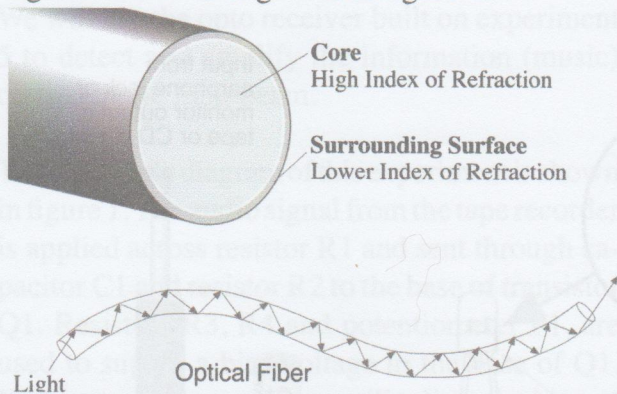

Figure 1 - The "Light Guide"

Optical fibers can be curved as long as the critical angle of the material is not exceeded. Fiber optic cables contain one or more optical fibers, with additional cladding and armoring for mechanical protection, as shown in figure 2.

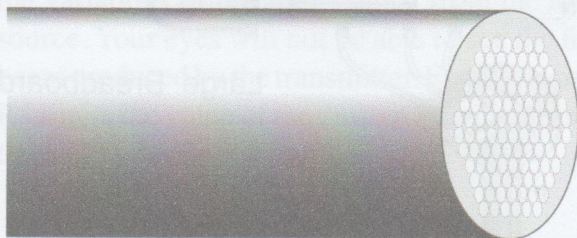

Figure 2 - Multiple Fiber Cable

Fiber optic technology has many scientific and commercial applications. Electronic communications is the most important technology of all

of them, where optical fibers are used to carry a light beam or light pulses, modulated with information (audio, video, or digital data). Fiber optics are also used in medicine, as in the "endoscope", where they are introduced inside the body to see the organs. Robotics, image guiding, sensing, and the simple transmission of light for illumination purposes, are some of the many other applications of optical fibers.

A typical fiber optic communication system includes a transmitter, a receiver, and an optical fiber, linking the transmitter to the receiver, as shown in figure 3.

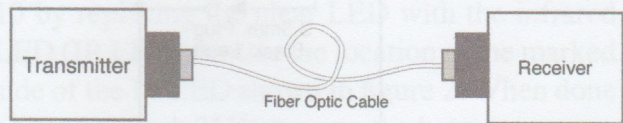

Figure 3 - Typical Fiber Optics Communication System

The transmitter, which includes a laser or light emitting diode (LED), sends a light beam or pulses, modulated with information, through the optical fiber. The receiver, which contains a photodiode or phototransistor, detects, amplifies and regenerates the original information (audio, video, or digital data).

Even when optical fibers are manufactured from ultrapure fused silica, the light still weakens or attenuates as it travels through the fiber. This mainly occurs because the fiber is not perfectly transparent. As a result of this attenuation reamplifying or boosting the light needs to be done at different points in a long distance fiber optics communication link.

Fiber optics links have many advantages over the traditional copper wire connections. Among the most important we can mention: lower cost of basic materials, lower transmission losses, larger carrying capacity (more channels), almost complete noise immunity, smaller size of cables, etc. It is estimated that in the near future most of the telephonic and television cable links will be converted to fiber optic technology.

In the next experiments you will get acquainted with optical fibers. You will observe how they look, and how light travels through them. You will also build a simple fiber optic communication system which includes a transmitter, the optical fiber link, and the receiver.

Experiment 12-

Introduction To Optical Fibers

In this simple experiment you will get acquainted with an optical fiber; you will see how it looks and how it allows light to travel through it.

In this experiment you will light up a clear LED, which emits a visible red light beam, and hold one end of an optical fiber against the lens of the LED. You will observe how the light travels through the fiber and can be observed on its other end.

The schematic diagram of this experiment is shown in figure 1. The current (I) flows in this circuit from the negative side of the battery toward the positive side, passing through the LED L1 and resistor R1. The LED lights up, as current flows

through it. Resistor R1 limits the current flowing in the circuit to a safe value that does not damage the LED.

Procedure:

- Using the large breadboard, build the circuit shown in figures 1 and 2. Be sure to install the LED with its flat side in the proper direction, as shown in figure 2.

- Connect a fresh 9V battery to the circuit. As you do this, the LED will light up.

- Get an optical fiber and hold one end against the lens of the LED, as shown in figure 3. Observe the light on the other side of the fiber. Darken the room, if possible, to have a better look of the light. Notice that you do not see the light along the fiber, but only on the end. This is due to the fact the light can not escape the fiber through its surface, as explained in lesson 6, but only through its core.

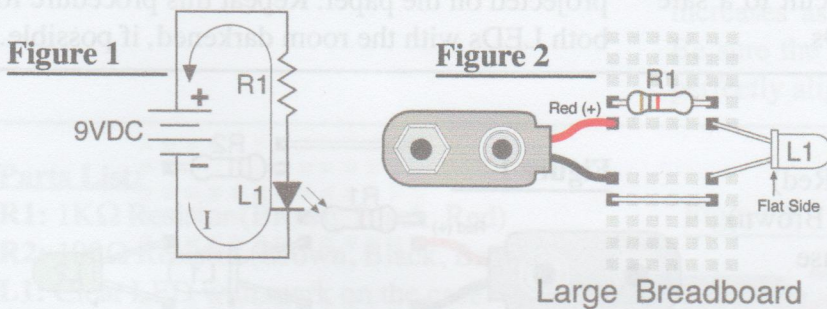
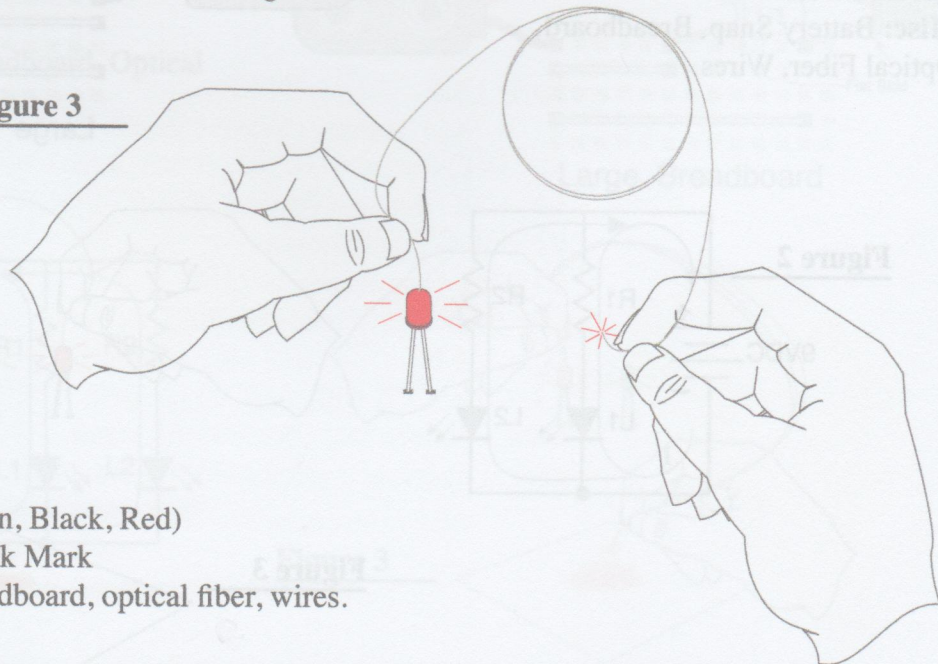

Figure 3



Parts List:

R1: 1K Ω Resistor (Brown, Black, Red)

L1: Clear LED with Black Mark

Misc.: Battery snap, breadboard, optical fiber, wires.

Experiment 13-

Fiber Optics: Dual Color Transmission

In this experiment you will observe how optical fibers can carry light of different colors. You will light up a red and a green LED and observe how the light travels through the fiber preserving its frequency (color).

The schematic diagram of this experiment is shown in figure 2. The current flows in this circuit from the negative side of the battery toward the positive side, passing through LEDs L1 and L2, and resistors R1 and R2. The LEDs light up, as current flows through them. Resistor R1 and R2 limit the current flowing in the circuit to a safe value that will not damage the LEDs.

Parts List:

R1: 1K Ω Resistor (Brown, Black, Red)

R2: 100 Ω Resistor (Brown, Black, Brown)

L1: Clear LED with mark on the case

L2: Green LED

Misc: Battery Snap, Breadboard, Optical Fiber, Wires.

Procedure:

- Using the large breadboard the circuit shown in figures 1 and 2. Be sure to install the LEDs with the flat side in the proper direction, as shown in figure 1.

- Connect a fresh 9V battery to the circuit. As you do this, the LEDs will light up.

- Take an optical fiber and hold one end against the lens of the red LED. Observe the light on the other side of the fiber.

- Move the fiber to the green LED and observe how the light is carried to the other end and the color is maintained.

- Take a white piece of paper and hold the end of the fiber close to it, as shown in figure 3. Observe how light is emitted from the end of the fiber and projected on the paper. Repeat this procedure for both LEDs with the room darkened, if possible.

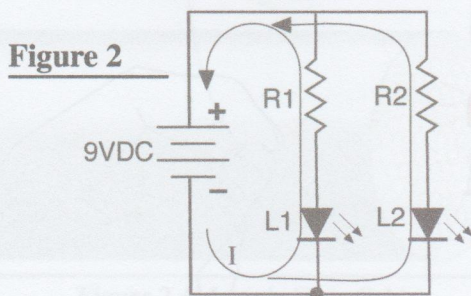
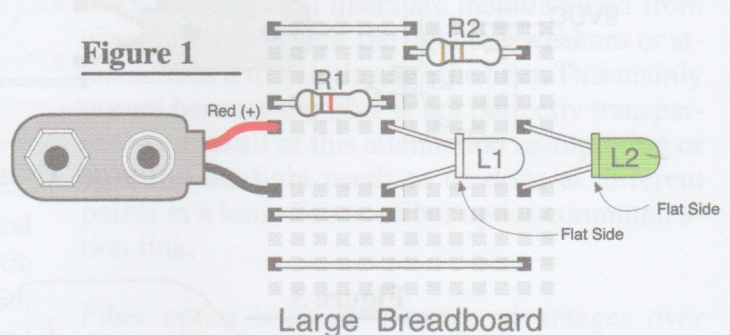
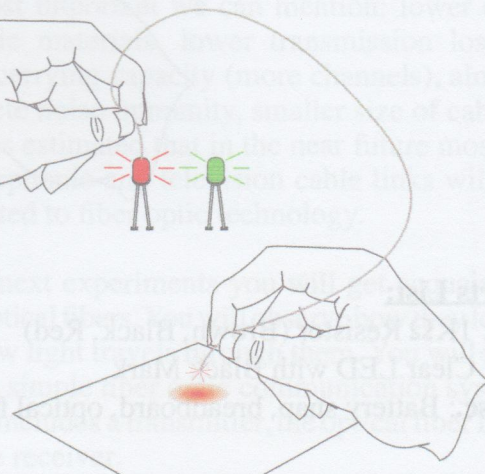

Figure 3



Experiment 14-

Fiber Optics: Multiple Fiber Transmission

In this experiment you will observe how the intensity of the transmitted light is increased by holding several fibers together. You will light up a red and a green LED and observe how the light travels through the fibers and how the intensity of the light increases as more fibers are added.

The schematic diagram of this experiment is shown in figure 2. The current flows in this circuit from the negative side of the battery toward the positive side, passing through LEDs L1 and L2, and resistors R1 and R2. The LEDs light up, as current flows through them. Resistor R1 and R2 limit the current flowing in the circuit to a safe value that will not damage the LEDs.

Parts List:

R1: 1K Ω Resistor (Brown, Black, Red)

R2: 100 Ω Resistor (Brown, Black, Brown)

L1: Clear LED with mark on the case

L2: Green LED

Misc: Battery Snap, Breadboard, Optical Fibers, Wires.

Procedure:

- For this experiment you will use the same circuit you build in the last experiment.

- Connect a fresh 9V battery to the circuit. As you do this, the LEDs will light up.

- Take an optical fiber and hold one end against the lens of the red LED. Observe the light on the other end of the fiber. Darken the room, if possible, to have a better look of the light.

- Move the fiber to the green LED and observe how the light is carried to the other end and the color is preserved.

- Take a white piece of paper and hold the end of the fiber close to it, as shown in figure 3.

- Repeat the three previous steps with two and three fibers, as shown in figure 3. Observe how the intensity of the light projected on the paper increases as the number of fibers is increased. Be sure the fibers have the same length and are perfectly aligned on both ends.

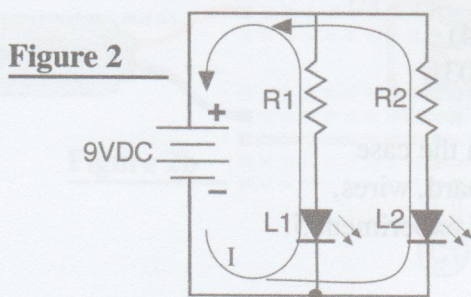
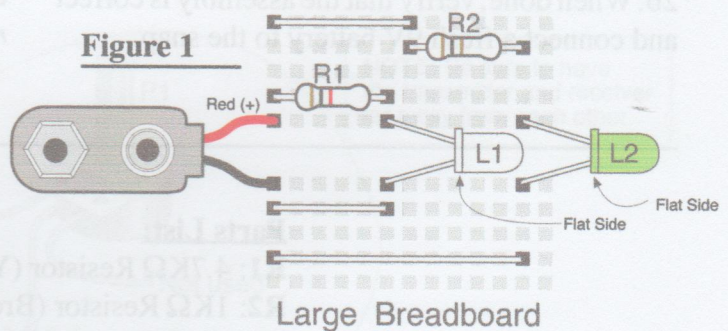
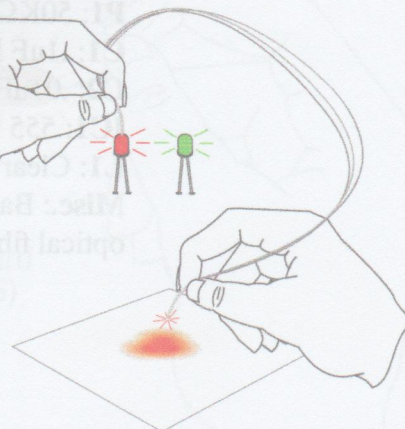

Figure 3



Experiment 15-

Fiber Optics Audio Link

In this experiment you will build an opto transmitter that emits a pulse modulated light beam. You will use an optical fiber to link this transmitter to the opto receiver of experiment 5. You will observe how the modulated light is carried through the optical fiber and detected by the receiver.

The circuit of the transmitter in this experiment is shown in Figure 1. This circuit is identical to the one built on experiment 6. Refer to experiment 6 for a complete description of the operation of the circuit.

Procedure:

- Build on the breadboard the circuit shown on figures 1 and 2b. Be sure to install the LED and the IC in the proper direction, as shown in figure 2b. When done, verify that the assembly is correct and connect a fresh 9V battery to the snap.

- Take the breadboard with the opto receiver that you assembled in experiment 5 (figure 2a). Connect a fresh 9V battery to the snap of this receiver.

- Take an optical fiber and use both hands to hold it between the transmitter and the receiver, as shown in figure 2. As you do this, you will hear the audible tone produced by the transmitter (figure 2b) from the speaker of the receiver (figure 2a).

- Repeat the above procedure using two and three fibers and observe how the intensity of the sound increases with the number of fibers. Be sure the fibers have the same length and are perfectly aligned on both ends. If necessary, you may trim the fiber(s) with a pair of scissors.

Note: When done, do not disassemble any of the circuits as you will need them in the next experiment.

Parts List:

R1: 4.7K Ω Resistor (Yellow, Violet, Red)

R2: 1K Ω Resistor (Brown, Black, Red)

R3: 100 Ω Resistor (Brown, Black, Brown)

P1: 50K Ω Potentiometer

C1: .1 μ F Disc Capacitor (104)

C2: .01 μ F Disc Capacitor (103)

IC1: 555 IC

L1: Clear LED with mark on the case

Misc.: Battery snap, breadboard, wires, optical fibers, and assembled experiment 5.

Figure 1

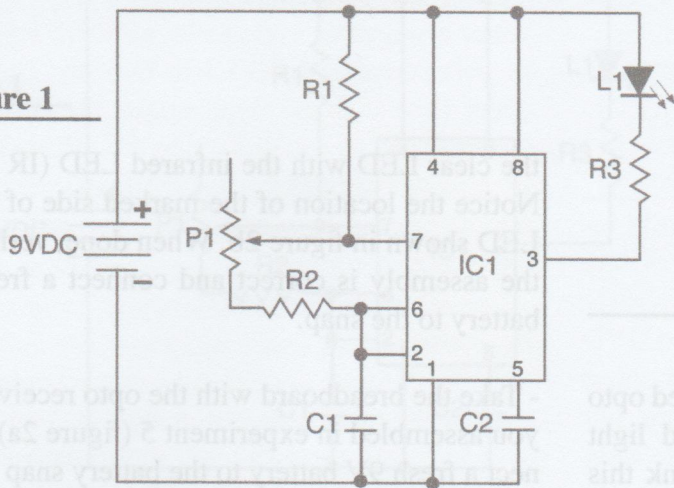
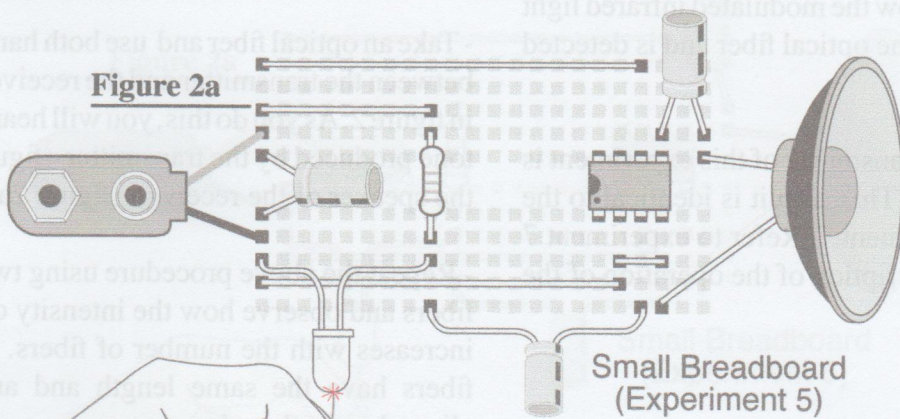

Figure 2a



Small Breadboard
(Experiment 5)

NOTE: Be sure to have the transmitter and receiver far away from each other.

Figure 2b

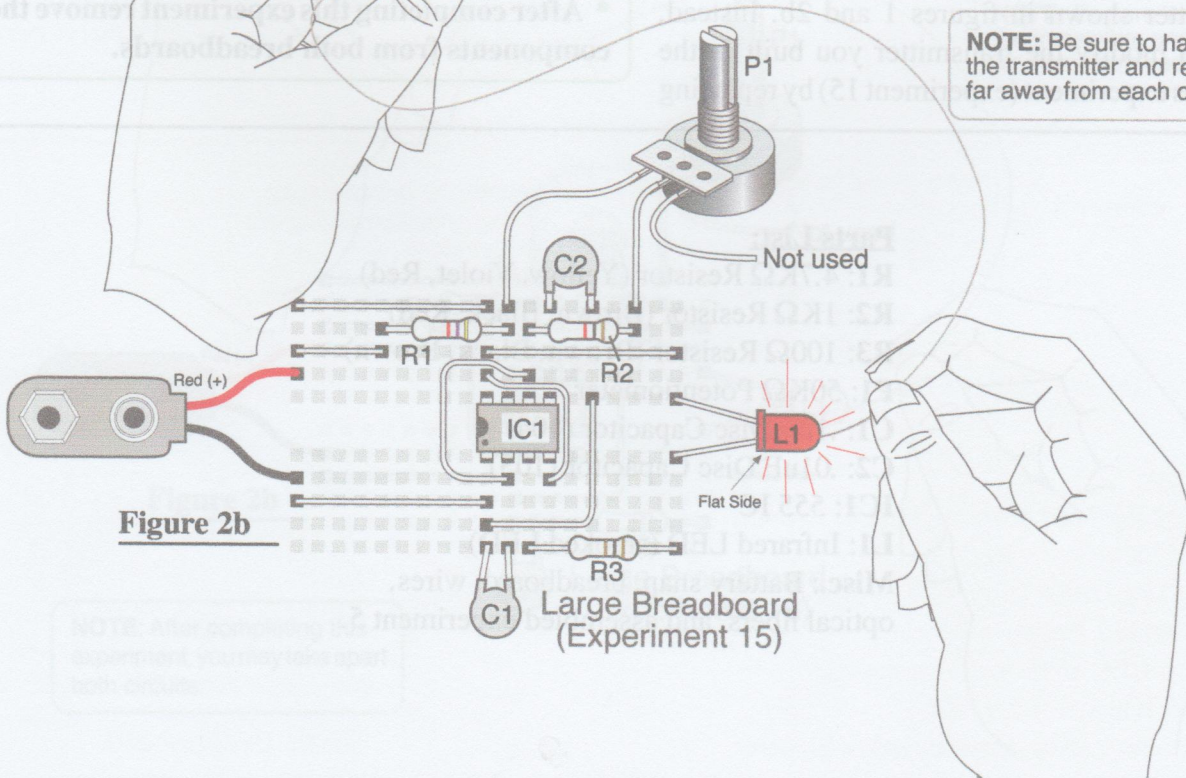

Large Breadboard
(Experiment 15)

Experiment 16-

Infrared Fiber Optic Audio Links

In this experiment you will build an infrared opto transmitter that emits a pulse modulated light beam. You will use an optical fiber to link this transmitter to the opto receiver of experiment 5. You will observe how the modulated infrared light is carried through the optical fiber and is detected by the receiver.

The circuit of the transmitter of this experiment is shown in Figure 1. This circuit is identical to the one built on experiment 7. Refer to experiment 7 for a complete description of the operation of the circuit.

Procedure:

- In this experiment you will not have to build the transmitter shown in figures 1 and 2b. Instead, you can modify the transmitter you built in the previous experiment (experiment 15) by replacing

the clear LED with the infrared LED (IR LED). Notice the location of the marked side of the IR LED shown in figure 2b. When done, verify that the assembly is correct and connect a fresh 9V battery to the snap.

- Take the breadboard with the opto receiver that you assembled in experiment 5 (figure 2a). Connect a fresh 9V battery to the battery snap of this receiver.

- Take an optical fiber and use both hands to hold it between the transmitter and the receiver, as shown in figure 2. As you do this, you will hear the audible tone produced by the transmitter (figure 2b) from the speaker of the receiver (figure 2a).

- Repeat the above procedure using two and three fibers and observe how the intensity of the sound increases with the number of fibers. Be sure the fibers have the same length and are perfectly aligned on both ends.

• After completing this experiment remove the components from both breadboards.

Parts List:

- R1:** 4.7K Ω Resistor (Yellow, Violet, Red)
- R2:** 1K Ω Resistor (Brown, Black, Red)
- R3:** 100 Ω Resistor (Brown, Black, Brown)
- P1:** 50K Ω Potentiometer
- C1:** .1 μ F Disc Capacitor (104)
- C2:** .01 μ F Disc Capacitor (103)
- IC1:** 555 IC
- L1:** Infrared LED (smoked LED)
- Misc.:** Battery snap, breadboard, wires, optical fibers, and assembled experiment 5.

Figure 1

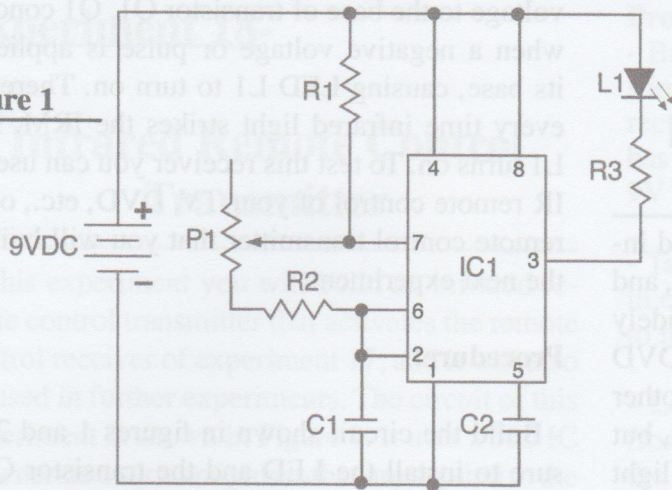
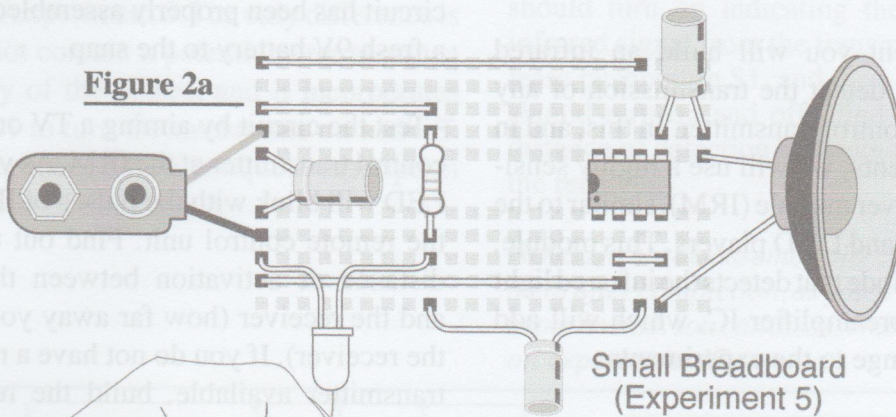

Figure 2a



**Small Breadboard
(Experiment 5)**

NOTE: Be sure to have the transmitter and receiver far away from each other.

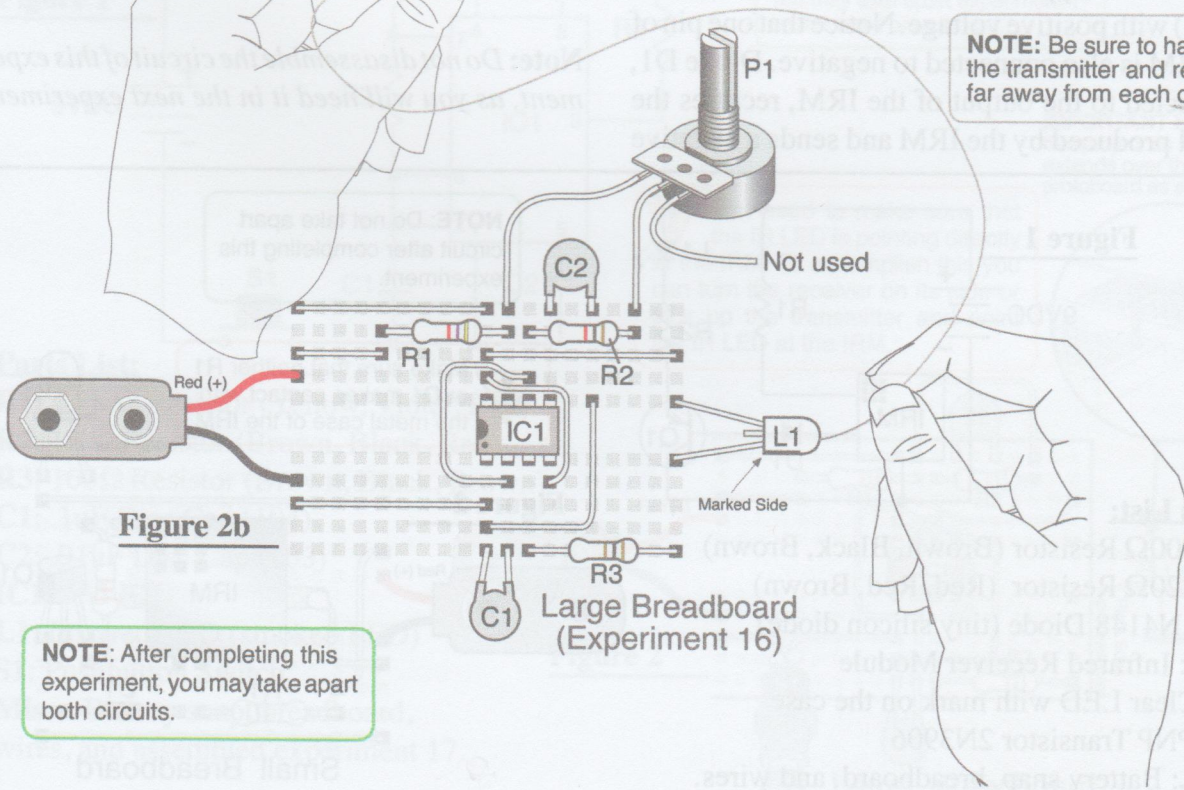

Figure 2b

**Large Breadboard
(Experiment 16)**

NOTE: After completing this experiment, you may take apart both circuits.

Experiment 17-

Infrared Remote Control Receiver

In the next seven experiments you will build infrared remote control receivers, transmitters, and proximity detectors. Infrared light (IR) is widely used in remote control applications (TV and DVD remote controls, etc.) as well as in many other applications. Your eyes can not see IR light, but it behaves in a similar manner to the visible light spectrum.

In this experiment you will build an infrared receiver that will detect the transmission of any infrared remote control transmitter. In this, and in the next experiments, we will use a highly sensitive infrared receiver module (IRM), similar to the ones used in TVs and DVD players. This module, contains a photodiode that detects the infrared light and a receiving preamplifier IC, which will add sensitivity and range to the experiments.

The circuit of this experiment is shown in Figure 1. Resistor R1 supplies the infrared receiver module (IRM) with positive voltage. Notice that one pin of the IRM is also connected to negative. Diode D1, connected to the output of the IRM, rectifies the signal produced by the IRM and sends a negative

voltage to the base of transistor Q1. Q1 conducts when a negative voltage or pulse is applied to its base, causing LED L1 to turn on. Therefore, every time infrared light strikes the IRM, LED L1 turns on. To test this receiver you can use any IR remote control of your TV, DVD, etc., or the remote control transmitter that you will build in the next experiment.

Procedure:

- Build the circuit shown in figures 1 and 2. Be sure to install the LED and the transistor Q1 in the correct direction. When done verify that the circuit has been properly assembled, and connect a fresh 9V battery to the snap.

- Test the circuit by aiming a TV or DVD remote control transmitter at the IRM. As you do this, the LED will blink with the pulses of IR light sent by the remote control unit. Find out the maximum distance of activation between the transmitter and the receiver (how far away you can activate the receiver). If you do not have a remote control transmitter available, build the remote control transmitter of the next experiment and use it to test this receiver.

Note: Do not disassemble the circuit of this experiment, as you will need it in the next experiments.

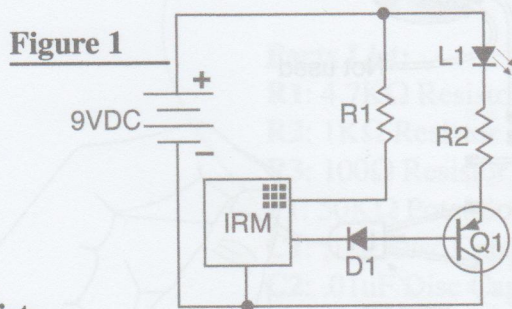

Parts List:

- R1:** 100Ω Resistor (Brown, Black, Brown)
- R2:** 220Ω Resistor (Red, Red, Brown)
- D1:** 1N4148 Diode (tiny silicon diode)
- IRM:** Infrared Receiver Module
- L1:** Clear LED with mark on the case
- Q1:** PNP Transistor 2N3906
- Misc.:** Battery snap, breadboard, and wires.

NOTE: Do not take apart circuit after completing this experiment.

! Make sure that neither R1 or D1 makes contact with the metal case of the IRM.

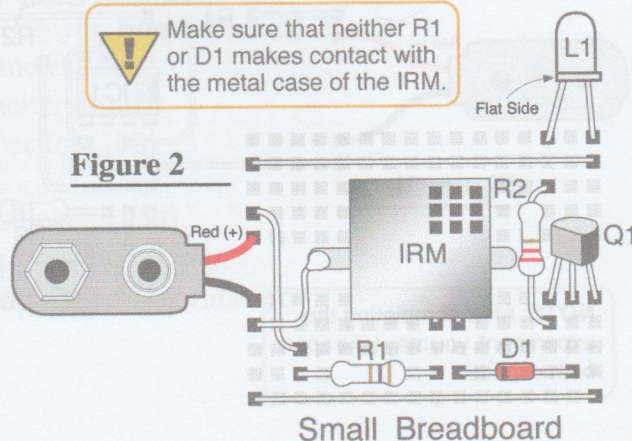

Experiment 18-

Infrared Remote Control Transmitter

In this experiment you will build an infrared remote control transmitter that activates the remote control receiver of experiment 17, and it will also be used in further experiments. The circuit of this experiment is shown in Figure 1. It uses a 555 IC to generate a series of pulses that are applied to the infrared LED L1. This circuit is similar to the opto transmitter of experiment 6. The only difference is that it does not contain a potentiometer to adjust the frequency of the pulses, and it incorporates pushbutton S1 to turn the transmitter on and off. Refer to experiment 6 for a complete description of the operation of this circuit.

Procedure:

- Build the circuit shown in figures 1 and 2. Be sure to install the IR LED L1 and IC1 in the correct direction. When done, verify that the circuit has been properly assembled, and connect a fresh 9V battery to the snap.

- Take the infrared remote control receiver built in experiment 17 and connect a fresh 9V battery to it.

- Locate the transmitter at least two feet away from the receiver. Press pushbutton S1 and aim the IR LED of the transmitter at the IRM of the receiver (experiment 17). The LED of the receiver should turn on indicating the reception of the infrared signal from the transmitter. Press and release pushbutton S1, and the LED of the receiver should turn on and off. Find out the maximum distance of detection between the transmitter and the receiver.

Note: Do not disassemble the circuit of this experiment after completion, as you will need it in further experiments. You can disassemble the receiver built on experiment 17.

Figure 1

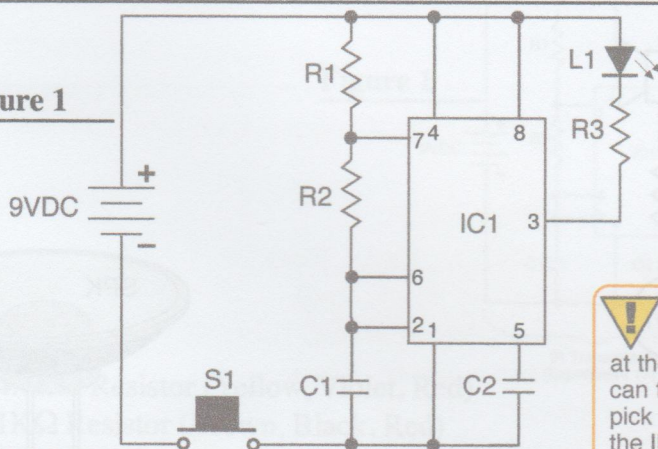

NOTE: Do not take apart circuit after completing this experiment. You may take apart experiment 17 on the small breadboard.

Parts List:

R1: 4.7K Ω Resistor (Yellow, Violet, Red)

R2: 1K Ω Resistor (Brown, Black, Red)

R3: 100 Ω Resistor (Brown, Black, Brown)

C1: .1 μ F Disc Cap (104)

C2: .01 μ F Disc Cap (103)

IC1: 555 IC

L1: Infrared LED (smoked LED)

S1: Pushbutton Switch

Misc.: Battery snap, breadboard, wires, and assembled experiment 17.

! You need to make sure that the IR LED is pointing directly at the IRM. To accomplish this you can turn the receiver on its side or pick up the transmitter and point the IR LED at the IRM.

IMPORTANT NOTE: Build this project so that the LED extends over the end of the protoboard as shown below.

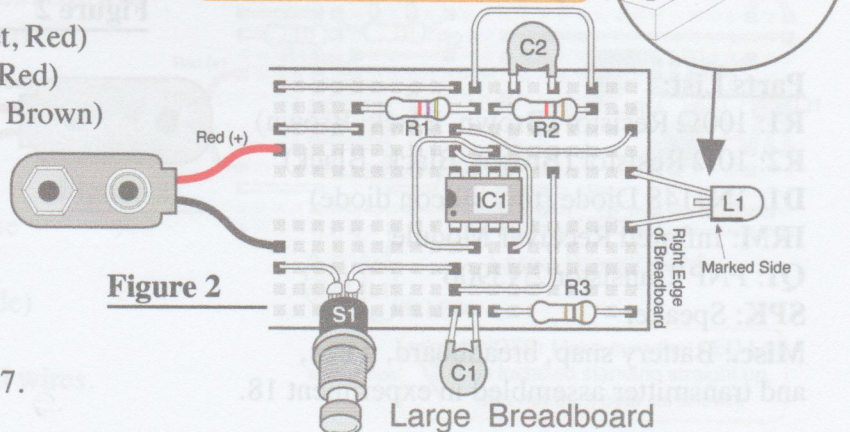

Figure 2

Large Breadboard

Experiment 19-

Audible Infrared Remote Control Receiver

In this experiment you will build a remote control receiver that emits sound, when hit by an IR signal from a remote control transmitter.

The circuit of this experiment is shown in Figure 1. Resistor R1 supplies the infrared receiver module (IRM) with positive voltage. Notice that one pin of the IRM is also connected to negative. Diode D1, connected to the output of the IRM, rectifies the signal produced by the IRM and sends a negative voltage to the base of transistor Q1. Q1 conducts when a negative voltage or pulse is applied to its base, causing the speaker SPK to emit a sound. Therefore, every time infrared light

strikes the IRM, the speaker will emit a sound. You can test this receiver with any IR remote control transmitter of your TV, DVD player, etc., or with the remote control transmitter built on experiment 18.

Procedure:

- Build the circuit shown in figures 1 and 2. Be sure to install the transistor in the correct direction. When done verify that the circuit has been properly assembled, and connect a fresh 9V battery to the snap.
- Test the circuit by aiming a TV or DVD remote control transmitter, or the transmitter of experiment 18, at the IRM. Press any button on the remote, and as you do this, the speaker will emit sound. Find out the maximum distance of activation between the transmitter and the receiver.

• After completing this experiment remove the components of both breadboards.

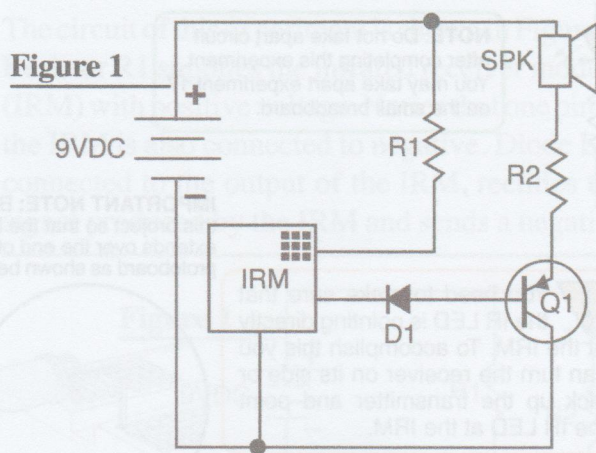

Parts List:

R1: 100Ω Resistor (Brown, Black, Brown)

R2: 10Ω Resistor (Brown, Black, Black)

D1: 1N4148 Diode (tiny silicon diode)

IRM: Infrared Receiver Module

Q1: PNP Transistor 2N3906

SPK: Speaker

Misc.: Battery snap, breadboard, wires, and transmitter assembled in experiment 18.

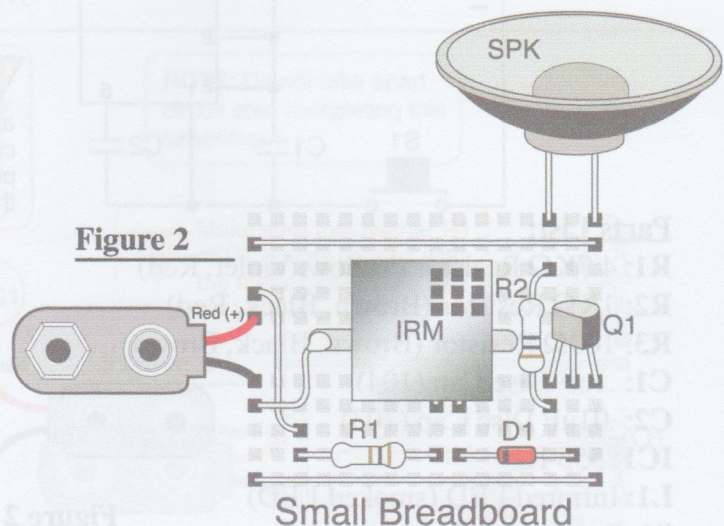

Experiment 20-

Infrared Proximity Detector

In this experiment you will build an infrared proximity detector that turns on a LED when an object gets close to it. The circuit combines the infrared transmitter of experiment 18, with the infrared detector of experiment 17. Both circuits are built on the same board.

The IR LED of the transmitter (L1), emits an IR light beam that bounces off the object and strikes the infrared receiver module (IRM) in the receiver (figure 1). If no object is near, the IR beam emitted by the transmitter will go away and will not be detected by the receiver. This proximity detector will detect objects several inches away from the IR LED.

Procedure:

- Build the circuit shown in figures 1 and 2. Be sure to install the IC, transistor and LEDs in the correct direction. Be sure that the IR LED L1 is pointing up. When done, verify that the circuit has been properly assembled, and connect a fresh 9V battery to the snap.

- Test the circuit by sliding your hand in front of and about 3 inches from the IR LED L1. As you do this, LED L2 should turn on, indicating the detection of the object, in this case your hand.

Determine the maximum distance of detection for several objects.

Note: If the LED remains on all the time, slightly bend the IR LED L1 away from the IRM module to avoid direct IR light reaching the IRM module.

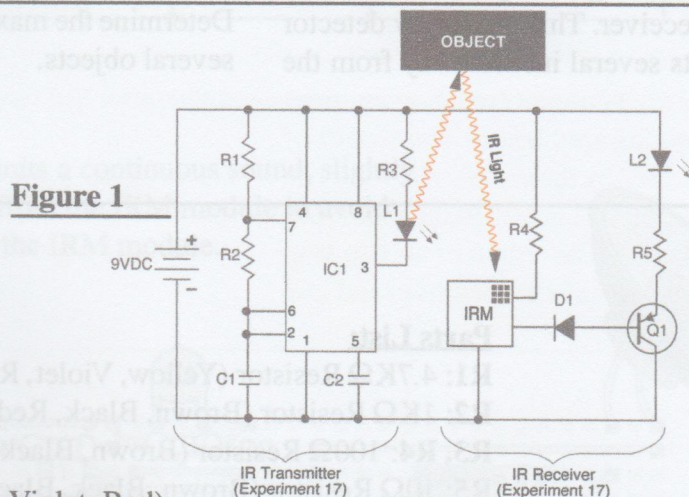

Parts List:

R1: 4.7K Ω Resistor (Yellow, Violet, Red)

R2: 1K Ω Resistor (Brown, Black, Red)

R3, R4: 100 Ω Resistor (Brown, Black, Brown)

R5: 220 Ω Resistor (Red, Red, Brown)

C1: .1 μ F Disc Capacitor (104)

C2: .01 μ F Disc Capacitor (103)

IC1: 555 IC

L1: Infrared LED (smoked LED)

L2: Clear LED with mark on the case

IRM: Infrared Receiver Module

D1: 1N4148 Diode (tiny silicon diode)

Q1: PNP Transistor 2N3906

Misc.: Battery snap, breadboard, and wires.

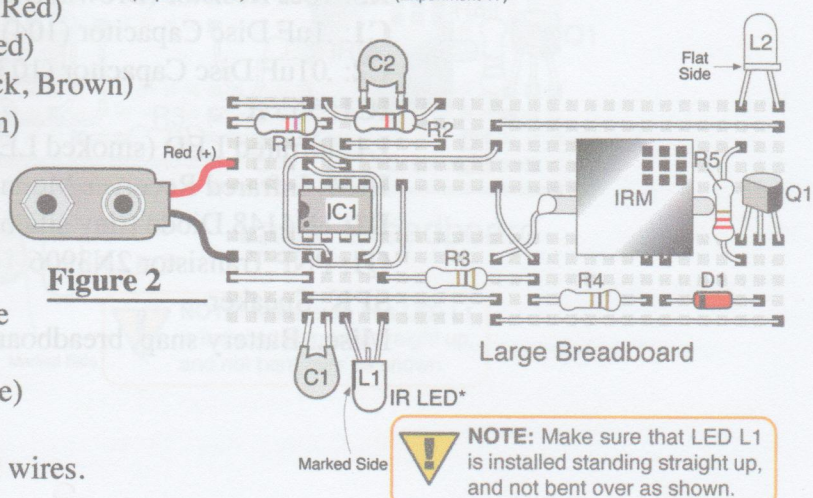

NOTE: Make sure that LED L1 is installed standing straight up, and not bent over as shown.

Experiment 21-

Audible Infrared Proximity Detector

In this experiment you will build an audible infrared proximity detector that emits sound when an object gets close to it. The circuit combines the infrared transmitter of experiment 18, with the audible infrared detector of experiment 19. Both circuits are built on the same board.

The IR LED of the transmitter (L1), emits an IR light beam that bounces from the object and strikes the infrared receiver module (IRM) in the receiver (figure 1). If no object is near, the IR beam emitted by the transmitter will go away and will not be detected by the receiver. This proximity detector will detect objects several inches away from the IR LED.

Procedure:

- Build the circuit shown in figures 1 and 2. If desired, you can modify the circuit built in experiment 20 by replacing the LED L2 with the speaker and making R5 a 10 Ω resistor instead of 220 Ω . Be sure that the IR LED L1 is pointing up. When done, verify that the circuit has been properly assembled per figure 2, and connect a fresh 9V battery to the snap.

- Test the circuit by sliding your hand about 3 inches in front of the IR LED L1. As you do this, the speaker should emit a sound, indicating the detection of the object, in this case your hand.

Determine the maximum distance of detection for several objects.

Parts List:

R1: 4.7K Ω Resistor (Yellow, Violet, Red)

R2: 1K Ω Resistor (Brown, Black, Red)

R3, R4: 100 Ω Resistor (Brown, Black, Brown)

R5: 10 Ω Resistor (Brown, Black, Black)

C1: .1 μ F Disc Capacitor (104)

C2: .01 μ F Disc Capacitor (103)

IC1: 555 IC

L1: Infrared LED (smoked LED)

IRM: Infrared Receiver Module

D1: 1N4148 Diode (tiny silicon diode)

Q1: PNP Transistor 2N3906

SPK: Speaker

Misc.: Battery snap, breadboard, and wires.

Figure 1

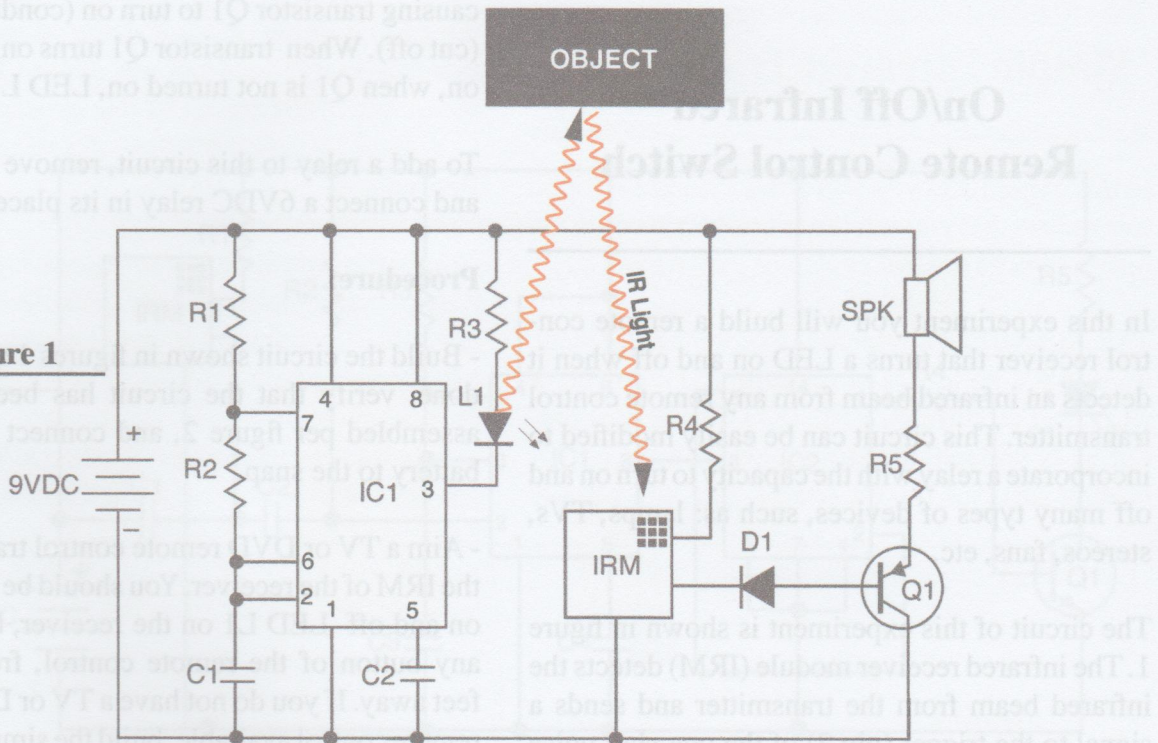

NOTE: If the speaker emits a continuous sound, slightly bend IR LED L1 away from the IRM module to avoid direct IR light reaching the IRM module.

Figure 2

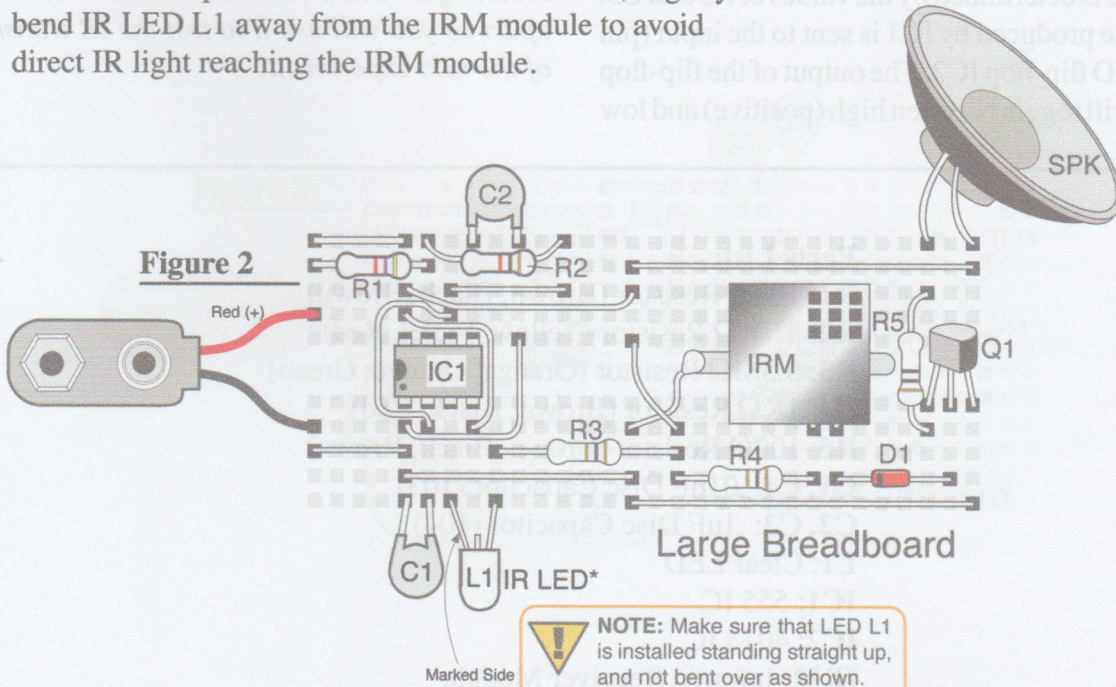

NOTE: Make sure that LED L1 is installed standing straight up, and not bent over as shown.

Experiment 22-

On/Off Infrared Remote Control Switch

In this experiment you will build a remote control receiver that turns a LED on and off when it detects an infrared beam from any remote control transmitter. This circuit can be easily modified to incorporate a relay with the capacity to turn on and off many types of devices, such as: lamps, TVs, stereos, fans, etc.

The circuit of this experiment is shown in figure 1. The infrared receiver module (IRM) detects the infrared beam from the transmitter and sends a signal to the trigger (pin 2) of the one-shot pulse generator made with the 555 IC (IC1). IC1 will produce one pulse on its output (pin 3) every time the IRM detects an infrared beam. The length of this pulse is determined by the values of R3 and C3. The pulse produced by IC1 is sent to the input (pin 3) of the D flip-flop IC2. The output of the flip-flop (pin 1) will toggle between high (positive) and low

(negative) with every pulse arriving at the input, causing transistor Q1 to turn on (conduct) and off (cut off). When transistor Q1 turns on, LED L1 is on, when Q1 is not turned on, LED L1 is off.

To add a relay to this circuit, remove resistor R5 and connect a 6VDC relay in its place.

Procedure:

- Build the circuit shown in figures 1 and 2. When done, verify that the circuit has been properly assembled per figure 2, and connect a fresh 9V battery to the snap.

- Aim a TV or DVD remote control transmitter to the IRM of the receiver. You should be able to turn on and off LED L1 on the receiver, by pressing any button of the remote control, from several feet away. If you do not have a TV or DVD player remote control available, build the simple infrared transmitter of experiment 23. Using this simple transmitter the range will only be a few inches.

Note: After completion do not take this circuit apart as you will use it to test the IR transmitter of the next experiment.

Parts List:

- R1:** 100Ω Resistor (Brown, Black, Brown)
- R2:** 4.7KΩ Resistor (Yellow, Violet, Red)
- R3:** 3.3MΩ Resistor (Orange, Orange, Green)
- R4:** 1KΩ Resistor (Brown, Black, Red)
- R5:** 100Ω Resistor (Brown, Black, Brown)
- C1, C4:** .01uF Disc Capacitor (103)
- C2, C3:** .1uF Disc Capacitor (104)
- L1:** Clear LED
- IC1:** 555 IC
- IC2:** 4013 IC
- IRM:** Infrared Receiver Module
- Q1:** NPN Transistor 2N3904
- Misc.:** Battery snap, breadboard, and wires.

Figure 1

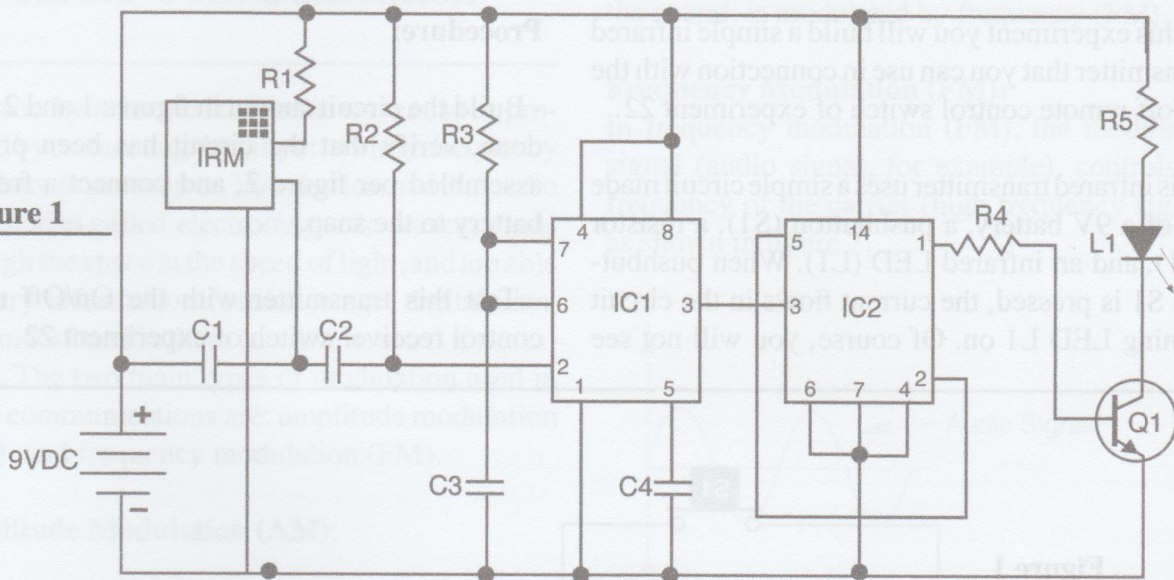
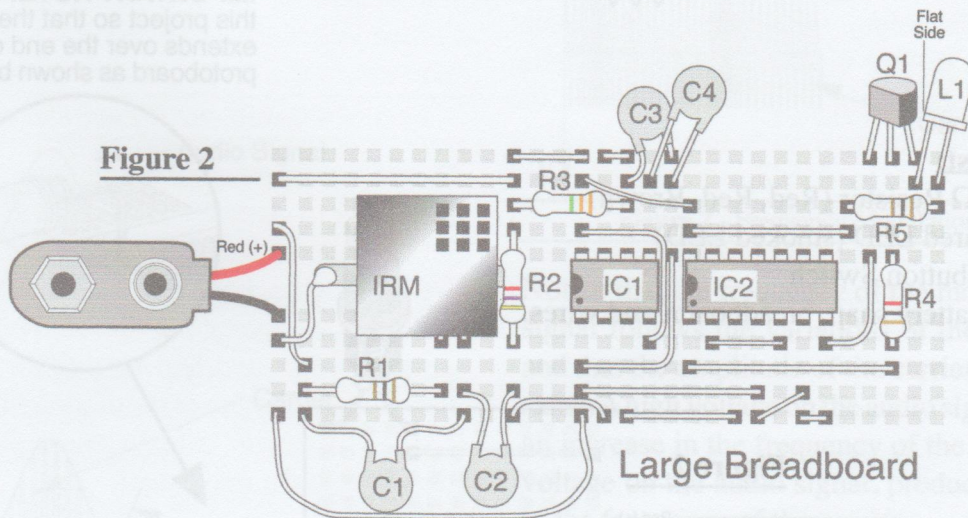

Figure 2



Experiment 23-

Simple Infrared Transmitter

In this experiment you will build a simple infrared transmitter that you can use in connection with the on/off remote control switch of experiment 22.

This infrared transmitter uses a simple circuit made up of a 9V battery, a pushbutton (S1), a resistor (R1), and an infrared LED (L1). When pushbutton S1 is pressed, the current flows in the circuit turning LED L1 on. Of course, you will not see

the LED lighting up, as it emits an infrared light that human eyes can not see. Figure 1 shows the schematic of the circuit of this experiment.

Procedure:

- Build the circuit shown in figures 1 and 2. When done, verify that the circuit has been properly assembled per figure 2, and connect a fresh 9V battery to the snap.
- Test this transmitter with the On/Off remote control receiver switch of experiment 22.

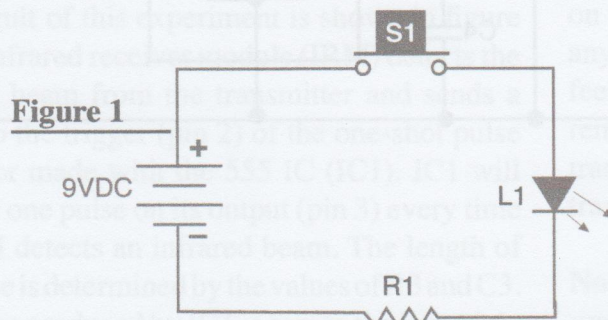

IMPORTANT NOTE: Build this project so that the LED extends over the end of the protoboard as shown below.

Parts List:

- R1:** 220 Ω Resistor (Red, Red, Brown)
- L1:** Infrared LED (smoked LED)
- S1:** Pushbutton Switch
- Misc.:** Battery snap, breadboard, and wires.

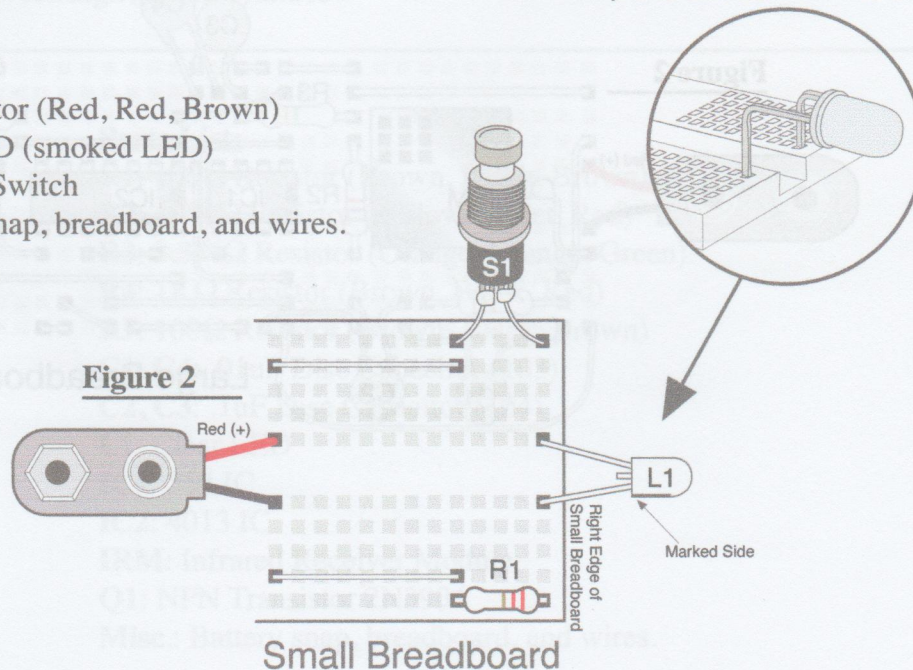

Lesson 7-

AM & FM Radio Communication

In lesson 3 you learned that radio waves can be produced by connecting the output of a high frequency oscillator to an antenna. You also learned that radio waves, also called electromagnetic waves, travel through the space at the speed of light, and are able to carry information (audio, image, digital data, etc.) modulated in them (review lesson 3 if necessary). The two main types of modulation used in radio communications are: amplitude modulation (AM), and frequency modulation (FM).

Amplitude Modulation (AM):

In amplitude modulation, the modulating signal (audio signal, for example) controls the amplitude of the carrier (high frequency signal), as shown in figure 1.

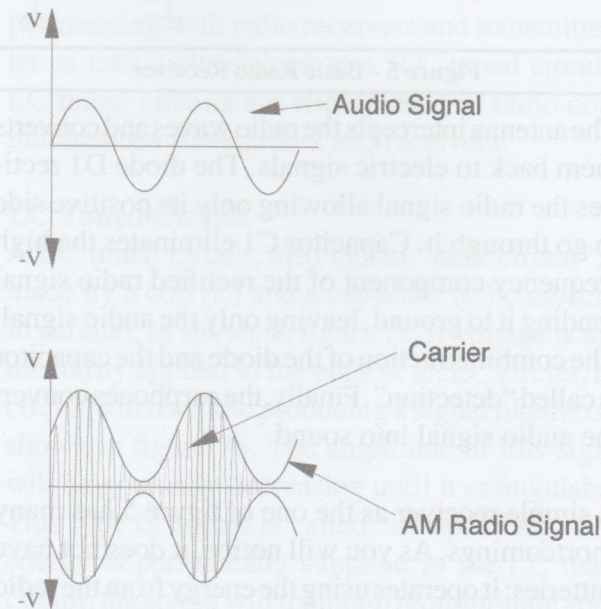

Figure 1 - Amplitude Modulation (AM)

Notice that the peak-to-peak voltage (amplitude) of the modulated radio signal, follows the variations of the audio signal. Amplitude modulation is extensively used in middle-wave and short-wave radio broadcasting, and TV transmissions. The image in TV transmissions is modulated by amplitude, while the sound, is modulated by frequency (FM).

Frequency Modulation (FM):

In frequency modulation (FM), the modulating signal (audio signal, for example), controls the frequency of the carrier (high frequency signal), as shown in figure 2.

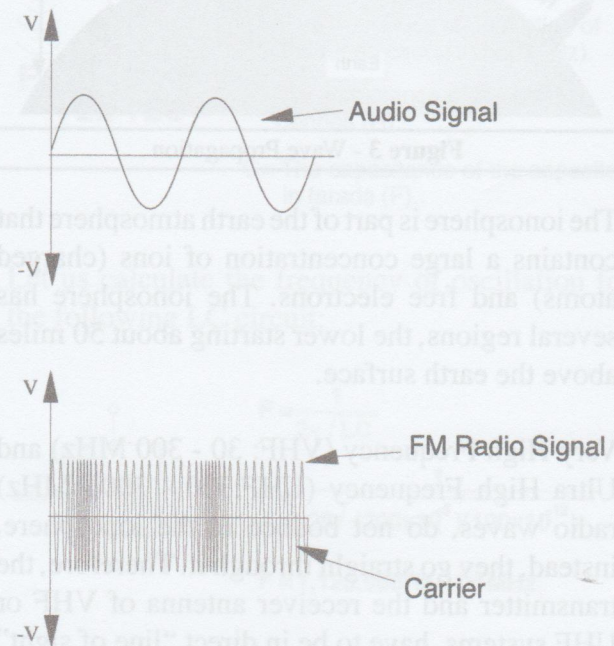

Figure 2 - Frequency Modulation (FM)

Notice that the frequency of the modulated radio signal follows the variations of the audio signal and that the amplitude of the carrier is always the same. A high voltage on the audio signal, produces an increase in the frequency of the carrier; a low voltage on the audio signal, produces a decrease in the frequency of the carrier.

FM transmissions are almost static free as atmospheric interference and electrostatic fields affect the amplitude, but not the frequency of the carrier. Therefore, FM usually produces static free, crystal clear communications.

Radio Waves Propagation

Another interesting aspect of radio communication is the way in which the radio waves propagate or travel through the space. High frequency radio waves (3-30 MHz) travel long distances on the earth, by bouncing between the earth surface and the ionosphere (figure 3). Short-wave world-wide radio communication is based on this principle.

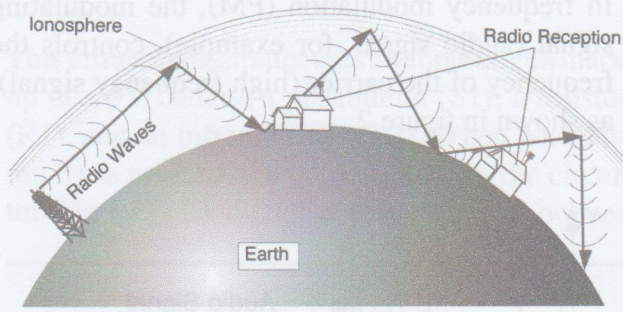

Figure 3 - Wave Propagation

The ionosphere is part of the earth atmosphere that contains a large concentration of ions (charged atoms) and free electrons. The ionosphere has several regions, the lower starting about 50 miles above the earth surface.

Very High Frequency (VHF: 30 - 300 MHz) and Ultra High Frequency (UHF:300 - 3000 MHz) radio waves, do not bounce in the ionosphere, instead, they go straight through it. Therefore, the transmitter and the receiver antenna of VHF or UHF systems, have to be in direct "line of sight" from each other in order for the communication to take place, as shown in figure 4.

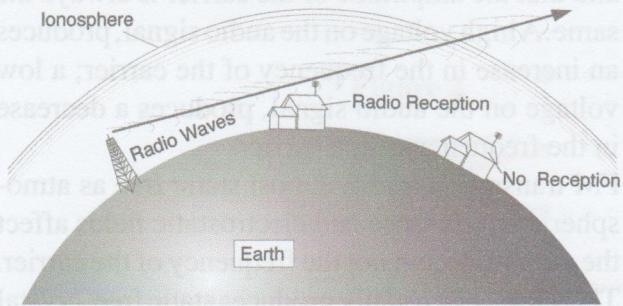

Figure 4 - VHF Transmission

TV stations use some of these frequencies (VHF and UHF). The transmitting antennas of TV stations, are always located in the tallest point or hill in town, to be able to reach most places by direct line-of-sight. Still, good reception, becomes almost impossible in some locations, depending of the geographic characteristics of the terrain. This problem was solved by cable TV companies transporting the TV signals by cable, instead of open space propagation.

Radio waves of higher frequencies: SHF (super high frequencies: 3 -30GHz),EHF (extremely high frequencies: 30 - 300 GHz), and microwaves (300 - 3000 GHz) behave practically as light waves, were a direct line-of-sight is required for the communication to take place.

Basic Radio Receiver

Figure 5 shows a basic AM radio receiver.

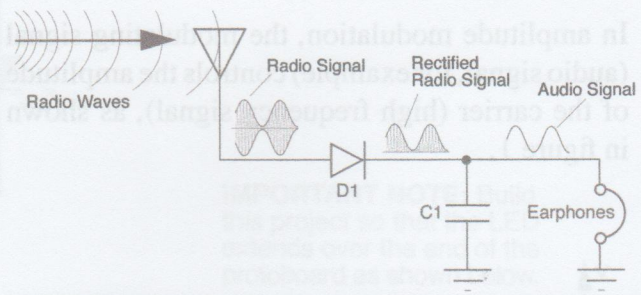

Figure 5 - Basic Radio Receiver

The antenna intercepts the radio waves and converts them back to electric signals. The diode D1 rectifies the radio signal allowing only its positive side to go through it. Capacitor C1 eliminates the high frequency component of the rectified radio signal sending it to ground, leaving only the audio signal. The combined action of the diode and the capacitor is called "detection". Finally, the earphones convert the audio signal into sound.

A simple receiver as the one of figure 5 has many shortcomings. As you will notice, it does not have batteries; it operates using the energy from the radio waves, therefore, only strong radio stations in close proximity to the receiver will be heard. Also, this receiver lacks the ability to select between radio stations, several radio station will be heard at the

same time. Besides, in order to properly operate, this receiver requires a long antenna and a connection to ground, to allow a path for the current to flow.

Figure 6 shows an improved version of the basic radio receiver. Notice that it has a tuned circuit made of coils L1 and L2 and variable capacitor C1, to allow the tuning of one specific radio station at a time. It also has the detector circuit (D1 and C2) and an audio amplifier that will make it possible to hear weaker stations on the speaker. This receiver, even though not practical yet, will provide a better reception than the one of figure 5.

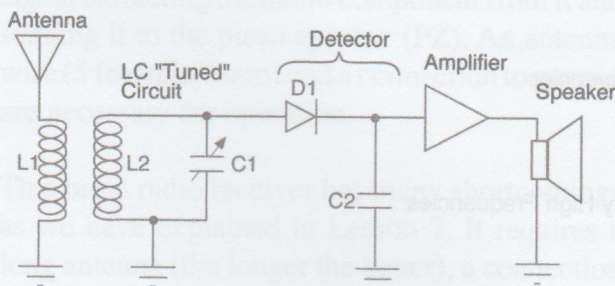

Figure 6 - Radio Receiver with Tuner and Amp

In this lab you will build several AM radio receivers, starting with a basic receiver and moving forward making improvements to it. Before you start experimenting with radio receivers and transmitters, let us take a closer look at a "LC tuned circuit". LC tuned circuits are widely used in radio communications transmitters and receivers.

LC Tuned Circuit

A LC tuned circuit, also called "tank circuit", is made by a coil (L) and a capacitor (C) connected in parallel, as shown in figure 7a. If voltage is momentarily applied to the ends of an LC circuit, the circuit will oscillate producing a signal like the one shown in figure 7b. The amplitude of this signal will be gradually decreasing until it extinguishes. This type of signal is called "damped" signal. If energy is periodically supplied to the LC tuned circuit, the signal will maintain its amplitude and it will not extinguish. This type of circuits are called "LC oscillators".

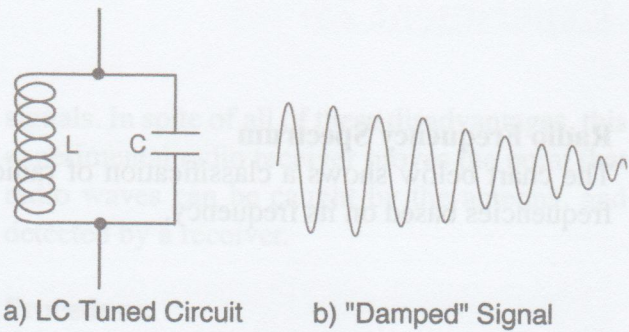

Figure 7 - LC Tuned Circuit

The frequency of oscillation of an LC tuned circuit is calculated using the following formula:

$$F = \frac{1}{2\pi \sqrt{LC}}$$

F= The frequency of oscillation of the tuned circuit in hertz (Hz).

L= The inductance of the coil in henries (H).

C= The capacitance of the capacitor in farads (F).

Let us calculate the frequency of oscillation for the following LC circuit:

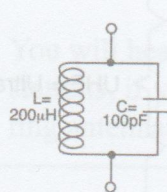

$$F = \frac{1}{2\pi \sqrt{LC}}$$

$$F = \frac{1}{6.28 \sqrt{(200 \times 10^{-6})(100 \times 10^{-12})}}$$

$$F = 1,125,966 \text{ Hz} \approx 1.1 \text{ MHz}$$

LC tuned circuits are used in radio transmitters as oscillators, generating the radio signals sent to the transmitting antennas. LC tuned circuit are also used in radio receivers, selecting one radio station among all the others. LC tuned circuits used in radio receivers will allow only the signals with frequencies close to the frequency of oscillation of the LC tuned circuit to be received. All the other signals with frequencies different to the one of the LC tuned circuit will be rejected.

Radio Frequency Spectrum

The chart below shows a classification of radio frequencies based on its frequency.

Now that you have a basic understanding of radio communications, you can move forward to the next experiments, where you will build several experimental AM radio receivers, and AM and FM radio transmitters.

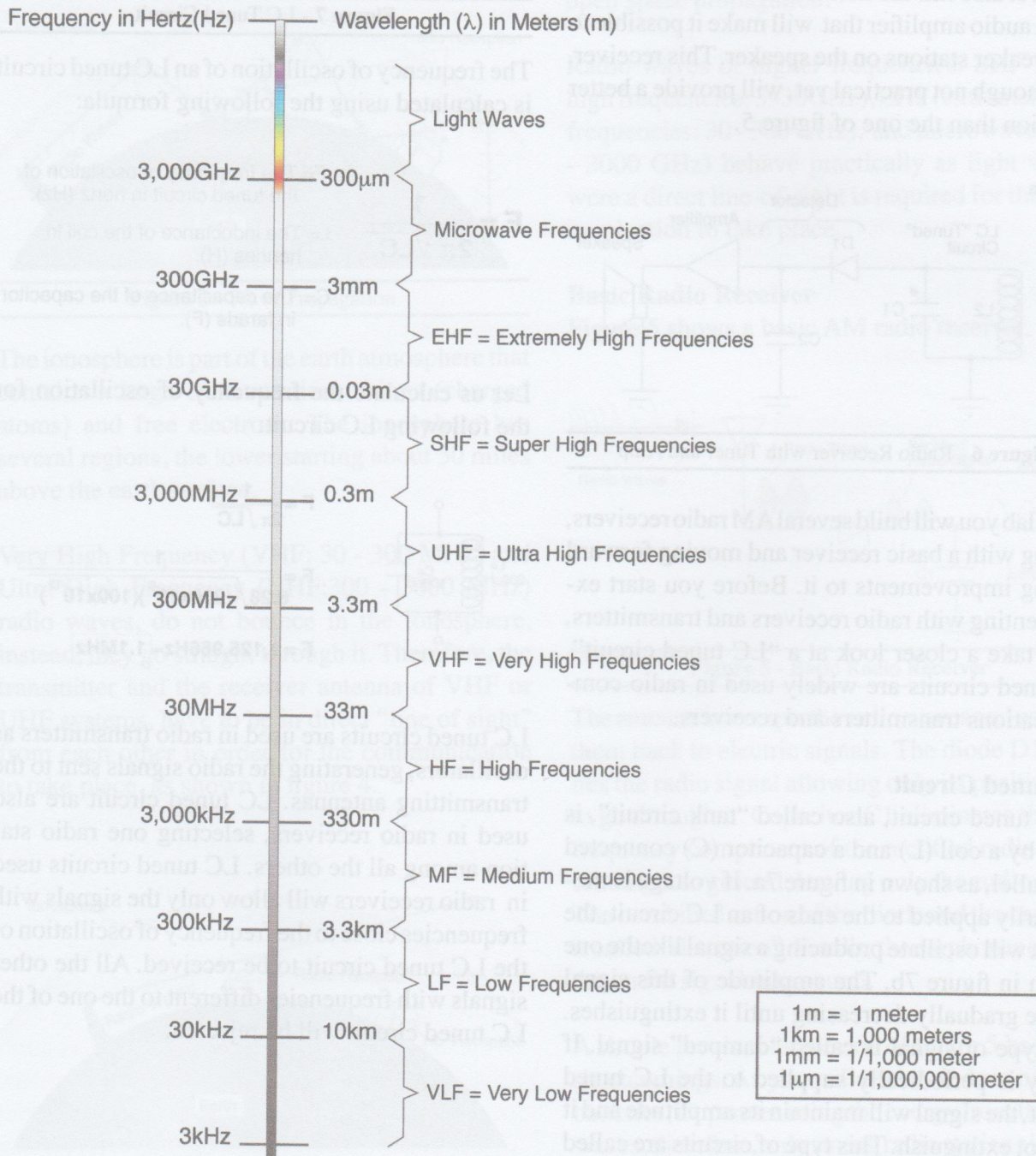

Experiment 24-

Crystal Radio Receiver

In this experiment you will build a simple AM radio receiver that operates using only the energy of the radio waves. The schematic diagram of this receiver is shown in figure 1. The antenna intercepts the radio waves and changes them back into electrical signals. The LC tuned circuit made of coils L1, L2 and variable capacitor C1, provides selectivity to the receiver to tune different radio stations. Diode D1 and capacitor C2 detect the radio signal extracting the audio component from it and sending it to the piezo speaker (PZ). An antenna wire (5 feet minimum) and a connection to ground are necessary for operation.

This basic radio receiver has many shortcomings as we have explained in Lesson 7. It requires a long antenna (the longer the better), a connection to ground, it will only receive a few local radio stations, and it does not have a good selectivity, as you will hear the stations overlapping. Also, you will have to put your ear very close to the piezo speaker to be able to hear the stations, as there is no amplification for the radio or audio

signals. In spite of all of these disadvantages, this experimental radio receiver proves the point that radio waves can be caught by the antenna, and detected by a receiver.

Procedure:

- Build the circuit shown in figures 1 and 2. Notice that the components inside the trace line on figure 1 are part of the tuner board. When done, verify that the circuit has been properly assembled.
- Connect a 5 foot antenna wire (supplied) and let it go from the breadboard to the floor.
- Connect ground to the breadboard. Use a connection to a metal water pipe or other metal grounded conduit.
- Put your ear on top of the piezo speaker and tune capacitor C1 on the receiver board.

You will hear a couple of faint overlapping radio stations, if you are in the proximity of transmitting antennas.

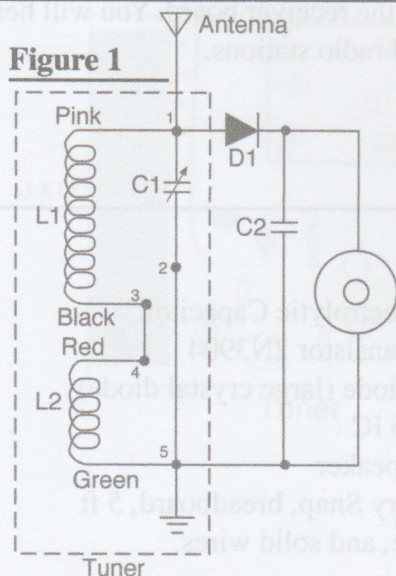

Parts List:

- Tuner Board (L1, L2, C1)
- D1: 1N60 Diode (large crystal diode)
- C2: .001uF Disc Capacitor (102)
- PZ: Piezo Speaker
- Misc.: Breadboard, 5 feet antenna wire, and solid wires.

Note: If you are far away from an AM broadcast antenna or inside a building with poor reception, this experiment will not work.

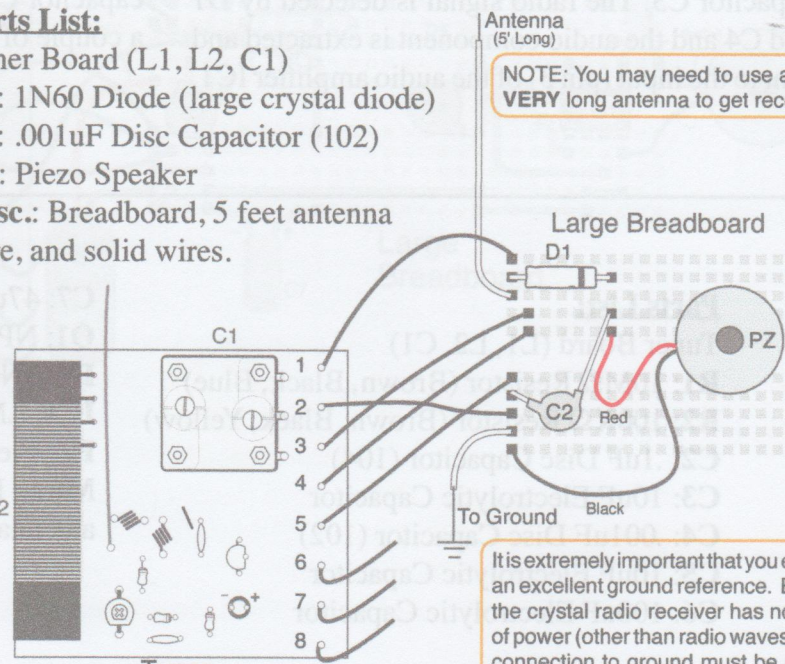

NOTE: You may need to use a **VERY** long antenna to get reception.

It is extremely important that you establish an excellent ground reference. Because the crystal radio receiver has no source of power (other than radio waves) a good connection to ground must be made to complete the circuit.

Experiment 25-

Basic AM Radio Receiver

In this experiment you will improve the basic radio receiver that you built in experiment 24. This circuit includes a transistor (Q1) that amplifies the tuned radio signal before it is sent to the detector. It also includes an IC audio amplifier (IC1), that amplifies the audio signal before it is sent to the piezo speaker. This circuit does not require a connection to ground. With this experimental AM radio receiver you will be able to hear a couple of local radio stations a little louder than in the circuit of experiment 24. Figure 1 shows the schematic diagram of this experiment. The antenna intercepts the radio waves and transforms them into radio signals. The tuned LC circuit made by C1 and L1, tune to one specific radio station according to value of the variable capacitor C1.

The signal of the tuned radio station is induced on coil L2 and sent to the base of transistor Q1 through capacitor C2. Transistor Q1 amplifies the radio signal and sends it to the detector through capacitor C3. The radio signal is detected by D1 and C4 and the audio component is extracted and sent to the input (pin 3) of the audio amplifier IC1.

IC1 amplifies the audio signal and sends it to the piezo speaker PZ through capacitor C6.

Resistors R1 and R2 are part of the bias circuit of Q1. Capacitor C5 determines the gain of IC1, and capacitor C7 acts as a filter to add stability to the circuit.

Procedure:

- Build the circuit shown in figures 1 and 2. Notice that the components inside the trace line on figure 1 are part of the tuner board. When done, verify that the circuit has been properly assembled.
- Connect a 5 ft long antenna wire (supplied) and let it go from the breadboard to the floor.
- Connect a fresh 9V battery to the battery snap.
- Put your ear on top of the piezo speaker and tune capacitor C1 on the receiver board. You will hear a couple of local radio stations.

Parts List:

Tuner Board (L1, L2, C1)

R1: 10M Ω Resistor (Brown, Black, Blue)

R2: 100K Ω Resistor (Brown, Black, Yellow)

C2: .1 μ F Disc Capacitor (104)

C3: 10 μ F Electrolytic Capacitor

C4: .001 μ F Disc Capacitor (102)

C5: 10 μ F Electrolytic Capacitor

C6: 100 μ F Electrolytic Capacitor

C7: 47 μ F Electrolytic Capacitor.

Q1: NPN Transistor 2N3904

D1: 1N60 Diode (large crystal diode)

IC1: LM386 IC

PZ: Piezo Speaker

Misc.: Battery Snap, breadboard, 5 ft antenna wire, and solid wires.

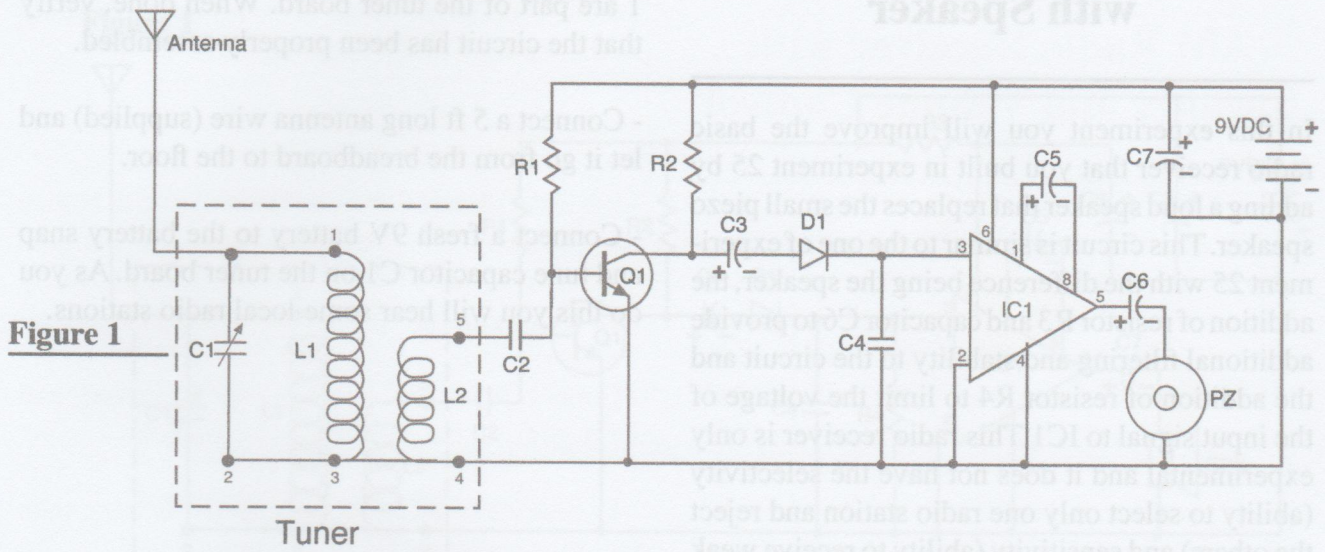
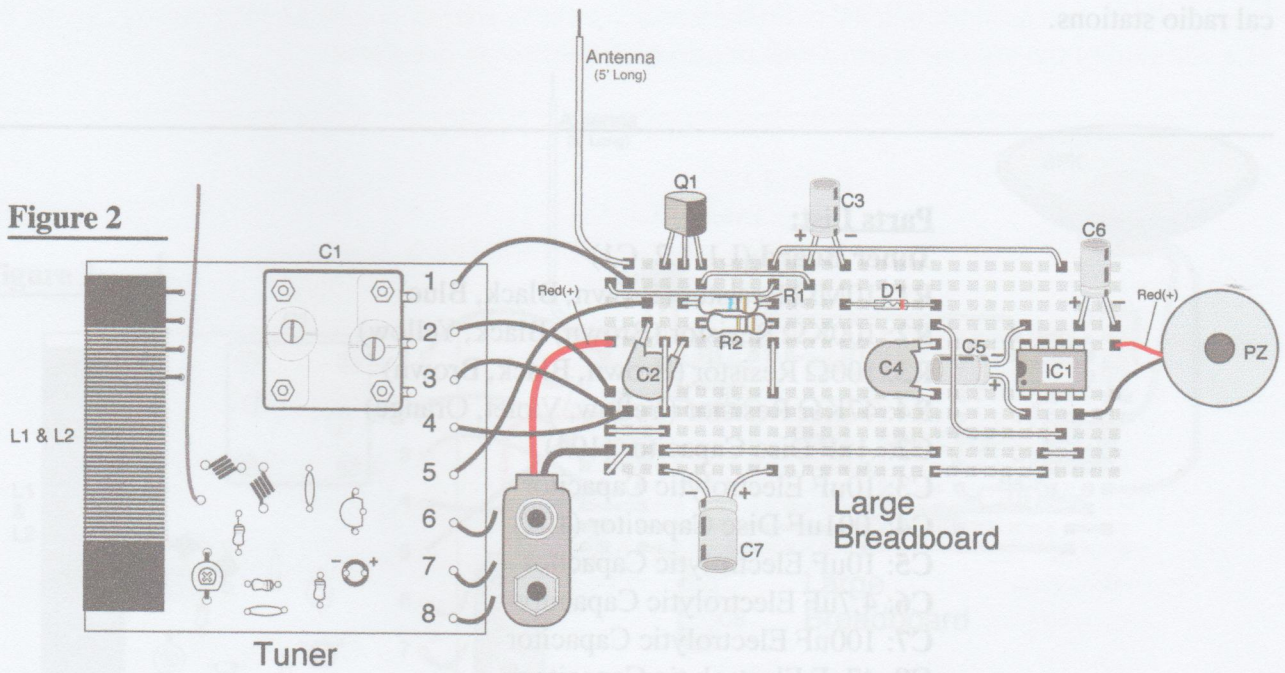

Figure 2



Experiment 26-

AM Radio Receiver with Speaker

In this experiment you will improve the basic radio receiver that you built in experiment 25 by adding a loud speaker that replaces the small piezo speaker. This circuit is similar to the one of experiment 25 with the difference being the speaker, the addition of resistor R3 and capacitor C6 to provide additional filtering and stability to the circuit and the addition of resistor R4 to limit the voltage of the input signal to IC1. This radio receiver is only experimental and it does not have the selectivity (ability to select only one radio station and reject the others) and sensitivity (ability to receive weak radio stations) of commercial receivers. But you will be able to hear loud and clear a couple of local radio stations.

Procedure:

- Build the circuit shown in figures 1 and 2. Notice that the components inside the trace line on figure 1 are part of the tuner board. When done, verify that the circuit has been properly assembled.

- Connect a 5 ft long antenna wire (supplied) and let it go from the breadboard to the floor.

- Connect a fresh 9V battery to the battery snap and tune capacitor C1 on the tuner board. As you do this you will hear some local radio stations.

Parts List:

Tuner Board (L1, L2, C1)

R1: 10M Ω Resistor (Brown, Black, Blue)

R2: 100K Ω Resistor (Brown, Black, Yellow)

R3: 100 Ω Resistor (Brown, Black, Brown)

R4: 47K Ω Resistor (Yellow, Violet, Orange)

C2: .1 μ F Disc Capacitor (104)

C3: 10 μ F Electrolytic Capacitor

C4: .001 μ F Disc Capacitor (102)

C5: 10 μ F Electrolytic Capacitor

C6: 4.7 μ F Electrolytic Capacitor

C7: 100 μ F Electrolytic Capacitor

C8: 47 μ F Electrolytic Capacitor

Q1: NPN Transistor 2N3904

D1: 1N60 Diode (large crystal diode)

IC1: LM386 IC

SPK: Speaker

Misc.: Battery Snap, breadboard, 5 ft antenna wire, and solid wires.

Figure 1

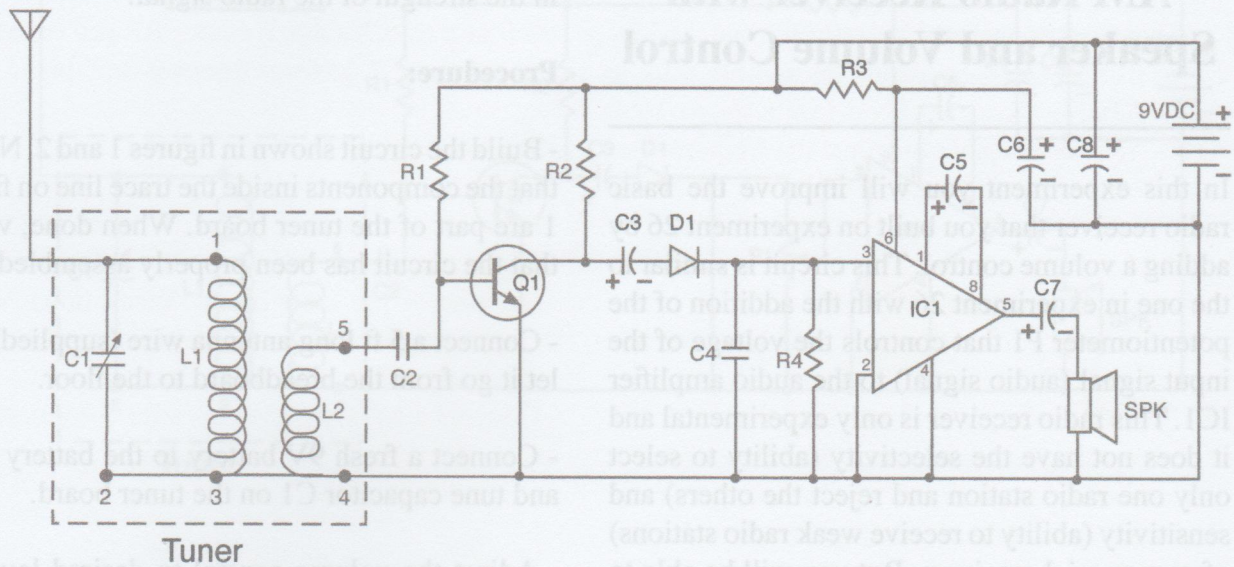
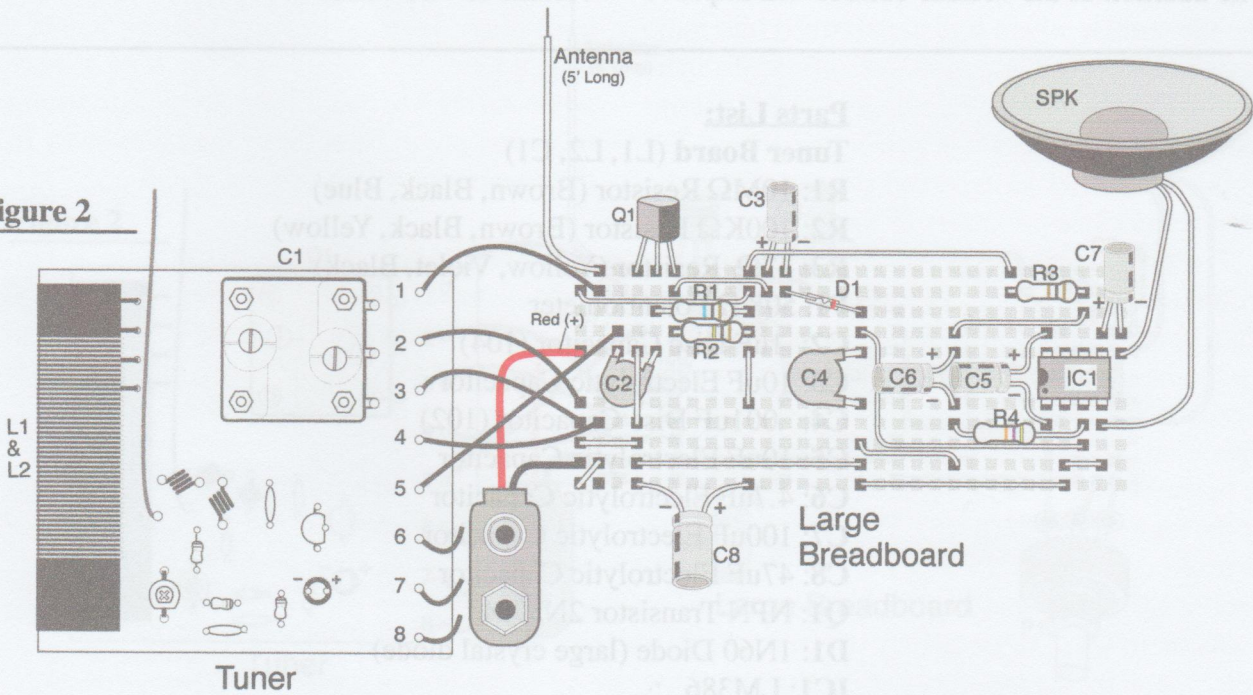

Figure 2



Experiment 27-

AM Radio Receiver with Speaker and Volume Control

In this experiment you will improve the basic radio receiver that you built on experiment 26 by adding a volume control. This circuit is similar to the one in experiment 26 with the addition of the potentiometer P1 that controls the voltage of the input signal (audio signal) to the audio amplifier IC1. This radio receiver is only experimental and it does not have the selectivity (ability to select only one radio station and reject the others) and sensitivity (ability to receive weak radio stations) of commercial receivers. But you will be able to hear loud and clear a couple of local radio stations. The addition of the volume control will improve

Procedure:

the quality of sound produced by this receiver, as you will be able to compensate for the differences in the strength of the radio signal.

Procedure:

- Build the circuit shown in figures 1 and 2. Notice that the components inside the trace line on figure 1 are part of the tuner board. When done, verify that the circuit has been properly assembled.
- Connect a 5 ft long antenna wire (supplied) and let it go from the breadboard to the floor.
- Connect a fresh 9V battery to the battery snap and tune capacitor C1 on the tuner board.
- Adjust the volume control to desired level. If a radio station comes in very strong, lower the volume or vice versa.

Parts List:

Tuner Board (L1, L2, C1)

R1: 10M Ω Resistor (Brown, Black, Blue)

R2: 100K Ω Resistor (Brown, Black, Yellow)

R3: 47 Ω Resistor (Yellow, Violet, Black)

P1: 50K Ω Potentiometer

C2: .1 μ F Disc Capacitor (104)

C3: 10 μ F Electrolytic Capacitor

C4: .001 μ F Disc Capacitor (102)

C5: 10 μ F Electrolytic Capacitor

C6: 4.7 μ F Electrolytic Capacitor

C7: 100 μ F Electrolytic Capacitor

C8: 47 μ F Electrolytic Capacitor

Q1: NPN Transistor 2N3904

D1: 1N60 Diode (large crystal diode)

IC1: LM386

SPK: Speaker

Misc.: Battery Snap, breadboard, 5 ft antenna wire, and solid wires.

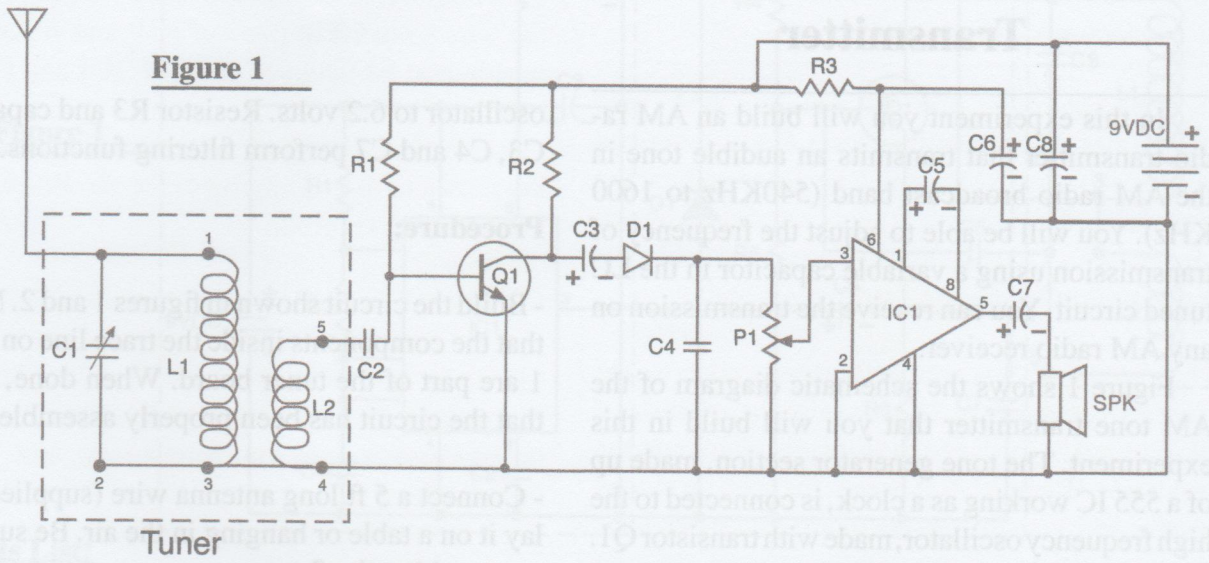
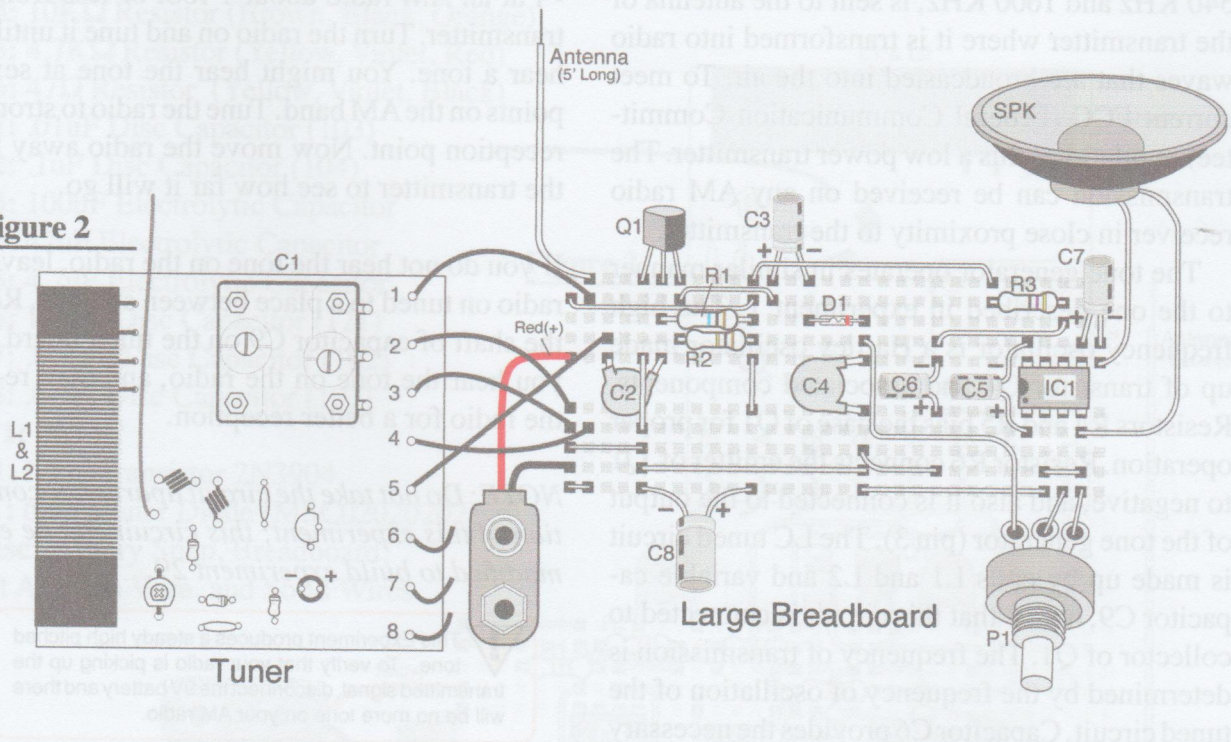

Figure 2



Experiment 28-

AM Tone Transmitter

In this experiment you will build an AM radio transmitter that transmits an audible tone in the AM radio broadcast band (540KHz to 1600 KHz). You will be able to adjust the frequency of transmission using a variable capacitor in the LC tuned circuit. You can receive the transmission on any AM radio receiver.

Figure 1 shows the schematic diagram of the AM tone transmitter that you will build in this experiment. The tone generator section, made up of a 555 IC working as a clock, is connected to the high frequency oscillator, made with transistor Q1. The audio signal produced by the tone generator modulates (by amplitude) the high frequency signal produced by the high frequency oscillator. This modulated radio signal, with a frequency between 540 KHz and 1600 KHz, is sent to the antenna of the transmitter where it is transformed into radio waves that are broadcasted into the air. To meet current FCC (Federal Communication Committee) regulations this a low power transmitter. The transmission can be received on any AM radio receiver in close proximity to the transmitter.

The tone generator operates in similar manner to the one described in experiment 1. The high frequency oscillator is a Hartley oscillator made up of transistor Q1 and associated components. Resistors R4 and R5 bias the base of Q1 for proper operation. Resistor R6 connects the emitter of Q1 to negative, and also it is connected to the output of the tone generator (pin 3). The LC tuned circuit is made up by coils L1 and L2 and variable capacitor C9, notice that this circuit is connected to collector of Q1. The frequency of transmission is determined by the frequency of oscillation of the tuned circuit. Capacitor C6 provides the necessary positive feedback between the output of the oscillator (LC tuned circuit on collector) and its input (base of Q1) for the oscillations to take place. Zener diode D1 sets the voltage that powers the

oscillator to 6.2 volts. Resistor R3 and capacitors C3, C4 and C7 perform filtering functions.

Procedure:

- Build the circuit shown in figures 1 and 2. Notice that the components inside the trace line on figure 1 are part of the tuner board. When done, verify that the circuit has been properly assembled.
- Connect a 5 ft long antenna wire (supplied) and lay it on a table or hanging in the air. Be sure it is not touching the floor.
- Connect a fresh 9V battery to the battery snap.
- Put an AM radio about 1 foot or less from the transmitter. Turn the radio on and tune it until you hear a tone. You might hear the tone at several points on the AM band. Tune the radio to strongest reception point. Now move the radio away from the transmitter to see how far it will go.

If you do not hear the tone on the radio, leave the radio on tuned to a place between stations. Rotate the shaft of capacitor C9 on the tuner board until you hear the tone on the radio, and then re-tune the radio for a better reception.

NOTE: Do not take the circuit apart after completion of this experiment; this circuit can be easily modified to build experiment 29.



This Experiment produces a steady high pitched tone. To verify that your radio is picking up the transmitted signal, disconnect the 9V battery and there will be no more tone on your AM radio.

Figure 1

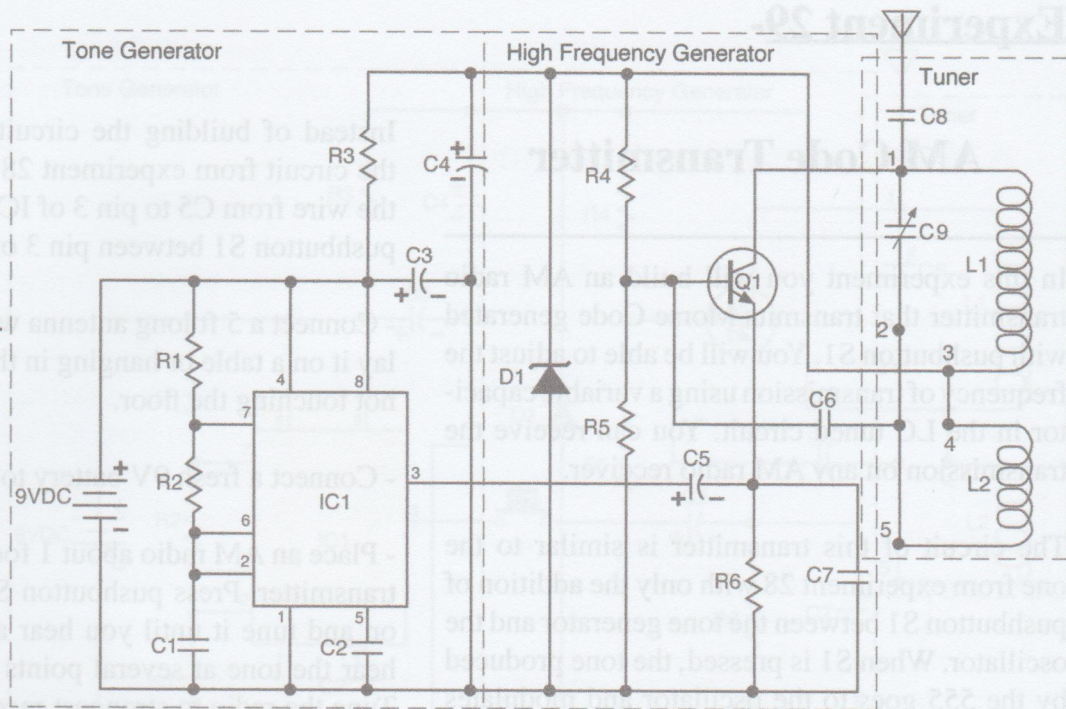

Parts List:

Tuner Board (L1, L2, C9)

R1: 100KΩ Resistor (Brown, Black, Yellow)

R2: 1KΩ Resistor (Brown, Black, Red)

R3: 100Ω Resistor (Brown, Black, Brown)

R4: 10KΩ Resistor (Brown, Black, Orange)

R5: 4.7KΩ Resistor (Yellow, Violet, Red)

R6: 47Ω Resistor (Yellow, Violet, Black)

C1: .01uF Disc Capacitor (103)

C2: .1uF Disc Capacitor (104)

C3: 100uF Electrolytic Capacitor

C4: 47uF Electrolytic Capacitor

C5: 4.7uF Electrolytic Capacitor

C6: 120pF Disc Capacitor (121)

C7: .001uF Disc Capacitor (102)

C8: .01uF Disc Capacitor (103)

IC1: 555 IC

Q1: NPN Transistor 2N3904

D1: 6.2V Zener Diode (MSC02020202)

Misc: Battery Snap, Breadboard, 5 ft Antenna Wire, and Solid Wires.

Figure 2

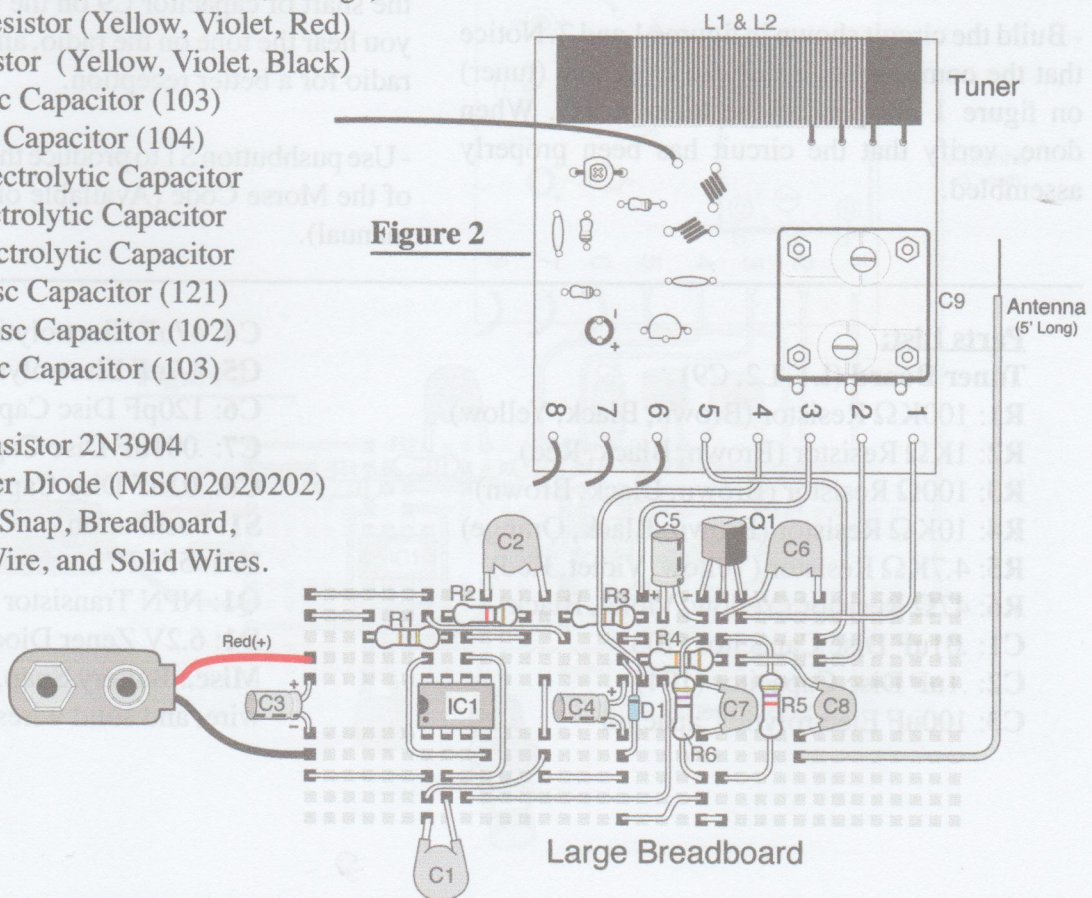

Experiment 29-

AM Code Transmitter

In this experiment you will build an AM radio transmitter that transmits Morse Code generated with pushbutton S1. You will be able to adjust the frequency of transmission using a variable capacitor in the LC tuned circuit. You can receive the transmission on any AM radio receiver.

The circuit of this transmitter is similar to the one from experiment 28 with only the addition of pushbutton S1 between the tone generator and the oscillator. When S1 is pressed, the tone produced by the 555 goes to the oscillator and modulates its signal. When S1 is not pressed (open), the tone does not reach the oscillator and the transmitter emits a radio signal without modulation.

Procedure:

- Build the circuit shown in figures 1 and 2. Notice that the components inside the trace line (tuner) on figure 1 are part of the tuner board. When done, verify that the circuit has been properly assembled.

Instead of building the circuit you can modify the circuit from experiment 28 by disconnecting the wire from C5 to pin 3 of IC1, and connecting pushbutton S1 between pin 3 of IC1 and C5.

- Connect a 5 ft long antenna wire (supplied) and lay it on a table or hanging in the air. Be sure it is not touching the floor.

- Connect a fresh 9V battery to the battery snap.

- Place an AM radio about 1 foot or less from the transmitter. Press pushbutton S1. Turn the radio on and tune it until you hear a tone. You might hear the tone at several points on the AM band. Tune the radio to strongest reception point. Now move the radio away from the transmitter to see how far it will go.

- If you do not hear the tone on the radio, leave the radio on tuned to a place between stations. Rotate the shaft of capacitor C9 on the tuner board until you hear the tone on the radio, and then retune the radio for a better reception.

- Use pushbutton S1 to produce the dots and dashes of the Morse Code (Available on Page 17 of this manual).

Parts List:

Tuner Board (L1, L2, C9)

R1: 100K Ω Resistor (Brown, Black, Yellow)

R2: 1K Ω Resistor (Brown, Black, Red)

R3: 100 Ω Resistor (Brown, Black, Brown)

R4: 10K Ω Resistor (Brown, Black, Orange)

R5: 4.7K Ω Resistor (Yellow, Violet, Red)

R6: 47 Ω Resistor (Yellow, Violet, Black)

C1: .01 μ F Disc Capacitor (103)

C2: .1 μ F Disc Capacitor (104)

C3: 100 μ F Electrolytic Capacitor

C4: 47 μ F Electrolytic Capacitor

C5: 4.7 μ F Electrolytic Capacitor

C6: 120pF Disc Capacitor (121)

C7: .001 μ F Disc Capacitor (102)

C8: .01 μ F Disc Capacitor (103)

S1: Pushbutton

IC1: 555 IC

Q1: NPN Transistor 2N3904

D1: 6.2V Zener Diode (MSC02020202)

Misc.: Battery Snap, breadboard, 5 ft antenna wire, and solid wires.

Experiment 30-

AM Broadcasting Station

In this experiment you will build a low power AM broadcasting station that transmits music from your MP3, CD, or tape player to any AM radio. You will be able to adjust the frequency of transmission using a variable capacitor (C8) in the LC tuned circuit.

Figure 1 shows the circuit of this experiment. The circuit of the transmitter is similar to the high frequency oscillator section of experiments 28 and 29. The input of the transmitter is connected through capacitor C4 to the emitter of transistor Q1. In this manner, the music signal coming from the earphone output of the tape recorder or CD player is used to modulate the radio signal produced by the oscillator. Capacitors C1, C2, and C3 are used as filter capacitors to add stability to the circuit. Resistor R1 and zener diode D1 form a voltage regulator that supplies a stable 6.2 volts to power the transmitter.

Procedure:

- Build the circuit shown in figures 1 and 2. Notice that the components inside the trace line on figure 1 are part of the tuner board. When done, verify that the circuit has been properly assembled.

- Be sure that the 5 ft long antenna wire is laying on a table or hanging in the air. It should not be touching the floor.

- Connect a fresh 9V battery to the battery snap.

- Take a tape player, CD player, or MP3 player. Set the volume control in the middle of its range. Insert the plug coming from the transmitter into the earphone output of the tape recorder. As you do this, the sound from the speaker will stop, as the sound signal is redirected to the transmitter instead of the speaker of the tape recorder.

- Place an AM radio about 1 foot or less from the transmitter and turn the radio on. Tune the radio until you hear the music you are playing from your tape recorder. You might hear the music at several points on the band. Tune to the most powerful reception point and adjust the volume control of the tape recorder to reduce distortion. A low setting on the volume control will produce a clear transmission. A high setting of the volume control of your player will increase the distortion. Move the radio away from the transmitter to see how far it will go.

If you do not hear the music on the radio, leave the radio on, tuned to a place between stations. Rotate the shaft of capacitor C8 on the tuner board, until you hear the music on the radio, then re-tune the radio for a better reception.

Parts List:

Tuner Board (L1, L2, C8)

R1: 100 Ω Resistor (Brown, Black, Brown)

R2: 10K Ω Resistor (Brown, Black, Orange)

R3: 4.7K Ω Resistor (Yellow, Violet, Red)

R4: 47 Ω Resistor (Yellow, Violet, Black)

C1: 10 μ F Electrolytic Capacitor

C2: 47 μ F Electrolytic Capacitor

C3: .1 μ F Disc Capacitor (104)

C4: 4.7 μ F Electrolytic Capacitor

C5: 120pF Disc Capacitor (121)

C6: .001 μ F Disc Capacitor (102)

C7: .01 μ F Disc Capacitor (103)

Q1: NPN Transistor 2N3904

D1: 6.2V Zener Diode (MSC02020202)

Misc.: Battery Snap, breadboard, 5 ft antenna wire, and solid wires.

Experiment 31-

AM Microphone Transmitter

In this experiment you will build an AM microphone transmitter that will broadcast your voice to any AM radio receiver. You will be able to adjust the frequency of transmission using a variable capacitor (C8) in the LC tuned circuit.

Figure 1 shows the circuit of this experiment. The high frequency oscillator section is similar to the one used in previous experiments. The microphone amplifier section amplifies the audio signal coming from the microphone and sends it to the emitter of transistor Q2 where it modulates the radio signal produced by the oscillator. Resistor R1 supplies the microphone with positive voltage to properly operate. Capacitor C2 couples the signal coming from the microphone to the base of Q1. Resistors R2 and R3 provide bias voltage to the base and collector of transistor Q1. Capacitor C4 sends the amplified microphone signal to the emitter of Q2. Capacitors C1 and C3 are used as filter capacitors to add stability to the circuit. Resistor R4 and zener diode D1 form a voltage regulator that supplies a stable 6.2 volts to power the transmitter.

Procedure:

- Build the circuit shown in figures 1 and 2. Notice that the components inside the dotted line (tuner) on figure 1 are part of the tuner board. When done, verify that the circuit has been properly assembled.

- Be sure that the 5 ft long antenna wire is laying on a table or hanging in the air, and that the negative of transmitter is connected to ground.

- Connect a fresh 9V battery to the battery snap.

- Place an AM radio about 1 foot or less from the transmitter and turn the radio on. Put your mouth about 1 inch from the microphone and start blowing into it. Tune the radio until you hear the blowing sound. You might hear the sound at several points in the band, tune to the most powerful reception point. Now start speaking into the microphone and your voice should be heard on the radio. *Please notice that if the radio is too close to the microphone it will produce feedback. If it does, move the radio farther away from the microphone.*

If you do not hear the sound on the radio, leave the radio on, tuned to a place between stations. Rotate the shaft of capacitor C8 on the tuner board while blowing into the microphone, until you hear the sound on the radio, then re-tune the radio for a better reception.

Parts List:

Tuner Board (L1, L2, C8)

R1: 24K Ω Resistor (Red, Yellow, Orange)

R2: 100K Ω Resistor (Brown, Black, Yellow)

R3: 10K Ω Resistor (Brown, Black, Orange)

R4: 100 Ω Resistor (Brown, Black, Brown)

R5: 10K Ω Resistor (Brown, Black, Orange)

R6: 4.7K Ω Resistor (Yellow, Violet, Red)

R7: 47 Ω Resistor (Yellow, Violet, Black)

C1: 10uF Electrolytic Capacitor

C2: 10uF Electrolytic Capacitor

C3: 47uF Electrolytic Capacitor

C4: .1uF Disc Capacitor (104)

C5: 120pF Disc Capacitor (121)

C6: .001uF Disc Capacitor (102)

C7: .01uF Disc Capacitor (103)

Q1: NPN Transistor 2N3904

Q2: NPN Transistor 2N3904

D1: 6.2V Zener Diode (MSC02020202)

M1: Electret Microphone

Misc.: Battery Snap, breadboard, 5 ft antenna wire, and solid wires.

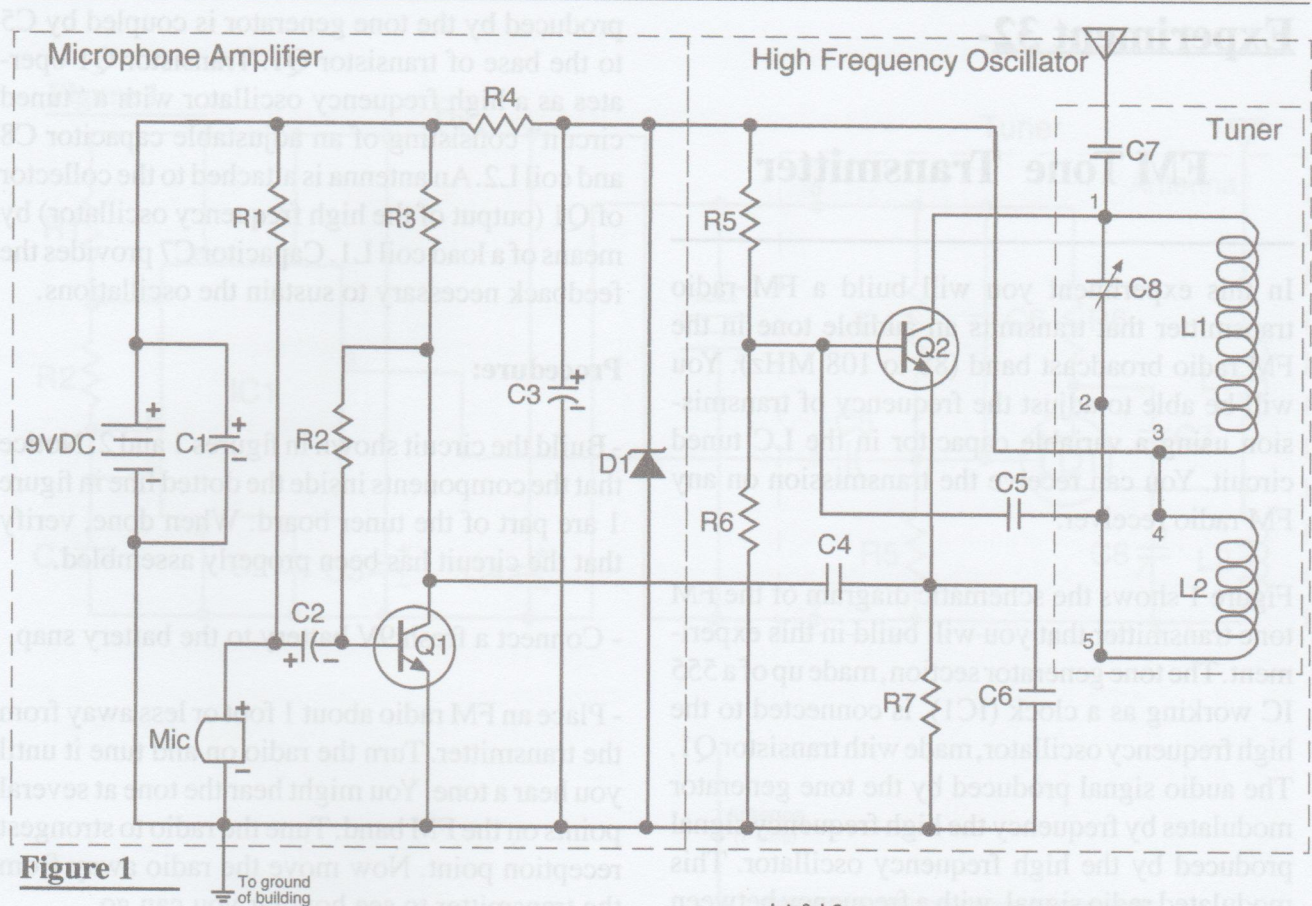

Figure 1

! You will have to experiment to find the best position for both the transmitter and your AM radio. The transmitter is **VERY** weak. Have patients as you tune your AM radio and transmitter. The transmitted signal will be faint and may have some static/interference. We have found that non-digital AM radios work best. You will notice that your voice is not very clear when picked up on your radio. This is to be expected.

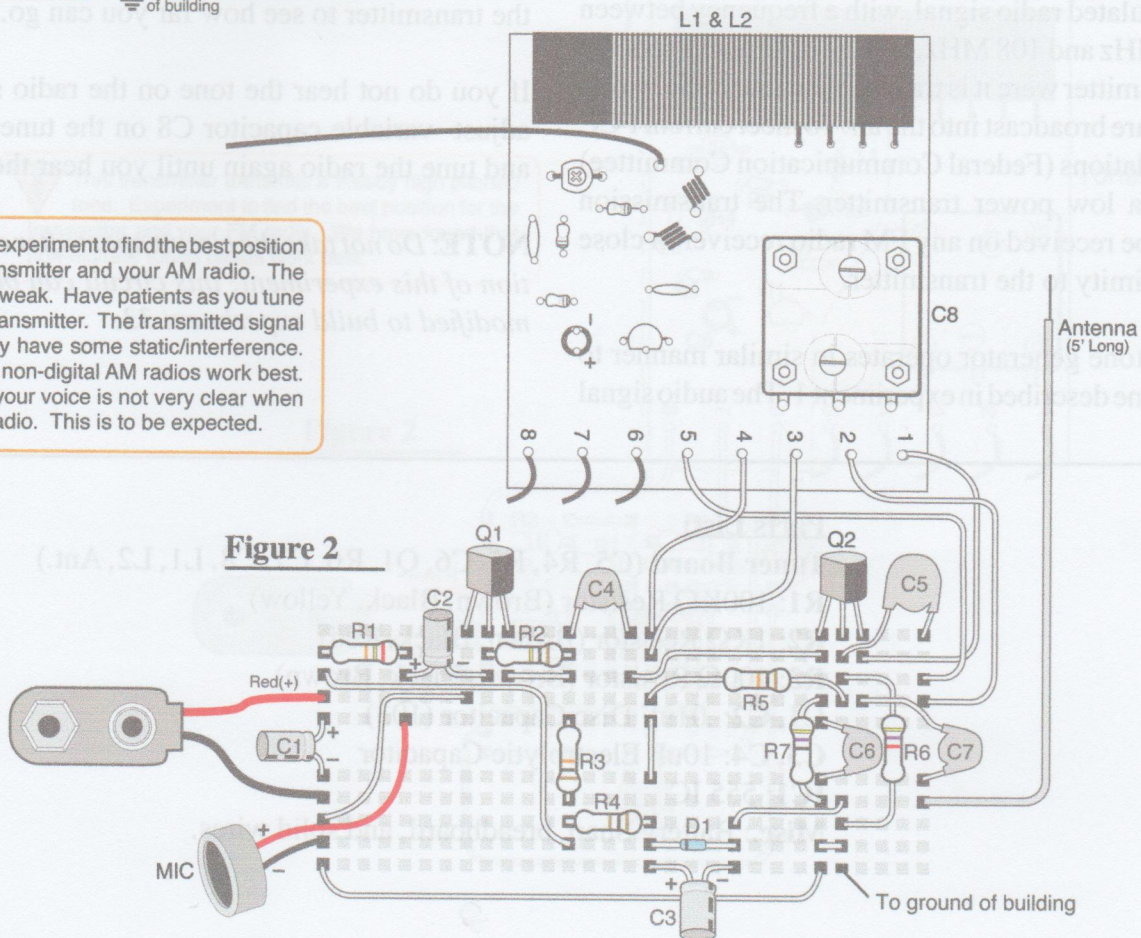

Figure 2

Experiment 32-

FM Tone Transmitter

In this experiment you will build a FM radio transmitter that transmits an audible tone in the FM radio broadcast band (88 to 108 MHz). You will be able to adjust the frequency of transmission using a variable capacitor in the LC tuned circuit. You can receive the transmission on any FM radio receiver.

Figure 1 shows the schematic diagram of the FM tone transmitter that you will build in this experiment. The tone generator section, made up of a 555 IC working as a clock (IC1), is connected to the high frequency oscillator, made with transistor Q1. The audio signal produced by the tone generator modulates by frequency the high frequency signal produced by the high frequency oscillator. This modulated radio signal, with a frequency between 88 MHz and 108 MHz, is sent to the antenna of the transmitter where it is transformed into radio waves that are broadcast into the air. To meet current FCC regulations (Federal Communication Committee) this a low power transmitter. The transmission can be received on any FM radio receiver in close proximity to the transmitter.

The tone generator operates in similar manner to the one described in experiment 1. The audio signal

produced by the tone generator is coupled by C5 to the base of transistor Q1. Transistor Q1 operates as a high frequency oscillator with a "tuned circuit" consisting of an adjustable capacitor C8 and coil L2. An antenna is attached to the collector of Q1 (output of the high frequency oscillator) by means of a load coil L1. Capacitor C7 provides the feedback necessary to sustain the oscillations.

Procedure:

- Build the circuit shown in figures 1 and 2. Notice that the components inside the dotted line in figure 1 are part of the tuner board. When done, verify that the circuit has been properly assembled.

- Connect a fresh 9V battery to the battery snap.

- Place an FM radio about 1 foot or less away from the transmitter. Turn the radio on and tune it until you hear a tone. You might hear the tone at several points on the FM band. Tune the radio to strongest reception point. Now move the radio away from the transmitter to see how far you can go.

If you do not hear the tone on the radio slightly adjust variable capacitor C8 on the tuner board and tune the radio again until you hear the tone.

NOTE: Do not take the circuit apart after completion of this experiment; this circuit can be easily modified to build experiment 33.

Parts List:

Tuner Board (C5, R4, R5, C6, Q1, R6, C7, C8, L1, L2, Ant.)

R1: 100K Ω Resistor (Brown, Black, Yellow)

R2: 1K Ω Resistor (Brown, Black, Red)

R3: 100 Ω Resistor (Brown, Black, Brown)

C1, C2: .01 μ F Disc Capacitor (103)

C3, C4: 10 μ F Electrolytic Capacitor

IC1: 555 IC

Misc.: Battery Snap, breadboard, and solid wires.

Figure 1

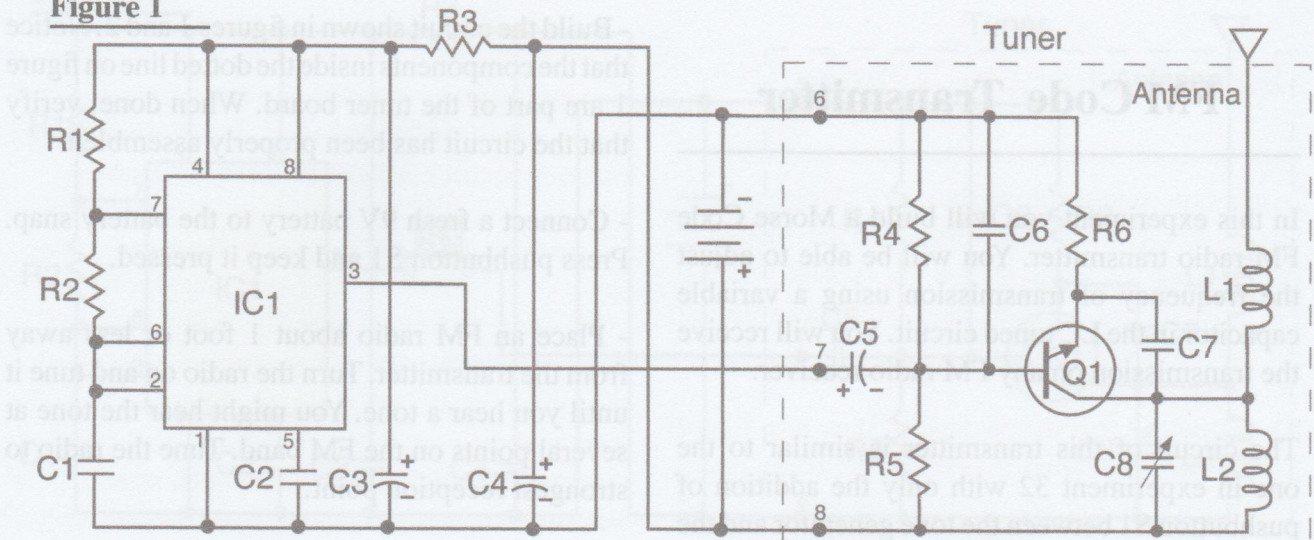

! This transmitter transmits a steady high pitched tone. Experiment to find the best position for the transmitter and your FM radio. We have found that non-digitally tuned radios work best.

Figure 2

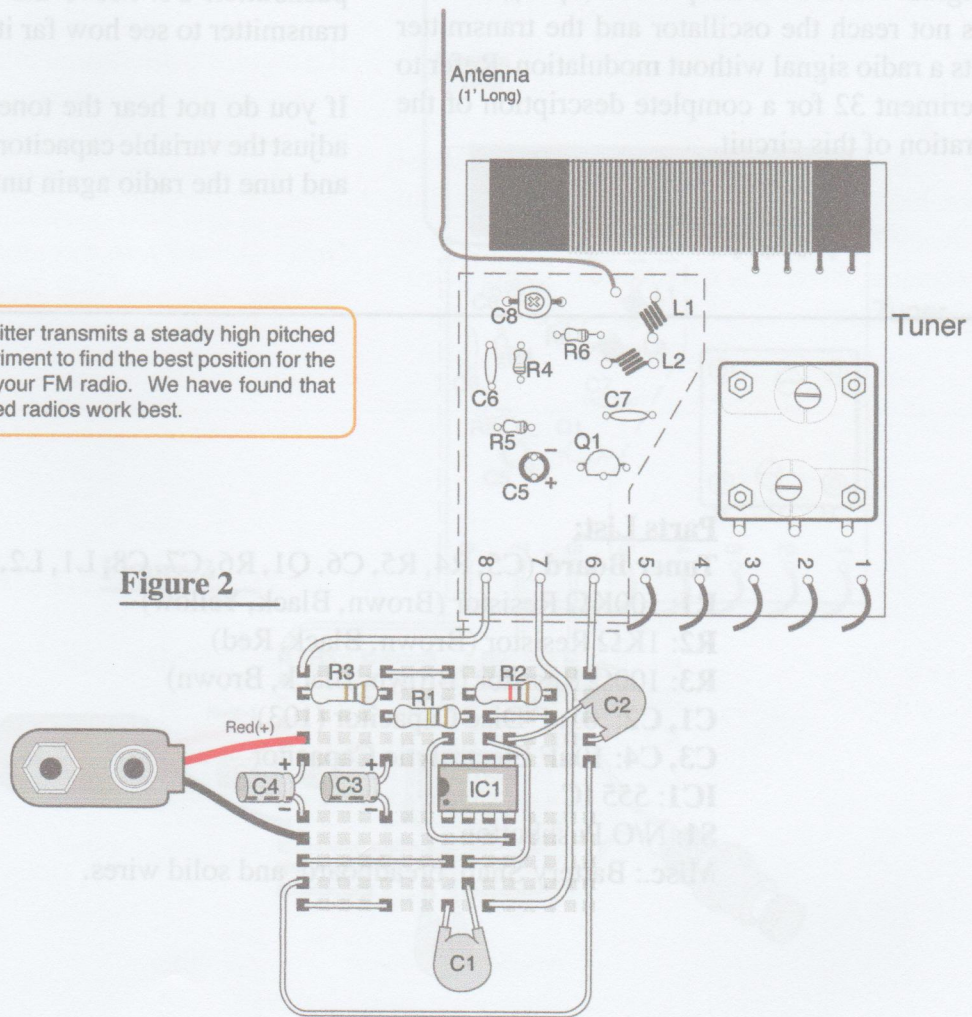

Experiment 33-

FM Code Transmitter

In this experiment you will build a Morse Code FM radio transmitter. You will be able to adjust the frequency of transmission using a variable capacitor in the LC tuned circuit. You will receive the transmission on any FM radio receiver.

The circuit of this transmitter is similar to the one in experiment 32 with only the addition of pushbutton S1 between the tone generator and the oscillator. When S1 is pressed, the tone produced by the 555 goes to the oscillator and modulates its signal. When S1 is not pressed (open), the tone does not reach the oscillator and the transmitter emits a radio signal without modulation. Refer to experiment 32 for a complete description of the operation of this circuit.

Procedure:

- Build the circuit shown in figures 1 and 2. Notice that the components inside the dotted line on figure 1 are part of the tuner board. When done, verify that the circuit has been properly assembled.
- Connect a fresh 9V battery to the battery snap. Press pushbutton S1 and keep it pressed.
- Place an FM radio about 1 foot or less away from the transmitter. Turn the radio on and tune it until you hear a tone. You might hear the tone at several points on the FM band. Tune the radio to strongest reception point.
- After you hear the tone on the radio, start generating the dashes and dots of the Morse Code with pushbutton S1. Move the radio away from the transmitter to see how far it will go.

If you do not hear the tone on the radio slightly adjust the variable capacitor C8 on the tuner board and tune the radio again until you hear the tone.

Parts List:

Tuner Board (C5, R4, R5, C6, Q1, R6, C7, C8, L1, L2, Ant.)

R1: 100K Ω Resistor (Brown, Black, Yellow)

R2: 1K Ω Resistor (Brown, Black, Red)

R3: 100 Ω Resistor (Brown, Black, Brown)

C1, C2: .01 μ F Disc Capacitor (103)

C3, C4: 10 μ F Electrolytic Capacitor

IC1: 555 IC

S1: N/O Pushbutton

Misc.: Battery Snap, breadboard, and solid wires.

Figure 1

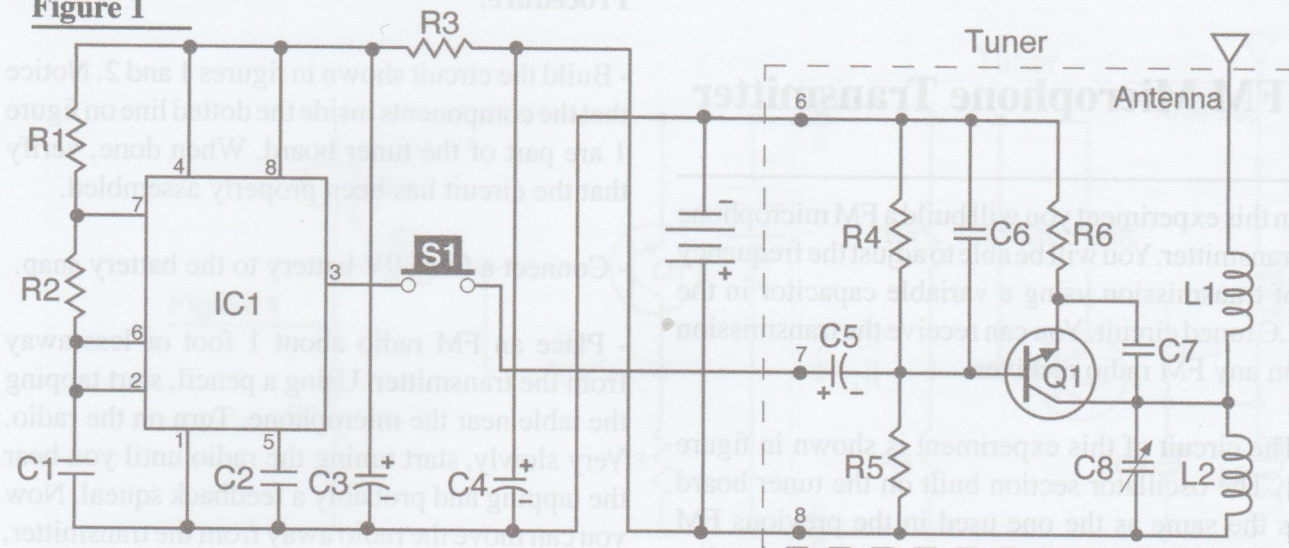
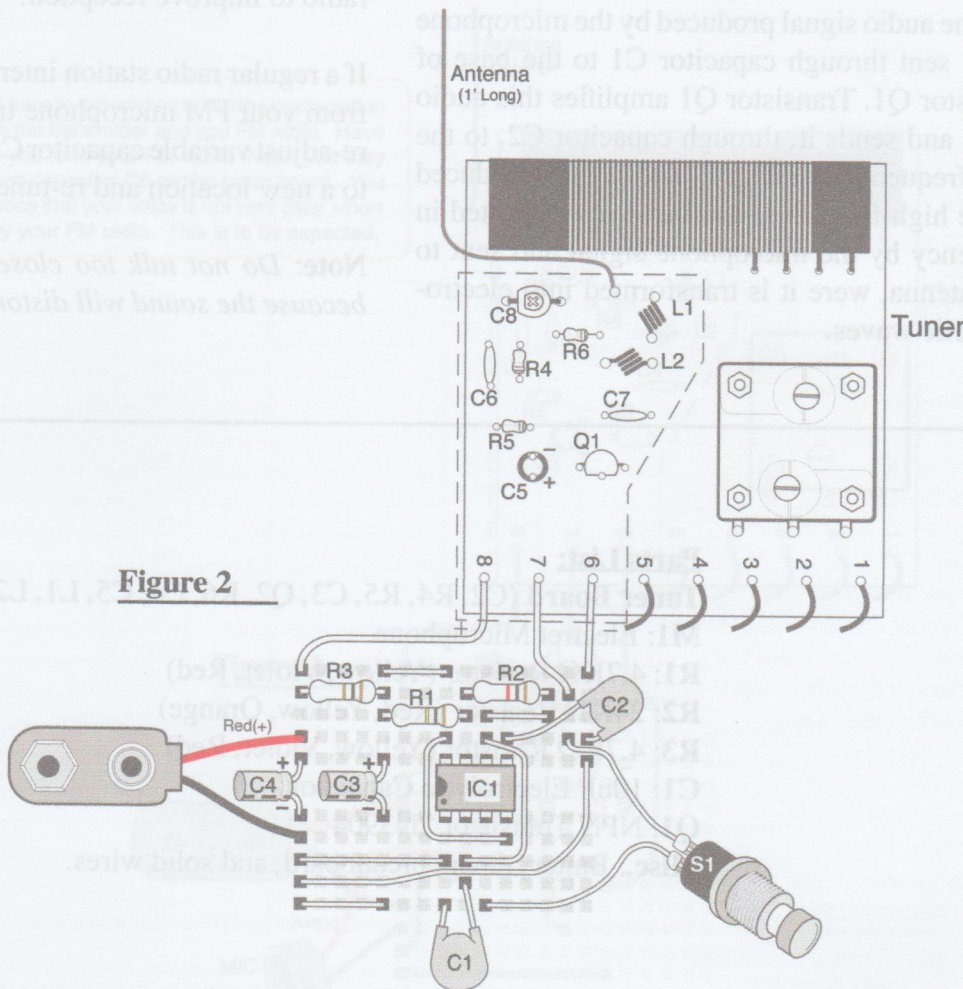

Figure 2



Experiment 34-

FM Microphone Transmitter

In this experiment you will build a FM microphone transmitter. You will be able to adjust the frequency of transmission using a variable capacitor in the LC tuned circuit. You can receive the transmission on any FM radio receiver.

The circuit of this experiment is shown in figure 1. The oscillator section built on the tuner board is the same as the one used in the previous FM transmitters. The microphone amplifier section is made up of electret microphone M1, transistor Q1, and associated components: C1, R1, R2, and R3. The audio signal produced by the microphone M1 is sent through capacitor C1 to the base of transistor Q1. Transistor Q1 amplifies this audio signal and sends it, through capacitor C2, to the high frequency oscillator. The signal produced by the high frequency oscillator is modulated in frequency by the microphone signal and sent to the antenna, where it is transformed into electromagnetic waves.

Procedure:

- Build the circuit shown in figures 1 and 2. Notice that the components inside the dotted line on figure 1 are part of the tuner board. When done, verify that the circuit has been properly assembled.
- Connect a fresh 9V battery to the battery snap.
- Place an FM radio about 1 foot or less away from the transmitter. Using a pencil, start tapping the table near the microphone. Turn on the radio. Very slowly, start tuning the radio until you hear the tapping and probably a feedback squeal. Now you can move the radio away from the transmitter, and you should be able to transmit to it with the microphone. You can do a little fine tuning on the radio to improve reception.

If a regular radio station interferes with the signal from your FM microphone transmitter, you must re-adjust variable capacitor C5, on the tuner board, to a new location and re-tune the radio.

Note: Do not talk too close to the microphone because the sound will distort.

Parts List:

Tuner Board (C2, R4, R5, C3, Q2, R6, C4, C5, L1, L2, Ant.)

M1: Electret Microphone

R1: 4.7K Ω Resistor (Yellow, Violet, Red)

R2: 24K Ω Resistor (Red, Yellow, Orange)

R3: 4.7K Ω Resistor (Yellow, Violet, Red)

C1: 10uF Electrolytic Capacitor

Q1: NPN Transistor 2N3904

Misc.: Battery Snap, breadboard, and solid wires.

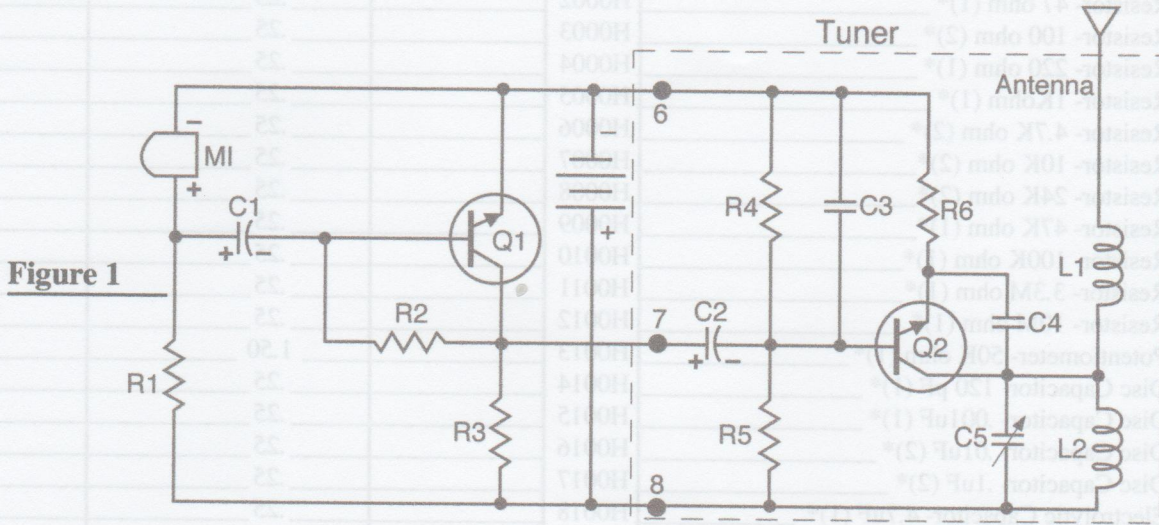

Figure 1

! You will have to experiment to find the best position for both the transmitter and your FM radio. Have patience as you tune your FM radio. Note: you may have to adjust capacitor C5 on the tuner board. You may also notice that your voice is not very clear when picked up by your FM radio. This is to be expected.

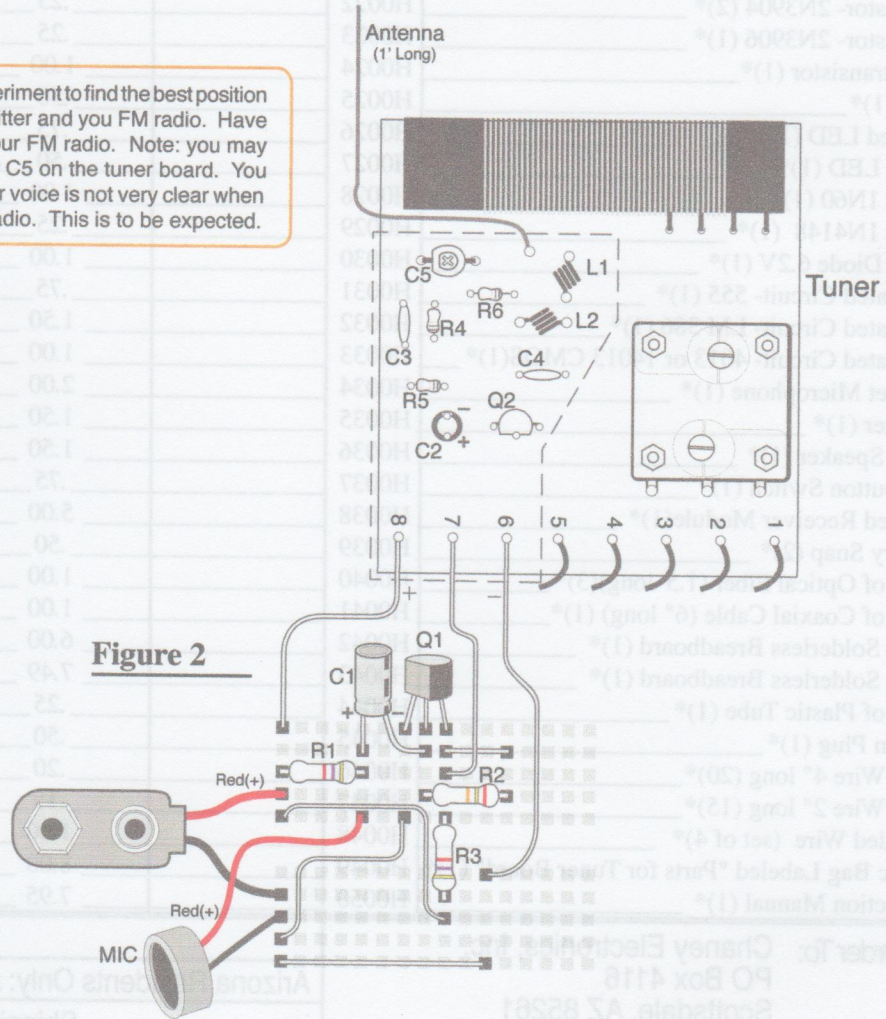

Figure 2

*Quantity in parenthesis is the total number used in this kit

REPLACEMENT PARTS ORDER FORM

C6763 - 44 in 1

Part	Part#	Qty.	Price (each)	Price (Total)
Resistor- 10 ohm (1)*	H0001		.25	
Resistor- 47 ohm (1)*	H0002		.25	
Resistor- 100 ohm (2)*	H0003		.25	
Resistor- 220 ohm (1)*	H0004		.25	
Resistor- 1Kohm (1)*	H0005		.25	
Resistor- 4.7K ohm (2)*	H0006		.25	
Resistor- 10K ohm (2)*	H0007		.25	
Resistor- 24K ohm (2)*	H0008		.25	
Resistor- 47K ohm (1)*	H0009		.25	
Resistor- 100K ohm (1)*	H0010		.25	
Resistor- 3.3M ohm (1)*	H0011		.25	
Resistor- 10M ohm (1)*	H0012		.25	
Potentiometer- 50K ohm (1)*	H0013		1.50	
Disc Capacitor- 120 pF (1)*	H0014		.25	
Disc Capacitor- .001uF (1)*	H0015		.25	
Disc Capacitor- .01uF (2)*	H0016		.25	
Disc Capacitor- .1uF (2)*	H0017		.25	
Electrolytic Capacitor- 4.7uF (1)*	H0018		.25	
Electrolytic Capacitor- 10uF (2)*	H0019		.25	
Electrolytic Capacitor- 47uF (1)*	H0020		.25	
Electrolytic Capacitor- 100uF (1)*	H0021		.25	
Transistor- 2N3904 (2)*	H0022		.25	
Transistor- 2N3906 (1)*	H0023		.25	
Phototransistor (1)*	H0024		1.00	
LED (1)*	H0025		.50	
Infrared LED (1)*	H0026		.75	
Green LED (1)*	H0027		.50	
Diode 1N60 (1)*	H0028		1.00	
Diode 1N4148 (1)*	H0029		.25	
Zener Diode 6.2V (1)*	H0030		1.00	
Integrated Circuit- 555 (1)*	H0031		.75	
Integrated Circuit- LM 386 (1)*	H0032		1.50	
Integrated Circuit- 4013 or 14013 CMOS(1)*	H0033		1.00	
Electret Microphone (1)*	H0034		2.00	
Speaker (1)*	H0035		1.50	
Piezo Speaker (1)*	H0036		1.50	
Pushbutton Switch (1)*	H0037		.75	
Infrared Receiver Module(1)*	H0038		5.00	
Battery Snap (2)*	H0039		.50	
Piece of Optical Fiber (1.5' long)(3)*	H0040		1.00	
Piece of Coaxial Cable (6" long) (1)*	H0041		1.00	
Small Solderless Breadboard (1)*	H0042		6.00	
Large Solderless Breadboard (1)*	H0043		7.49	
Piece of Plastic Tube (1)*	H0044		.25	
3.5mm Plug (1)*	H0045		.50	
Solid Wire 4" long (20)*	H0046		.20	
Solid Wire 2" long (15)*	H0047		.15	
Stranded Wire (set of 4)*	H0048		1.00	
Plastic Bag Labeled "Parts for Tuner Board" (1)*	H0049		8.00	
Instruction Manual (1)*	H0050		7.95	

Mail Order To: Chaney Electronics, Inc. PO Box 4116 Scottsdale, AZ 85261 Fax Order To: 480-451-9495 or Phone Order To: 1-800-227-7312 or 480-451-9407	Subtotal			
	Arizona Residents Only: Add Sales Tax			
	Shipping & Handling			9 00
	TOTAL OF ORDER			

Permission given to photocopy this page only.

©1997 Chaney Electronics; Inc.



